

MIRAGE BOOK

.24

www.mirage.it

MIRAGE[®]
INSPIRING BETTER LIVING

MIRAGE BOOK
2024

INSPIRING BETTER LIVING





[EN]

Right from the beginning, we've devoted our efforts to exploring and promoting porcelain stoneware, a material that teams beauty with versatility.

We are deeply bound to the Italian ceramic tradition, and have invested pride and passion in carrying forward this heritage in over 150 countries worldwide.

As ambassadors of Italian craftsmanship, our commitment to providing sustainable solutions for the well-being of the community and the environment is a model of excellence.

We are Mirage, the company where each ceramic surface has a story to tell, bursting with beauty and passion.

[DE]

Seit unserer Firmengründung widmen wir uns mit großer Hingabe der Erforschung und Valorisierung des Feinsteinzeugs, eines Materials, das die ästhetische Schönheit mit der Vielseitigkeit verbindet.

Wir fühlen eine tiefe Verbundenheit mit der italienischen Keramiktradition und geben dieses Erbe stolz in mehr als 150 Ländern in der ganzen Welt weiter.

Als Botschafter des „Made in Italy“ stellt unser Engagement in der Fertigung von nachhaltigen Lösungen zum Wohl der Gemeinschaft und der Umwelt ein Musterbeispiel dar.

Wir sind Mirage, die Firma, in der die Keramik zur Erzählung wird und in der jede Oberfläche eine Geschichte voll Leidenschaft und Schönheit erzählt.

[FR]

Dès nos débuts, nous nous sommes plongés avec dévouement dans l'exploration et la valorisation du grès cérame, un matériau qui allie la beauté esthétique à la versatilité.

Profondément liés à la tradition céramique Made in Italy, c'est avec orgueil et passion que nous avons transmis cet héritage à plus de 150 pays du monde entier.

En tant qu'ambassadeurs du Made in Italy, notre engagement dans la réalisation de solutions durables pour le bien-être de la communauté et de l'environnement représente un paradigme d'excellence.

Nous sommes Mirage, l'entreprise dans laquelle la céramique se transforme en narration et où chaque surface raconte une histoire riche en passion et en beauté.

[ES]

Desde nuestros inicios, nos dedicamos a explorar y desarrollar el gres porcelánico, un material que combina belleza estética y versatilidad.

Arraigados profundamente en la tradición cerámica Made in Italy, con orgullo y pasión hemos continuado este legado en más de 150 países de todo el mundo.

En calidad de embajadores del Made in Italy, nuestro compromiso en hacer soluciones sostenibles para el bienestar de la comunidad y del medioambiente representa un paradigma de excelencia.

Somos Mirage, la empresa que transforma la cerámica en una narración y donde cada superficie cuenta una historia que desprende pasión y belleza.

[RU]

С самого начала нашей деятельности нас увлекло исследование и раскрытие потенциала керамического гранита – материала, соединяющего в себе эстетическую красоту и универсальность.

Глубоко связанные с традициями керамики Made in Italy, мы с гордостью и любовью принесли это наследие в 150 стран мира. Наше обязательство, в качестве послов Made in Italy, по реализации устойчивых решений на благо сообщества и окружающей среды является прекрасным примером.

Мы – это компания Mirage, где керамика превращается в повествование и где каждая облицовочная поверхность становится увлекательным и прекрасным рассказом.

[中國]

自公司成立之初，我们就致力于探索和改进陶瓷石器这种集美观与多功能于一身的材料。

我们深深扎根于“意大利制造”的陶瓷传统，带着自豪和激情，我们在全球 150 多个国家和地区延续着这一传统。

作为“意大利制造”的代言人，我们致力于为社区和环境的福祉提供可持续的解决方案，这代表了一种卓越的典范。

我们是 Mirage 公司，在这里，陶瓷成为一种叙事方式，每一个表面都在讲述一个充满激情和美丽的故事。

Fin dai nostri esordi, ci siamo immersi con dedizione nell'esplorazione e valorizzazione del gres porcellanato, un materiale che unisce la bellezza estetica alla versatilità. Profondamente legati alla tradizione **ceramica Made in Italy**, è con orgoglio e passione che abbiamo portato avanti quest'eredità in oltre 150 Paesi nel Mondo.

Come ambasciatori del Made in Italy, il nostro impegno nella realizzazione di soluzioni sostenibili per il benessere della comunità e dell'ambiente rappresenta un paradigma di eccellenza.

Siamo Mirage, l'azienda in cui **la ceramica si trasforma in narrazione** e dove ogni **superficie racconta una storia** ricca di passione e bellezza.

MIRAGE BOOK 2024

INDEX

Indice | Inhaltsverzeichnis | Index | Indice | Указатель | 索引

OUR COMPANY

La nostra Azienda | Unser Unternehmen | Notre entreprise | Nuestra empresa | О нашей компании | 公司简介

10

OUR SUSTAINABILITY STRATEGY

Certificazioni | Zertifizierung | Certifications | Certificaciones | Сертификаты | 认证

26

6MM 600X1200

34

ENGINEERING DIVISION

Divisione Engineering | Abteilung Engineering | Division Engineering | División Engineering | Подразделение инжиниринга | 工程部门

36

OUTDOOR SOLUTIONS

Soluzioni outdoor | Outdoor-Lösungen | Solutions pour l'extérieur | Soluciones outdoor | Решения для наружных работ | 户外解决方案

40

100% SLABS

48

100% BATHROOM

54

PROJECT BATHMOOD

56

COLLECTIONS

Collezioni | Kollektionen | Collections | Colecciones | Коллекции | 系列

62

Clay	64	Kao	264	Officine	414
Cosmopolitan	82	Koru	282	Oudh	422
Dijon	100	Lemmy	292	Papier	440
Easyway	116	Mand	308	Quarziti 2.0	456
Elysian	120	Môtley	320	Rail	468
Elysian Travertini	138	Na.me	338	Reflet	476
Emporio 225	158	Nau 2.0	348	Signature	488
Glocal	182	Noon	356	Silverlake	498
Jewels	214	Norr	368	Viceversa	510
Jolie	234	Novemb3r	388	Wanderlust	528
Jurupa	252	Nyuma	400		

TECHNICAL INFORMATION

Mirage° informa | Mirage° informiert | Mirage° informe | Mirage° informa | Mirage° сообщает | Mirage° 通知

544

MIRAGE BOOK
2024

WE ARE
MIRAGE®

Noi siamo Mirage® | Wir sind Mirage® | À propos de Mirage®
Somos Mirage® | Мы - это компания Mirage® | 我们是 Mirage®

DESIGN, STRATEGY AND INNOVATION. WORLDWIDE.

our COMPANY

MIRAGE

Mirage® è una realtà internazionale che da oltre 50 anni **progetta e realizza pavimenti e rivestimenti in gres porcellanato** per spazi commerciali, pubblici e residenziali.



Pavullo Headquarter - Italy



Pavullo Headquarter - Italy

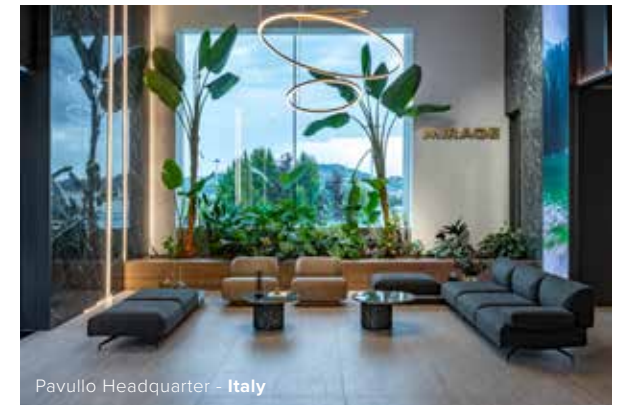

Pavullo Headquarter - Italy



Pavullo Headquarter - Italy

[EN]
A solid, international company which has been **designing and manufacturing porcelain stoneware wall and floor coverings** for commercial, public and residential use for over 50 years.

[DE]
Ein solides internationales Unternehmen, das seit über 50 Jahren **Fußböden und Verkleidungen aus Feinsteinzeug** für Gewerbebereiche, öffentliche Räume und den Wohnbereich **plant und fertigt**.

[FR]
Une réalité internationale solide qui, depuis plus 50 ans, **conçoit et réalise des sols et des revêtements de murs en grès cérame** pour des espaces commerciaux, publics et résidentiels.

[ES]
Una consolidada realidad internacional que, desde más 50 años, **diseña y realiza pavimentos y revestimientos de gres porcelánico** para espacios comerciales, públicos y residenciales.

[RU]
Известная на международном рынке компания, которая вот уже 50 лет, как **разрабатывает и изготавливает напольную и настенную плитку из керамического гранита** для торговых, общественных и жилых помещений.

[中國]
Mirage® 是一家国际企业, 50 年来, 一直为商业、公共和住宅空间**设计和制造瓷质地砖和墙砖**。

Con un perfetto mix fra **capacità produttiva, sperimentazione e sostenibilità**, abbiamo costruito la nostra riconoscibilità nel mondo.

Un'identità tutta italiana, dove creatività e costante ricerca tecnologica definiscono il valore di ogni prodotto, rendendolo unico ed esclusivo.



Cairo Mirage Project Point



Milano Mirage Project Point



León Mirage Project Point



Dubai Mirage Project Point



San José Mirage Project Point



Moscow Mirage Project Point



San Juan Mirage Project Point

[EN]
With a perfect mix of **production capacity, experimentation and sustainability**, we have made a name for ourselves worldwide, constructing a 100% **Italian identity** in which **creativity**, teamed with **ongoing technological research**, defines the value of **each product**, making it unique and exclusive.

[DE]
Mit einer perfekten Mischung aus **Produktionskapazität, Experimentierfreudigkeit und Nachhaltigkeit** haben wir unsere Identität aufgebaut, die uns in der ganzen Welt erkennbar macht. **Eine durch und durch italienische Identität**, bei der die **Kreativität** und ständige **technologische Forschung** für den **Wert jedes Produkts** ausschlaggebend sind und es einmalig und exklusiv machen.

[FR]
Grâce à une parfaite alliance entre **capacité de production, expérimentation et durabilité**, nous avons forgé notre notoriété dans le monde entier. **Une identité entièrement italienne**, où la **créativité** et la **recherche technologique** constante définissent **la valeur de chaque produit**, en le rendant unique et exclusif.

[ES]
Con una mezcla perfecta de **productividad, experimentación y sostenibilidad**, hemos conseguido que nuestros productos sean reconocibles en todo el mundo. **Una identidad totalmente italiana**, en la que **creatividad** y constante **investigación tecnológica** definen **el valor de cada producto**, haciéndolo único y exclusivo.

[RU]
Благодаря отличному сочетанию **производственных возможностей, экспериментирования и экологичности**, мы построили узнаваемость нашей марки в мире. Это **полностью итальянская идентичность**, в которой **креативность** и постоянный **поиск новых технологий** определяют **значимость каждого продукта**, делая его уникальным и эксклюзивным.

[中國]
凭借**生产能力、实验和可持续性**的完美结合，我们在世界范围内建立了自己的知名度。我们的**产品是百分百意大利制造**，出色的**创造力和不断的技术研究**定义了**每一产品的价值**，令它们**独一无二、与众不同**。

TURNING IDEAS INTO MATERIALS

our MISSION



INSPIRING BETTER LIVING

design for
BETTER LIFE



I più attuali temi dell'architettura e del design confermano come la **qualità di vita** sia ormai divenuto un **valore democratico, raggiungibile e quotidiano.**

In questi anni Mirage® si è impegnata a creare un "progetto completo", che parte dalla creazione di **materiali di design a basso impatto ambientale**, per giungere ad un concetto più ampio di soluzioni al servizio della creatività, del benessere sociale e della sostenibilità.

Il nuovo payoff di Mirage® - **Inspiring better living** - rispecchia infatti la volontà di adottare un comportamento che sia anche di ispirazione per la comunità, consci del fatto che le nostre azioni possono fare la differenza.

[EN]

Current architectural and design trends show that quality of life is now considered a **democratic, attainable and everyday value.**

In recent years, Mirage® has been dedicating itself to creating a "complete project" that starts with producing eco-friendly design materials and leads to a wider range of solutions that support creativity, social well-being and sustainability.

The new Mirage® pay off - Inspiring better living - reflects the company's desire to adopt a behaviour that is also an inspiration to the community, aware that individual actions can make a significant difference.

[DE]

Die aktuellsten Themen der Architektur und des Designs bestätigen, dass die Lebensqualität mittlerweile zu einem **demokratischen, zugänglichen und alltäglichen Wert** geworden ist. In diesen Jahren hat sich Mirage® dafür engagiert, ein „komplettes Projekt“ zu schaffen, das bei der Schaffung von umweltfreundlichen Designmaterialien beginnt und zu einem breiteren Konzept von Lösungen im Dienst der Kreativität, des sozialen Wohlergehens und der Nachhaltigkeit ausgebaut wird.

Der neue Claim von Mirage® - Inspiring better living - spiegelt auch den Willen wider, mit dem eigenen Verhalten zum Vorbild für die Gemeinschaft werden, da wir uns bewusst sind, dass unsere Handlungen den Unterschied machen können.

[FR]

Les thèmes de l'architecture et du design les plus actuels confirment bien que la qualité de vie est désormais devenue une **valeur démocratique, accessible et quotidienne.**

Au cours de ces années, l'entreprise Mirage® s'est engagée à créer un "projet complet", qui part de la création de matériaux de design à impact environnemental réduit pour aboutir à un concept plus vaste de solutions au service de la créativité, du bien-être social et de la durabilité.

Le nouveau payoff de Mirage® - Inspiring better living - reflète, en effet, la volonté d'adopter un comportement qui inspirerait aussi la communauté, conscients du fait que nos actions peuvent faire la différence.

[ES]

Los temas más actuales de arquitectura y diseño confirman que la calidad de vida se ha convertido en un **valor democrático, alcanzable y cotidiano.** En los últimos años, Mirage® se ha dedicado a realizar un «proyecto completo» que comienza con la creación de materiales de diseño de bajo impacto ambiental, para llegar a un concepto más amplio de soluciones al servicio de la creatividad, el bienestar social y la sostenibilidad.

El nuevo payoff de Mirage® - Inspiring better living - refleja el deseo de adoptar un comportamiento que también sirva para inspirar a la comunidad, sabiendo que nuestras acciones pueden marcar la diferencia.

[RU]

Самые актуальные темы архитектуры и дизайна подтверждают тот факт, что **качество жизни стало уже доступной и повседневной демократической ценностью.**

В эти годы компания Mirage® взяла на себя обязательство осуществить «полный проект», начинающийся от создания дизайнерских материалов с низким негативным воздействием на окружающую среду до разработки более широкой концепции решений на службе креативности, социального благополучия и устойчивого развития. Новый слоган компании Mirage® - Inspiring better living - действительно отражает желание действовать таким образом, что бы это было примером для общества, с полным осознанием того, что наши действия могут оказывать большое влияние.

[中國]

建筑和设计的最新主体证实，**生活质量现在已经成为一种民主的、可实现的和普遍的价值。**

近年来，Mirage®一直致力于创建一个“完整的项目”，从创造对环境影响较小的设计材料开始，最终形成一个更广泛的解决方案概念，为创造力、社会福利和可持续性服务。

新的Mirage®品牌标语--Inspiring better living--事实上反映了采取一种行为的愿望，也是对社会的一种激励，意识到我们的行动可以带来改变。

Mirage® vanta un sistema produttivo all'avanguardia che, unitamente agli elevati standard professionali delle nostre persone ed alla completezza di gamma prodotti, soddisfa al meglio tutte le esigenze progettuali e commerciali.

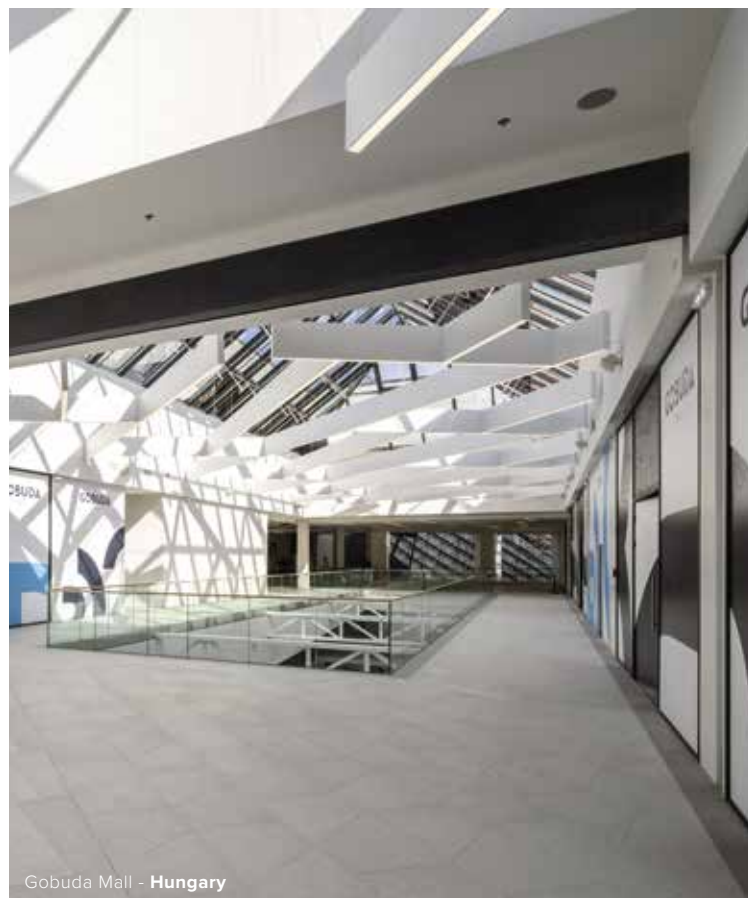

Gobuda Mall - Hungary



Mansard Hotel - Saudi Arabia

[EN]
Mirage's cutting-edge production system combined with the high level of expertise and professionalism of the business units and comprehensive range of products allows it to effectively meet all design and commercial requirements.

[DE]
Mirage® verfügt über ein wegweisendes Produktionssystem, das zusammen mit den hohen professionellen Standards der Geschäftsbereiche und der Vollständigkeit der Produktpalette allen gestalterischen und kommerziellen Anforderungen gerecht wird.

[FR]
Mirage® s'appuie sur un système de production ultra moderne qui, associé aux standards professionnels élevés des unités commerciales et à une gamme de produits complète, satisfait de manière optimale les exigences commerciales et de conception.

[ES]
Mirage® posee un sistema de producción de vanguardia que, junto con los altos estándares profesionales de las divisiones de la empresa y la integridad de la gama de productos, cumple de la mejor manera con todos los requisitos de diseño y comerciales.

BUILDING SPACES, SKILLS, INTERACTIONS

our ORGANIZATION



WE ARE PORCELAIN NATIVES *and SOLUTION MAKERS

exporting OUR
KNOW-HOW

Con una rete commerciale estesa a 160 paesi, entriamo quotidianamente in contatto con mercati e contesti socioculturali differenti in cui, **prima dei nostri prodotti, offriamo il nostro know how.**

Una politica che porta i suoi frutti, come provato dai progetti realizzati e dalle certificazioni internazionali acquisite.

Sono queste le testimonianze del "Made in Italy" che esportiamo: la capacità di rinnovare e reinventare lo spirito radicato nelle nostre tradizioni unitamente alla qualità dei nostri prodotti in costante progresso.



Private House - Costa Rica



Restaurant @ Fairmont Hotel - Egypt

[EN]
Every day, with a network that stretches over 160 countries, we come into contact with different markets and socio-cultural contexts, in which we offer our know-how, even more than our products.
This policy has proved positive, as demonstrated by the projects undertaken and the international certifications obtained.
This is the proof of the "Made in Italy" model we export: **the ability to innovate and to reinvent the spirit rooted in our traditions, together with the constantly improving quality of our products.**

[DE]
Dank eines verzweigten Netzes in 160 Ländern treten wir täglich mit den unterschiedlichen Märkten und soziokulturellen Umfeldern in Kontakt, in denen wir **nicht nur unsere Produkte, sondern allen voran unser Know-how** anbieten.
Eine Politik, die fruchtbringend ist, wie die umgesetzten Projekte und erzielten internationalen Zertifizierungen beweisen.
Das sind die Zeugnisse der Produktion im Stil „Made in Italy“, die wir exportieren: **die Fähigkeit, den in unseren Traditionen verwurzelten Esprit unter Gewährleistung der ständig wachsenden Qualität unserer Produkte zu erneuern und neu zu erfinden.**

[FR]
Avec un réseau couvrant 160 pays, nous entrons quotidiennement en contact avec des marchés et des contextes socioculturels différents sur lesquels, **avant même nos produits, nous offrons notre savoir-faire.**
Une politique qui porte ses fruits, comme le démontrent les projets réalisés et les certifications internationales obtenues.
Autant d'expressions du "Made in Italy" que nous exportons : **la capacité de renouveler et de réinventer l'esprit ancré dans nos traditions en même temps que la qualité de nos produits en continue évolution.**

[ES]
Con una red que abarca 160 países, entramos diariamente en contacto con mercados y contextos socioculturales diferentes en los cuales, **antes que nuestros productos, ofrecemos nuestro know how.**
Una política que da sus frutos, como lo demuestran los proyectos realizados y las certificaciones internacionales obtenidas.
Estos son los testimonios del "Made in Italy" que exportamos: **la capacidad de renovar y reinventar el espíritu arraigado en nuestras tradiciones junto a la calidad de nuestros productos en constante evolución.**

[RU]
Благодаря сети, присутствующей в 160 странах, мы ежедневно вступаем в контакт с различными рынками и социально-культурными контекстами, где **прежде чем предложить нашу продукцию, мы предлагаем наше ноу-хау.**
Такая политика приносит свои плоды, как это доказывают реализованные проекты и полученные международные сертификаты.
Вот свидетельство, характеризующее экспортируемую нами продукцию "Made in Italy": **способность обновлять и переосмысливать дух наших традиций одновременно с постоянно растущим качеством наших изделий.**

[中國]
凭借遍布160个国家的销售网络，我们每天接触不同的市场和社会文化背景，**在向这些市场输出我们的产品之前，我们输出我们的专业知识。**
这项政策取得了丰硕成果，正如所实施的项目和获得的国际认证所证明的那样，这些国际认证包括：我们出口的“意大利制造”产品，**不仅体现了我们更新和重塑在我们的传统中根深蒂固的精神的能力，在我们不断进步的产品质量中也可可见一斑。**

Proponiamo **soluzioni integrate** di pavimentazione e rivestimento, applicazioni tecniche, facciate ventilate, pavimentazione sopraelevata, pavimenti tattili e superfici per esterni.



Luxury Residence - Switzerland



Hay Boutique Hotel - Ukraine

Un'offerta completa e trasversale, supportata da oltre **30 collezioni** combinabili in un'ampia gamma di **formati,**

colori e superfici per la progettazione di ogni spazio commerciale e residenziale.

[EN]
We offer **integrated solutions** for flooring and cladding, technical applications, ventilated facades, raised floors, tactile floors and outdoor surfaces. A complete and wide-ranging offer, supported by more than **30 collections** that can be mixed and matched with a wide range of **sizes, colours and finishes** to design any type of commercial and residential space.

[DE]
Wir bieten **integrierte Lösungen** für Bodenbeläge und Wandverkleidungen, technische Anwendungen, hinterlüftete Fassaden, Doppelböden, taktile Böden und Bodenbeläge für den Außenbereich. Ein komplettes und vielseitiges Angebot, unterstützt durch mehr als **30 Kollektionen**, die sich in einer Vielzahl von **Formaten, Farben und Oberflächen** für die Gestaltung jedes Geschäfts- und Wohnraums kombinieren lassen.

[FR]
Nous proposons des **solutions intégrées** pour revêtements de sols et muraux, des applications techniques, des façades ventilées, des planchers surélevés, des sols tactiles et des surfaces pour l'extérieur. Une offre complète et transversale, comprenant plus de **30 collections** à combiner avec un large éventail de **formats, couleurs et surfaces**, pour la conception de tout type d'espace commercial et résidentiel.

[ES]
Ofrecemos **soluciones integradas** para pavimentos y revestimientos, aplicaciones técnicas, fachadas ventiladas, pavimentos elevados, pavimentos táctiles y superficies para exteriores. Una oferta completa y transversal, respaldada por más de **30 colecciones** que se pueden combinar en una amplia gama de **formatos, colores y superficies** para el proyecto de cualquier espacio comercial y residencial.

[RU]
Предлагаем **интегрированные решения** для облицовки полов и стен, вентилируемых фасадов, настилов на приподнятой конструкции, рельефных тактильных покрытий и для наружных работ. Полное и многофункциональное предложение, поддерживаемое более чем **30 коллекциями**, комбинируемыми между собой и предлагаемыми в широком ассортименте **форматов, цветов и фактур** для осуществления любого проекта торгового и жилого помещения.

[中國]
我們提供地磚和牆磚、技術應用、通風幕牆、活動地板、盲道地磚和室外表面等**綜合解決方案**。產品種類齊全，備有**30多個系列**，各種**尺寸、顏色和表面**可以進行多樣化的搭配，用於任何商業和住宅空間的設計。



SHAPE YOUR IDEA

MIRAGE® is the most reliable **DESIGN PARTNER**

THE VALUE OF MADE IN ITALY

when DESIGN and
RELIABILITY mean GREAT
CARE for HEALTH and
ECO-SUSTAINABILITY



Per noi **Made in Italy** non è una semplice etichetta di origine, ma **espressione di valori concreti**. Parliamo di **creatività, etica, responsabilità e trasparenza** verso i nostri stakeholder, i nostri lavoratori, il territorio e l'ambiente.

Essere protagonisti del Made in Italy significa garantire innanzitutto la qualità di prodotto unico, che racchiude in sé tutte le doti di capacità estetica, creatività, ingegno ed innovazione tecnologica che da sempre contraddistinguono la ceramica italiana nel mondo.

In Mirage®, l'operare con trasparenza nei confronti di tutti gli interlocutori è considerato un valore imprescindibile e fondamentale.

[EN]

For us, "**Made in Italy**" is more than just a label of origin, it is an **expression of authentic values**. We are talking about **creativity, ethics, responsibility and transparency** towards our stakeholders, our workers, the territory and environment. Being a protagonist of "Made In Italy" means guaranteeing a unique, high-quality product that embodies all the aesthetic ability, creativity, research and technological innovation that has always distinguished Italian ceramics worldwide. Mirage® regards transparency as an essential and fundamental value in all its dealings, from customers and suppliers to employees.

[DE]

Made in Italy ist für uns kein einfaches Ursprungsetikett, sondern **Ausdruck konkreter Werte**. Wir sprechen von **Kreativität, Ethik, Verantwortung und Transparenz** gegenüber unseren Stakeholdern, den Mitarbeitern, dem Territorium und der Umwelt. Als wichtiger Hersteller des Made in Italy gewährleisten wir vor allem die Qualität eines einzigartigen Produkts, was sich in ästhetischen Eigenschaften, Kreativität, Erfindungsgabe und technologischer Innovation ausdrückt, die die italienische Keramik seit jeher in der Welt auszeichnen. Bei Mirage® wird ein transparentes Verhalten gegenüber allen Gesprächspartnern als unabdingbarer und fundamentaler Wert verstanden.

[FR]

Pour nous, le « **Made in Italy** » ne se résume pas à quelques mots sur une étiquette indiquant le pays d'origine. C'est l'**expression de valeurs concrètes**. Nous parlons de **créativité, d'éthique, de responsabilité et de transparence** vis-à-vis de parties prenantes, de nos employés, du territoire et de l'environnement. Être un acteur du « **Made in Italy** », c'est tout d'abord garantir une qualité de produit unique, renfermant toutes les qualités esthétiques, de créativité, d'ingéniosité et d'innovation technologique qui ont toujours distingué la céramique italienne dans le monde entier. Chez Mirage®, être transparent vis-à-vis de ses interlocuteurs est une valeur essentielle et incontournable.

[ES]

Para nosotros, **Made in Italy** no es solo una etiqueta de origen, sino una **expresión de valores concretos** que son la **creatividad, ética, responsabilidad y transparencia** hacia los stakeholders, el personal, el territorio y el medio ambiente. Ser protagonistas del Made in Italy significa, ante todo, asegurar la cualidad de ser un producto único, que encarna todas las virtudes de capacidad estética, creatividad, ingenio e innovación tecnológica que caracterizan a la cerámica italiana en el mundo. En Mirage®, trabajar de manera transparente con todas las partes interesadas se considera un valor indispensable y fundamental.

[RU]

Для нас «**Made in Italy**» – это не просто этикетка, указывающая происхождение, а **выражение конкретных ценностей**. Это такие понятия, как **креативность, этика, ответственность и прозрачность** по отношению к участникам проекта, нашим сотрудникам, территории и окружающей среде. Быть изготовителем продукции «Made in Italy» – означает прежде всего гарантировать качество уникального продукта, заключающего в себе все достоинства эстетики, креативности, изобретательности и технологической инновации, всегда отличавшие итальянскую керамику в мире. В компании Mirage® критерий прозрачности в отношениях со всеми сторонами считается основной и неотъемлемой ценностью.

[中國]

对我们来说，“**意大利制造**”不是一个简单的原产地标签，而是一个**具体价值的体现**，涉及创造力、道德、对我们的持股人、工人、领土和环境的**责任和透明度**。我们谈论创造力、道德、责任和对我们的利益相关者、我们的工人、领土和环境的透明度。作为“意大利制造”的重要企业，首先就是要保证某种独特产品的品质，其中蕴含了所有的审美、创意、独创性和技术创新能力，一直以来是意大利陶瓷驰名世界、与众不同的特点。在Mirage®，透明地与所有利益相关者合作，被认为是不可缺少的基本价值。

Il gres porcellanato Mirage® è un materiale compatto e resistente.

Le lastre sono ottenute attraverso un processo di greificazione, ovvero la completa fusione in un unico materiale di sabbie, quarzi, feldspati, caolini, argille e ossidi coloranti naturali: si tratta di materie prime che, cotte a temperature superiori ai 1200°C, arrivano a costituire un prodotto a tutta massa di **eccezionale durezza**, dalle **caratteristiche meccaniche ineguagliabili**.

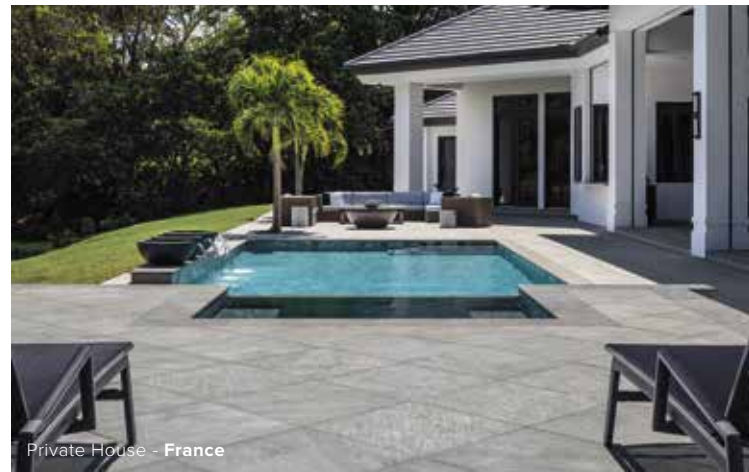

Private House - France

CARATTERISTICHE DEL PRODOTTO

- È un materiale **inassorbente**: è quindi più facile da pulire rispetto a materiali alternativi, non emette e non assorbe odori.
- È **incombustibile** e **non genera sostanze tossiche** a nessuna temperatura.
- È **resistente** ai diversi agenti atmosferici: oltre ad essere ingelivo, è composto da materiali inorganici ed il colore non viene influenzato dai raggi UV.
- È **riciclabile**: il 100% dello scarto crudo viene riutilizzato per la produzione delle collezioni in una percentuale tra il 10% e 60%. Lo scarto del materiale cotto può essere utilizzato come materiale inerte per l'edilizia.
- Ha un'elevata **resistenza ai graffi ed all'usura**, maggiore di qualsiasi altro materiale da rivestimento.

UN PRODOTTO SICURO

- È il prodotto ideale per il riscaldamento a pavimento in quanto conduce il calore e non isola. Inoltre non emette sostanze nocive a qualsiasi temperatura.
- Non emette Radon.
- Non rilascia piombo.
- Non rilascia VOC.
- Non contiene formaldeide ed amianto.
- È inospitale per polvere, batteri ed allergeni.

[EN]

Mirage® porcelain stoneware is a **compact and resistant material**. The slabs are obtained through a vitrification process, i.e. the complete fusion of sand, quartz, feldspar, kaolin, clay and natural colouring oxides to form a single material: these raw materials are fired at temperatures above 1200°C to create a compact and solid product with **exceptional hardness and unparalleled mechanical properties**.

[DE]

Mirage®-Feinsteinzeug ist ein **kompaktes und widerstandsfähiges Material**. Die Platten werden in einem speziellen Sinterverfahren hergestellt, das heißt, die vollständige Verschmelzung von Sanden, Quarzen, Feldspaten, Kaolinen, Tonen und natürlichen Farboxiden in einem einzigen Material: Es handelt sich um Rohstoffe, die bei Temperaturen über 1200°C gebrannt werden, so entsteht eine vollgemischte Keramikfliese von außergewöhnlicher **Härte** und mit **beispiellosen Festigkeitswerten**.

[FR]

Le grès cérame Mirage® est un **matériau compact et résistant**. Les plaques sont obtenues par un procédé de vitrification, c'est-à-dire par fusion complète dans un unique matériau de sables, quartz, feldspaths, kaolins, argiles et oxydes colorants naturels: ces matières premières, cuites à des températures supérieures à 1200°C, constituent un grès pleine masse d'une **dureté exceptionnelle**, aux **caractéristiques mécaniques incomparables**.

PRODUCT FEATURES

- This material is **non-absorbent**: it is therefore easier to clean than alternative materials, and does not emit or absorb odours.
- It is **non-combustible** and **does not generate toxic substances** at any temperature.
- It is **resistant** to various atmospheric agents: not only is it frost-proof, but at the same time, being made from inorganic materials, the colour is not affected by UV rays.
- It is **recyclable**: 100% of raw waste is re-used to produce the collections in a percentage between 10% and 60%. The fired waste can be used as inert material for building.
- It has **high resistance to scratches and wear**, more so than any other covering material.

A SAFE PRODUCT

- The ideal product for under-floor heating, as it conducts heat and is not insulating. Moreover it does not emit harmful substances at any temperature.
- It does not emit Radon.
- It does not emit lead.
- It does not emit VOCs.
- It does not contain formaldehyde or asbestos.
- It is inhospitable to dust, bacteria and allergens.

[ES]

El gres porcelánico Mirage® es un **material compacto y resistente**. Las losas se obtienen a través de un proceso de gresificación, es decir la fusión completa en un solo material de arenas, cuarzos, feldespatos, caolines, arcillas y óxidos colorantes naturales: son materias primas que, cocidas a temperaturas superiores a 1200°C, forman un producto a toda masa de **excepcional durezza**, con **características mecánicas inigualables**.

[RU]

Керамический гранит Mirage® – это **плотный и прочный материал**. Плиты изготавливаются посредством процесса спекания, то есть полного слияния в единый материал песка, кварца, полевого шпата, каолина, глины и натуральных красящих окислов: сырьевые компоненты подвергающиеся обжигу при температуре, превышающей 1200°C, создают однородный продукт, обладающий **исключительной твердостью и несравними техническими характеристиками**.

[中國]

Mirage® 炻瓷磚是一種**致密而耐用的材料**。這些板材通過玻化過程而獲得，即沙子、石英、長石、高嶺土、粘土和天然色素氧化物完全融合而成的單一材料：原材料在1200°C以上的溫度下燒制，形成**超高硬度的**通體磚，具有**無與倫比的機械特性**。

TILES IN OUR OWN WAY

why would you choose **MIRAGE® PORCELAIN STONEWARE?**



MIRAGE SUSTAINABILITY STRATEGY



Mirage è, prima di tutto, le persone che ne fanno parte. Negli ultimi tre anni il numero dei nostri dipendenti è cresciuto del 13,3%: questo significa prendersi cura ogni giorno di qualcuno in più.

Per farlo, assicuriamo a chi fa parte di Mirage un ambiente di lavoro inclusivo e familiare. Ma siamo anche consapevoli del ruolo che le imprese come la nostra occupano all'interno della società, dove in un contesto in continua evoluzione, diventa fondamentale la capacità di adattarsi e di innovare, ma soprattutto la capacità di riuscire a farlo in modo sostenibile.

[EN]

Mirage's most valuable asset is its **people**. Over the past three years, the number of our employees and collaborators has increased. This means taking care of someone new every day. To do this, we make every effort to create an **inclusive and welcoming atmosphere for the entire Mirage workforce**. However, we also recognise the role that companies like ours play in society, where it is critical to be adaptive, innovative and, most importantly, sustainable in an ever-changing environment.

[FR]

Mirage vit, avant tout, grâce aux **personnes** qui en font partie. Lors de ces trois dernières années, le nombre de nos employés et de nos collaborateurs a augmenté : cela signifie prendre soin, chaque jour, d'une personne supplémentaire. Pour ce faire, nous garantissons à ceux qui font partie de Mirage un **espace de travail inclusif et familial**. Nous sommes également conscients du rôle que les entreprises telles que la nôtre occupent au sein de la société, où dans un contexte en évolution continue, la capacité de s'adapter et d'innover devient fondamentale, mais que la capacité de parvenir à le faire de manière durable l'est encore plus.

[RU]

Компания Mirage – это прежде всего люди, которые являются ее частью. За последние три года число работников и сотрудников выросло: а это значит ежедневная забота о ком-то еще. Для этого каждому, кто является частью компании, мы обеспечиваем **инклюзивную и семейную рабочую обстановку**. Но мы также осознаем и ту роль, которую такие предприятия, как наше, играют внутри общества, где в постоянно изменяющемся контексте становится очень важной способность адаптироваться и обновляться, но в особенности, это способность действовать в соответствии с концепцией устойчивого развития.

[DE]

Mirage sind in erster Linie die **Menschen**, die zum Unternehmen gehören. In den letzten drei Jahren ist die Anzahl unserer Arbeitnehmer und Mitarbeiter gestiegen: Das bedeutet, jeden Tag für jemanden mehr Sorge zu tragen. Hierzu versichern wir den Mitarbeitern von Mirage ein **integratives und familiäres Arbeitsumfeld**. Wir sind uns aber auch der Rolle bewusst, die Unternehmen wie unseres in der Gesellschaft einnehmen. In einem ständig wandelnden Kontext wird die Fähigkeit, sich anpassen und erneuern zu wissen, aber vor allem die Fähigkeit, dies auf nachhaltige Weise zu tun, wesentlich.

[ES]

Mirage es, antes que nada, su **gente**. En los últimos tres años ha aumentado la plantilla de personal y el número de colaboradores: esto significa tener cada día la responsabilidad de alguien más. Por eso, aseguramos a quienes forman parte de Mirage un **entorno de trabajo inclusivo y familiar**. Pero también somos conscientes del papel que las empresas como la nuestra desempeñan en la sociedad. En este entorno en constante evolución, es crucial la capacidad de adaptación e innovación, pero es sobre todo esencial la capacidad de hacerlo de forma sostenible.

[中國]

Mirage 首先代表公司的工作人员。在过去的三年里，我们的员工和合作者的数量有所增加：这意味着每天要照顾更多的人。为此，我们确保那些成为公司员工享有一个友好的工作环境。但我们也意识到像我们这样的公司在社会中所扮演的角色：在不断变化的环境中，适应和创新的能力变得至关重要，但最重要的是能够以可持续的方式做到这一点。

Per questo ci siamo dotati di un **Sistema di Gestione Ambientale** che ci consente di monitorare costantemente il nostro impatto ambientale e di migliorare le nostre performance.



ACQUA

Riutilizziamo il **100%** delle acque di processo.

Analizziamo con cadenza regolare i nostri consumi, e per diminuire ulteriormente l'acqua prelevata dall'acquedotto abbiamo creato un bacino artificiale in cui raccogliamo l'acqua piovana.

Entro il 2025, tale bacino artificiale ci permetterà di raggiungere l'autosufficienza idrica.

SCARTI

Reimpieghiamo il **100%** dello scarto crudo proveniente dalla produzione. Riutilizziamo il **100%** del nostro scarto cotto e una parte di quello che proviene da altre aziende.

Per massimizzare il recupero degli scarti la gestione dei rifiuti industriali è integrata nelle attività del Sistema di Gestione Ambientale.



EFFICIENZA ENERGETICA

Adottiamo le tecnologie più efficienti per ridurre il nostro consumo energetico, contribuendo a limitare l'emissione di CO₂ nell'atmosfera.

Abbiamo installato due impianti di cogenerazione, che ci consentono di sfruttare l'energia termica naturalmente generata. Per poter recuperare anche il calore proveniente dai forni, abbiamo investito nelle tecnologie più avanzate del settore.

Nel complesso, le tonnellate di CO₂ che ogni anno risparmiamo sono ben oltre **17.000**, pari all'emissione annuale di CO₂ di circa 3.173 individui.

Entro il 2025 concluderemo il progetto di un nuovo polo logistico dotato di un ulteriore impianto fotovoltaico e per il quale compenseremo interamente le emissioni di CO₂.

DURABILITÀ

Per Mirage, qualità è sinonimo di durabilità dei prodotti. E durabilità è sinonimo di consumo responsabile.

I nostri prodotti hanno una vita superiore ai **60 anni**. Una volta dismesso, il gres porcellanato Mirage è comunque **riciclabile al 100%**.



[EN]

This is why we have implemented an Environmental Management System that allows us to constantly monitor our environmental impact and improve our performance.

Water

We re-use **100%** of our process waters. We analyse our consumption at regular intervals, and to cut the amount of water taken from the aqueduct even further, we have created an artificial basin in which we collect rainwater. By 2025, this artificial basin will allow us to achieve water self-sufficiency.

Waste

We re-use **100%** of raw waste from the production process. We re-use **100%** of our own fired waste and part of fired waste from other companies. To maximise waste recovery, industrial waste management is integrated into the Environmental Management System.

Energy efficiency

We adopt the most efficient technologies to reduce our energy consumption, helping to limit the emission of CO₂ into the atmosphere. We have installed two cogeneration plants that allow us to utilise naturally produced thermal energy. We have also invested in the most advanced technology in the industry to recover heat from furnaces. We save a total of over **17,000 tonnes** of CO₂ a year, equal to the CO₂ emissions per year of around 3173 people. Our new logistics centre is expected to be completed by 2025, and will be equipped with a photovoltaic system to completely offset CO₂ emissions.

Durability

For Mirage, quality is synonymous with product durability, which in turn is synonymous with responsible consumption. Our products last for more than **60 years**, and at the end of its useful life, Mirage porcelain stoneware is **100% recyclable**.

OUR CERTIFICATIONS

ENVIRONMENT
requires ACTION

Le valutazioni di enti esterni sono per noi uno strumento di miglioramento; per i clienti rappresentano la garanzia del nostro impegno.

[EN]

We see assessments by external bodies as an opportunity for improvement, and for our customers, they offer a guarantee of our commitment.

ecovadis

ECOVADIS

Dal 2020 facciamo parte del network Ecovadis. Ecovadis analizza la strategia ESG (Environmental, Social and Governance) di migliaia di aziende al fine di aiutarle a migliorare le proprie performance in materia di sostenibilità.

Negli ultimi anni Mirage ha incrementato di diversi punti la propria scorecard. I punti di forza di Mirage, evidenziati dai certificatori della piattaforma, sono rappresentati dall'attenzione all'ambiente e ai diritti umani dei propri collaboratori.

We have been part of the Ecovadis network since 2020. Ecovadis analyses the ESG (Environmental, Social and Governance) strategy of thousands of companies, to help them improve their performance in terms of sustainability.

In recent years, Mirage has raised its scorecard by several points. Mirage's strengths, as highlighted by the platform's certifiers, are the attention it devotes to the environment and the human rights of its workers.

Declare.

DECLARE

L'etichetta Declare comunica al progettista, alle imprese e al consumatore finale da dove viene un prodotto, com'è composto e come può essere smaltito a fine ciclo di vita.

Mirage ha deciso di dotare i propri prodotti dell'etichetta Declare, per offrire ai propri clienti uno strumento di trasparenza garantita. Infatti, l'etichetta Declare viene rilasciata dall'International Living Future Institute (ILFI), un'organizzazione no profit impegnata nella diffusione di pratiche di sostenibilità nel settore dell'edilizia.

Declare è la carta d'identità delle nostre lastre. Qui sono indicati i componenti dei nostri prodotti, la totale assenza di sostanze pericolose, la loro durata e completa riciclabilità.

The Declare label informs project engineers, companies and the end consumer where a product comes from, what it is composed of and how it can be disposed of at the end of its life cycle.

Mirage has decided to adopt the Declare label for its products, as a guarantee of transparency for our customers. The label is issued by the International Living Future Institute (ILFI), a non-profit organisation committed to extending the use of sustainable practices in the construction sector.

Declare is the ID card of our tiles, indicating their components, the complete absence of hazardous substances, their duration and the fact they are fully recyclable.

EPD®

ENVIRONMENTAL PRODUCT DECLARATIONS

La EPD (Environmental Product Declaration) è una dichiarazione ambientale di prodotto, volontaria e certificata da terzi, che consente di conoscere l'impatto ambientale di ciascuna delle fasi di vita di un prodotto.

Mirage analizza l'impatto ambientale delle proprie lastre attraverso un'analisi di tutte le fasi del loro ciclo di vita: dall'estrazione delle materie prime fino al riuso, riciclo o smaltimento delle lastre.

The EPD (Environmental Product Declaration) is a voluntary instrument, certified by third parties, which indicates the environmental impact of each of the stages in a product's life cycle.

Mirage analyses the environmental impact of its tiles, considering all the phases in their life cycle: from the quarrying of the raw materials through to the re-use, recycling or disposal of the tiles.



ISO 14001

Mirage dispone della certificazione ISO 14001, che attesta l'avvenuta definizione di una politica ambientale da parte dell'azienda, la predisposizione di obiettivi misurabili per ridurre gli impatti ambientali dell'organizzazione e l'implementazione di appositi programmi per raggiungerli.

Mirage has ISO 14001 certification, attesting to the drafting of an environmental policy on the part of the company, the establishment of measurable objectives to reduce the organisation's environmental impact and the implementation of dedicated programmes to achieve those objectives.



ISO 17889-1

Mirage è stata la prima azienda del settore a dotarsi della certificazione ISO 17889-1, che riguarda specificatamente i prodotti ceramici.

Ispirata ai Sustainable Development Goals delle Nazioni Unite, la certificazione ISO 17889-1 prevede 38 indicatori di sostenibilità ambientale, sociale ed economica e rappresenta per l'azienda un ulteriore riconoscimento degli sforzi fin qui messi in campo.

Mirage was the first company in the sector to obtain ISO 17889-1 certification, which specifically regards ceramic products.

Inspired by the UN's Sustainable Development Goals, ISO 17889-1 certification establishes 38 environmental, social and economic sustainability indicators. For the company, it offers a further acknowledgement of the efforts made so far.



ISO 45001
Mirage ritiene la salute e la sicurezza dei propri collaboratori un'assoluta priorità.

Per questo motivo disponiamo della certificazione ISO 45001 che prevede la definizione di un sistema di gestione dei rischi riguardanti i lavoratori e il loro costante coinvolgimento, in un'ottica di miglioramento continuo.

Mirage considers the health and safety of its workers the company's top priority.

This is why we have adopted ISO 45001 certification, which establishes a system for the management of risks regarding workers, and for their constant involvement, with a view to on-going improvement.

PEF

PRODUCT ENVIRONMENTAL FOOTPRINT

La PEF (Product Environmental Footprint) è uno studio di impatto ambientale che indica le prestazioni di un prodotto nel corso del suo ciclo di vita.

The PEF (Product Environmental Footprint) is an environmental impact study that indicates the performance of a product during its life cycle.



LEED COMPLIANT

La certificazione LEED, che valuta le prestazioni degli edifici in termini di sostenibilità, prevede che i materiali di costruzione degli edifici LEED certified risultino conformi a requisiti di sostenibilità sociale ed ambientale.

Tutte le lastre Mirage sono LEED compliant e contribuiscono, in diversa misura, ad ottenere crediti LEED. In questo modo Mirage sceglie di collaborare, al fianco dei costruttori, allo sviluppo di edifici e di città resilienti e sostenibili.

LEED certification, which assesses the performance of buildings in terms of sustainability, establishes that all the construction materials used for LEED buildings must comply with a series of social and environmental sustainability requisites.

All Mirage tiles are LEED compliant, and contribute, to a varying extent, to the obtaining of LEED credits. Mirage has chosen to work alongside constructors on the development of resilient, sustainable buildings and cities.



WELL CERTIFICATION

La certificazione WELL, promossa dall'International WELL Building Institute, ha l'obiettivo di certificare i progetti edilizi volti a migliorare la qualità della vita di coloro che ne usufruiranno.

Le lastre Mirage assicurano ai progettisti materiali conformi agli standard WELL che includono caratteristiche che vanno dall'assenza di emissioni di sostanze pericolose al contrasto della proliferazione di muffe e batteri.

WELL certification, promoted by the International WELL Building Institute, seeks to certify building projects with a view to improving the quality of life of the people who will be living in those buildings.

Mirage tiles guarantee project engineers materials compliant with WELL standards, with characteristics including the absence of hazardous emissions and the ability to combat the spread of mould and bacteria.



ISO 9001
La ISO 9001 certifica, all'interno dell'azienda, l'esistenza di un sistema di gestione della qualità efficiente. Obiettivo centrale della certificazione volontaria è assicurare la soddisfazione del cliente.

È anche grazie ad un sistema di gestione della qualità che Mirage garantisce ai propri interlocutori un'attenzione particolare e individualizzata.

ISO 9001 certifies the existence of an efficient quality management system in the company. The key aim of this voluntary certification is to ensure customer satisfaction.

Our quality management system allows Mirage to guarantee close, personalised attention to everyone we engage with.

FDES

FICHE DE DÉCLARATION ENVIRONNEMENTALE ET SANITAIRE

La FDES (Fiche de Déclaration Environnementale et Sanitaire) presenta i risultati di un'analisi del ciclo di vita di un prodotto per l'edilizia.

In aggiunta, fornisce informazioni circa le sostanze contenute all'interno di un prodotto e la sua salubrità.

The FDES (Fiche de Déclaration Environnementale et Sanitaire) presents the outcomes of a life cycle analysis of a product for the building industry.

In addition, it provides information on the substances contained in a product, and how healthy it is



GREENGUARD

A testimonianza dell'impegno dell'azienda nella promozione di ambienti sempre più salubri, ed in particolare di un miglioramento della qualità dell'aria degli ambienti, Mirage dispone della certificazione Greenguard, che attesta bassi livelli di cessione di VOC (Volatile Organic Compounds).

In particolare, Mirage ha ottenuto lo score GOLD, dimostrando il miglior livello prestazionale secondo gli standards Greenguard.

Testifying to the company's commitment to promoting increasingly healthy environments, and in particular to improving air quality, Mirage has obtained Greenguard certification, attesting to low levels of VOC (Volatile Organic Compounds).

Mirage has obtained the GOLD score, indicating the top level of performance according to the Greenguard standards.



6mm 600x1200



**LIGHTER, LEANER,
GREENER**
The future
of porcelain tiles

Nuovo formato 600x1200 in 6 mm di spessore: una scelta sicura e sostenibile.

La caratteristica distintiva di questo formato è la sua leggerezza, che lo rende estremamente performante in una vasta gamma di applicazioni. Lo spessore sottile, infatti, agevola non solo il trasporto e la manipolazione delle lastre durante l'installazione, ma ne favorisce anche la lavorazione, compreso il taglio e la foratura; inoltre necessita un minor consumo di energia, materie prime e acqua in fase di produzione. Grazie al suo peso contenuto, è possibile trasportare più metri quadrati con un impatto ambientale minore.



[EN]
New **600x1200** format in **6 mm** thickness: **a safe and sustainable choice.**
The distinguishing feature of this format is its lightness, which makes it exceptionally effective in a wide range of applications. In fact, the thin profile not only facilitates the transportation and handling of the slabs during installation but also enhances processing efficiency, particularly in cutting and drilling operations. Additionally, because it's lighter, it uses less energy, fewer raw materials and requires less water during production. The low weight makes it possible to transport more square metres, resulting in a lower environmental impact.

[DE]
Neues Format **600x1200** in **6 mm** Stärke: **eine sichere, nachhaltige Entscheidung.**
Die Besonderheit dieses Formats ist seine Leichtigkeit, dank der es in einer breiten Palette von Anwendungen extrem gute Leistungen zeigt. So erleichtert die geringe Stärke nicht nur den Transport und die Handhabung der Platten während des Verlegens, sondern kommt auch der Bearbeitung zugute, so etwa auch dem Schneiden und Bohren; außerdem erfordert es in der Produktionsphase einen geringeren Energie-, Rohstoff- und Wasserverbrauch. Dank seines geringen Gewichts können mehr Quadratmeter mit geringeren Auswirkungen auf die Umwelt transportiert werden.

[FR]
Nouveau format **600x1200** de **6 mm** d'épaisseur : **un choix sûr et durable.**
La caractéristique distinctive de ce format est sa légèreté, qui le rend extrêmement performant dans une vaste gamme d'applications. En effet, sa fine épaisseur facilite non seulement le transport et la manipulation des plaques durant l'installation, mais en favorise aussi l'usinage, y compris la coupe et le perçage. En outre, ce format requiert une consommation réduite d'énergie, de matières premières et d'eau en phase de production. Grâce à son poids limité, il est possible de transporter plus de mètres carrés avec un impact environnemental moindre.

[ES]
Nuevo formato **600x1200** con espesor de **6 mm**: **una elección segura y sostenible.**
Este formato se distingue por su ligereza, una característica que lo hace muy adecuado para una amplia gama de aplicaciones. El espesor fino no solo facilita el transporte y la manipulación de las placas durante la instalación, sino también su mecanizado, incluidos el corte y la perforación; además, requiere menos consumo de energía, materias primas y agua durante la producción. Por su peso bajo, se pueden transportar más metros cuadrados con un menor impacto ambiental.

[RU]
Новый формат **600x1200** толщиной **6 мм**: **устойчивый и надежный выбор.**
Отличительной характеристикой этого формата является легкость, что делает его идеально подходящим для самых разнообразных применений. Малая толщина, действительно, облегчает не только транспортировку и перемещение плит во время установки, но и упрощает обработку, включая резку и сверление; а, кроме того, на этапе производства требуется меньший расход электроэнергии, сырья и воды. Благодаря умеренному весу можно перевозить большее количество квадратных метров плит с меньшим воздействием на окружающую среду.

[中國]
全新 **600x1200** 规格, 厚度为 **6 毫米**: **安全且可持续的选择。**
这种幅面的显著特点是重量轻, 因此在广泛的应用中性能极佳。较薄的厚度不仅便于运输和安装过程中板材的处理, 而且还有助于加工, 包括切割和钻孔; 生产过程中还需要消耗较少的能源、原材料和水。由于其重量轻, 可以运输更多平方米, 同时减少对环境的影响。

Da oltre 20 anni la Divisione Engineering Mirage® accompagna gli operatori ed i professionisti del settore in tutte le fasi del lavoro.

 **Maggiori informazioni**
More information



Un supporto tecnico altamente qualificato e strutturato, che fornisce consulenza a 360° per la progettazione e la realizzazione di sistemi e soluzioni ingegnerizzate per pavimenti e rivestimenti.

Una gamma di servizi completi, che spaziano dallo studio di fattibilità, alla progettazione e pianificazione sino alla posa in opera di facciate ventilate e pavimenti sopraelevati per l'indoor e l'outdoor.



Monti Headquarter - Italy

[EN]

For more than 20 years, the Mirage® Engineering Division has been assisting and supporting operators and professionals throughout all phases of the work.

A highly qualified and well-organised technical office provides comprehensive support services for the design and creation of reliable floor and wall systems and solutions.

A complete range of services are offered, ranging from feasibility studies, design and planning to the installation of ventilated facades and raised floors for indoor and outdoor use.

[DE]

Seit mehr als 20 Jahren unterstützt die Engineering-Abteilung von Mirage® Marktteilnehmer und Fachleute in allen Arbeitsphasen.

Ein hochqualifizierter und strukturierter technischer Support, der eine 360°-Beratung für die Planung und Umsetzung zuverlässiger Systeme und Lösungen für Boden- und Wandbeläge bietet.

Ein komplettes Leistungsspektrum, das von Machbarkeitsstudien, Design und Planung bis hin zur Installation von hinterlüfteten Fassaden und Doppelböden für den Innen- und Außenbereich reicht.

[FR]

Depuis plus de 20 ans, la Division Engineering Mirage® accompagne les opérateurs et les professionnels du secteur dans toutes les phases de leur travail.

Un support technique hautement qualifié et structuré, qui fournit des conseils complets pour la conception et la réalisation de systèmes et de solutions fiables pour les revêtements de sols et muraux.

Une gamme de services complète, qui va de l'étude de faisabilité à la pose de façades ventilées et de planchers surélevés pour l'intérieur et l'extérieur, en passant par la conception et la planification.

[ES]

Desde hace más de 20 años la División Engineering Mirage® acompaña a operadores y profesionales del sector en todas las etapas del trabajo.

Un soporte técnico experto y estructurado que proporciona consultoría de 360° para el proyecto e implementación de sistemas y soluciones fiables para pavimentos y revestimientos.

Una completa gama de servicios que abarcan desde el estudio de viabilidad al proyecto y la planificación, la colocación de fachadas ventiladas y pavimentos elevados para uso en interiores y exteriores.

[RU]

Уже более 20 лет Подразделение инжиниринга компании Mirage® оказывает поддержку трейдерам и специалистам этого сектора на всех этапах работы.

Высококвалифицированная и структурированная поддержка гарантирует всеобъемлющую консультацию по проектированию и созданию надежных систем и решений для облицовки полов и стен.

Полный ассортимент услуг, от разработки технико-экономического обоснования до проектировки и планирования, вплоть до укладки плит вентилируемых фасадов и напольных покрытий на приподнятой конструкции для внутренних и наружных работ.

[中國]

20多年来, Mirage®工程部门在工作的所有阶段为操作人员 and 行业专业人员提供支持。高素质和高度结构化的技术支持, 为设计和实施可靠的地砖和墙砖系统和解决方案提供 360度的咨询服务。提供从可行性研究到设计和规划, 直到室内/室外通风幕墙和木地板施工的全方位服务。

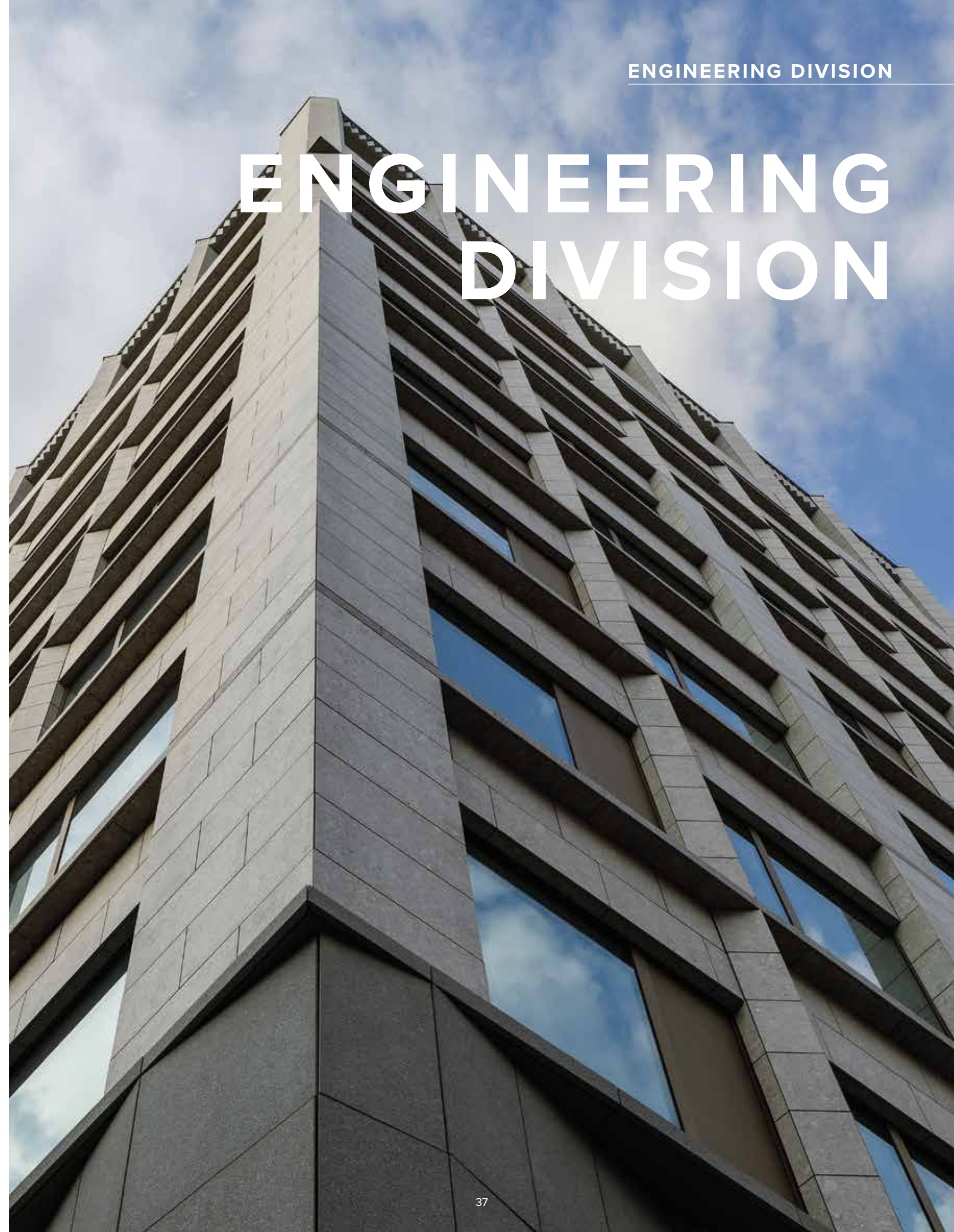

MEFIS

EXTERIOR FIXING AND INSULATION SYSTEM

MEFIS è il sistema che Mirage Engineering propone per l'isolamento di facciate e rivestimenti esterni, composto da lastre grès porcellanato ancorate a pannelli in EPS.

Semplicità, efficacia ed estetica fanno di MEFIS una soluzione rivoluzionaria e pronta all'uso a disposizione del mondo dell'architettura e dell'edilizia.

VANTAGGI TECNICI

- ISOLAMENTO TERMICO
- ISOLAMENTO ACUSTICO
- SICUREZZA
- RESISTENZA AGLI URTI
- SEMPLICITÀ DI POSA
- RAPIDITÀ DI POSA
- ZERO MANUTENZIONE

TECHNICAL ADVANTAGES

- THERMAL INSULATION
- ACOUSTIC INSULATION
- SAFETY
- SHOCK RESISTANCE
- SIMPLE INSTALLATION
- QUICK INSTALLATION
- ZERO MAINTENANCE

1 Gres porcellanato Mirage®
Mirage® porcelain stoneware

2 Pannello isolante in EPS
EPS insulating panel

3 Ganci stabilizzanti
Stabilising hooks

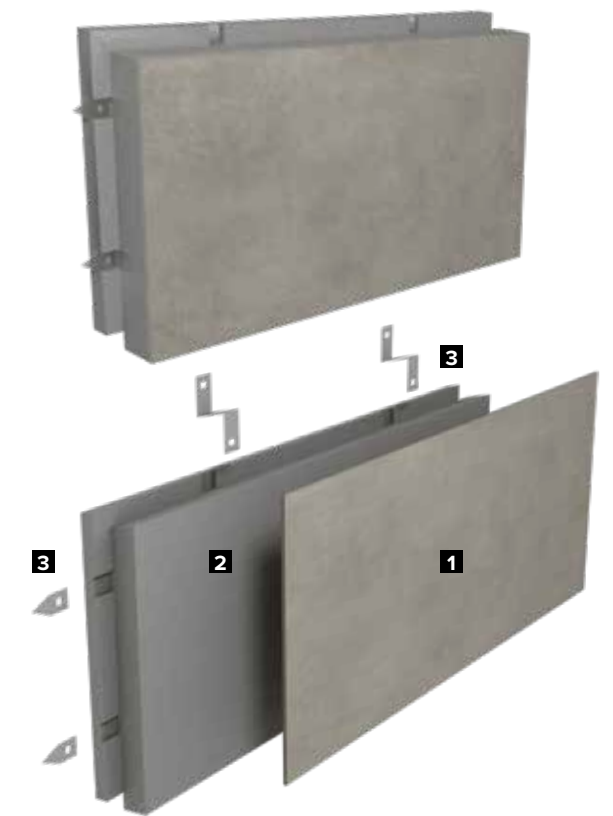

[EN] MEFIS, developed by Mirage Engineering, is a revolutionary system for **insulating exterior walls and surfaces**. It consists of **porcelain stoneware slabs that are anchored to EPS panels**. MEFIS is an easy-to-use, effective and visually pleasing solution for the world of architecture and construction.

[FR] MEFIS est le système que Mirage Engineering propose pour l'isolation de **façades et de revêtements extérieurs**, composé de **plaques en grès cérame ancrées à des panneaux en EPS**. Simplicité, efficacité et esthétique font de MEFIS une solution révolutionnaire et prête à l'emploi à disposition du monde de l'architecture et du bâtiment.

[DE] MEFIS ist ein aus an **EPS-Platten verankerten Feinsteinzeugplatten** bestehendes System, das Mirage Engineering für die **Dämmung von Fassaden und Außenverkleidungen** anbietet. Einfachheit, Effizienz und Ästhetik machen MEFIS zu einer revolutionären, gebrauchsfertigen Lösung, die der Welt der Architektur und des Bauwesens zur Verfügung gestellt wird.

[ES] MEFIS es el sistema que Mirage Engineering propone para el **aislamiento de fachadas y revestimientos exteriores**, formado por **placas de gres porcelánico fijadas a paneles de EPS**. Por su sencillez, eficacia y estética, MEFIS es una solución revolucionaria y lista para el uso a disposición del mundo de la arquitectura y de la construcción.

[RU] MEFIS – это система, предлагаемая подразделением Mirage Engineering для **теплоизоляции фасадов и наружной обшивки**, состоящие из плит из **керамогранита, прикрепленных к панелям из полистирола**. Простота, эффективность и эстетика делают систему MEFIS революционным решением, готовым для применения и пригодным для архитекторов и строителей.

[中國] MEFIS 是 Mirage Engineering (Mirage 工程公司) 提出的用于外墙和外包层保温的系统, 由固定在 EPS 板上的瓷质石板组成。简洁、有效和美观使 MEFIS 成为建筑和施工领域可用的革命性的、随时可用的解决方案。

 **Maggiori informazioni**
More informations



evo_2/e™ OUTDOOR SYSTEM

it's TIME to
GO OUT!

EVO_2/E™ di Mirage® è il primo grès porcellanato in 20 e 30 mm di spessore prodotto e commercializzato come progetto completo per l'universo outdoor.

 **Maggiori informazioni**
More informations



Un sistema completo di pavimenti e pezzi speciali per spazi esterni pubblici e residenziali, capace di coniugare prestazioni tecniche di altissimo livello ad un ricercato gusto estetico.

Una concezione ceramica innovativa che risponde ad ogni esigenza grazie ad una vasta gamma di formati, colori, finiture e differenti modalità di posa.



[EN]
EVO_2/E™ by Mirage® is the first **20 and 30 mm thick porcelain stoneware** produced and sold as a complete outdoor project.
A complete system of floors and special pieces for public and residential outdoor spaces, with high technical and visual performance.
An innovative ceramic concept that offers a **wide range of different sizes, colours, finishes and installation methods.**

[DE]
EVO_2/E™ by Mirage® ist das erste **Feinsteinzeug mit 20 und 30 mm Stärke**, das als Gesamtprojekt für die Gestaltung von Außenbereichen produziert und vermarktet wird.
Ein komplettes System von Fußböden und Formteilen für den öffentlichen und privaten Außenbereich, das in der Lage ist, höchste technische Leistung mit einem raffinierten ästhetischen Geschmack zu verbinden.
Ein innovatives Keramikkonzept, das dank einer **großen Auswahl an Größen, Farben, Oberflächen und Verlegemethoden keine Wünsche offenlässt.**

[FR]
EVO_2/E™ de Mirage® est le premier **20 et 30 mm en grès cérame** produit et commercialisé pour toutes les applications extérieures.
Un système complet de revêtements de sol et de pièces spéciales pour les espaces extérieurs publics et résidentiels, concentré unique de performances techniques de haut niveau et d'esthétique recherchée.
Une nouvelle conception de la céramique, qui propose une **vaste gamme de formats, de couleurs, de finitions et de modalités de pose.**

[ES]
EVO_2/E™ de Mirage® es el primer **gres porcelánico de 20 y 30 mm de espesor** que se produce y comercializa como proyecto completo para el universo outdoor.
Un sistema completo de pavimentos y piezas especiales para espacios públicos y residenciales al aire libre, que combina un alto desempeño técnico con un sofisticado gusto estético.
Una innovadora concepción cerámica que satisface cada necesidad gracias a una **amplia línea de formatos, colores, acabados y diferentes métodos de colocación.**

[RU]
EVO_2/E™ производства компании Mirage® - это первый **керамогранит толщиной 20-30 мм**, выпускаемый и продаваемый, как комплексный проект для наружных работ.
Комплексная система плит для настилов и специальных элементов для отделки общественных и жилых площадей, сочетающая технические характеристики высочайшего уровня с изысканным эстетическим вкусом.
Инновационное решение керамической плитки, способное удовлетворить любое требование благодаря **широкому ассортименту форматов, цветов, отделки и различным способам укладки.**

[中國]
Mirage®的EVO_2/E™是作为户外环境的完整系列而生产和销售的第一个**20-30毫米厚的炻瓷砖**产品系列。
这个用于公共和住宅户外空间的**完整地砖和特殊件系列**,能够将高水平的技术性能和高雅的审美品味完美结合。创新的陶瓷理念,可以满足各种尺寸、颜色、饰面 and 不同施工模式的要求。

Il progetto EVO_2/E™ Mirage® propone un set di soluzioni di posa adatte a ogni terreno e superficie per garantire la massima versatilità applicativa.



Private House - USA



Resort - France

MASSIMA VERSATILITÀ APPLICATIVA

- Posa su erba
- Posa su massetto
- Posa su ghiaia
- E-BASE
- E-DECK
- ROOFTOP E-DECK

FULL LAYING VERSATILITY

- Laying on grass
- Adhesive installation
- Laying on gravel
- E-BASE
- E-DECK
- ROOFTOP E-DECK

[EN] The Mirage® EVO_2/E™ project offers a number of installation solutions suitable for any type of terrain and surface to guarantee maximum laying versatility.

[FR] Le projet EVO_2/E™ Mirage® propose un ensemble de solutions de pose adaptées à chaque terrain et surface, afin de garantir la plus grande polyvalence d'application.

[DE] Das Projekt EVO_2/E™ Mirage® bietet eine Reihe von Verlegelösungen, die für jeden Untergrund und jede Oberfläche geeignet sind, um eine maximale Vielseitigkeit der Anwendung zu gewährleisten.

[ES] El proyecto EVO_2/E™ Mirage® ofrece un conjunto de soluciones de colocación adecuadas para todo terreno y superficie y asegura la máxima versatilidad de aplicación.

[RU] Проект EVO_2/E™ компании Mirage® предлагает набор решений по укладке плит, пригодных для любого типа грунта и поверхности, в целях обеспечения наибольшего разнообразия вариантов применения.

[中國] Mirage®的EVO_2/E™项目提出了一系列适合任何土地和表面的施工解决方案，以确保最大的多样化应用。

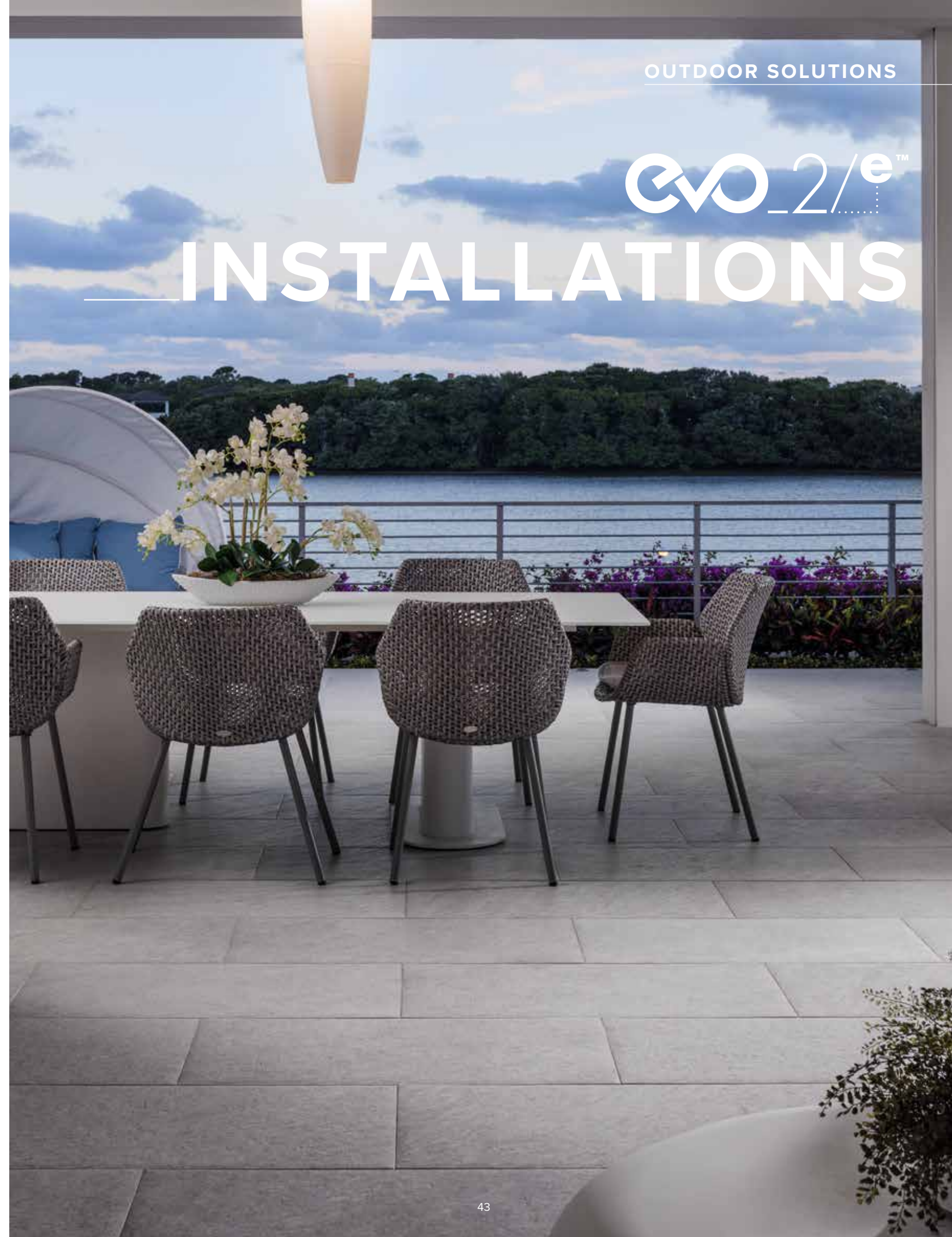

OUTDOOR SOLUTIONS

EVO_2/E™

INSTALLATIONS

EVO Living



EVO_Living è un progetto di tavoli per l'outdoor, che unisce le altissime prestazioni tecniche del gres porcellanato ad un design inconfondibilmente elegante e naturale.

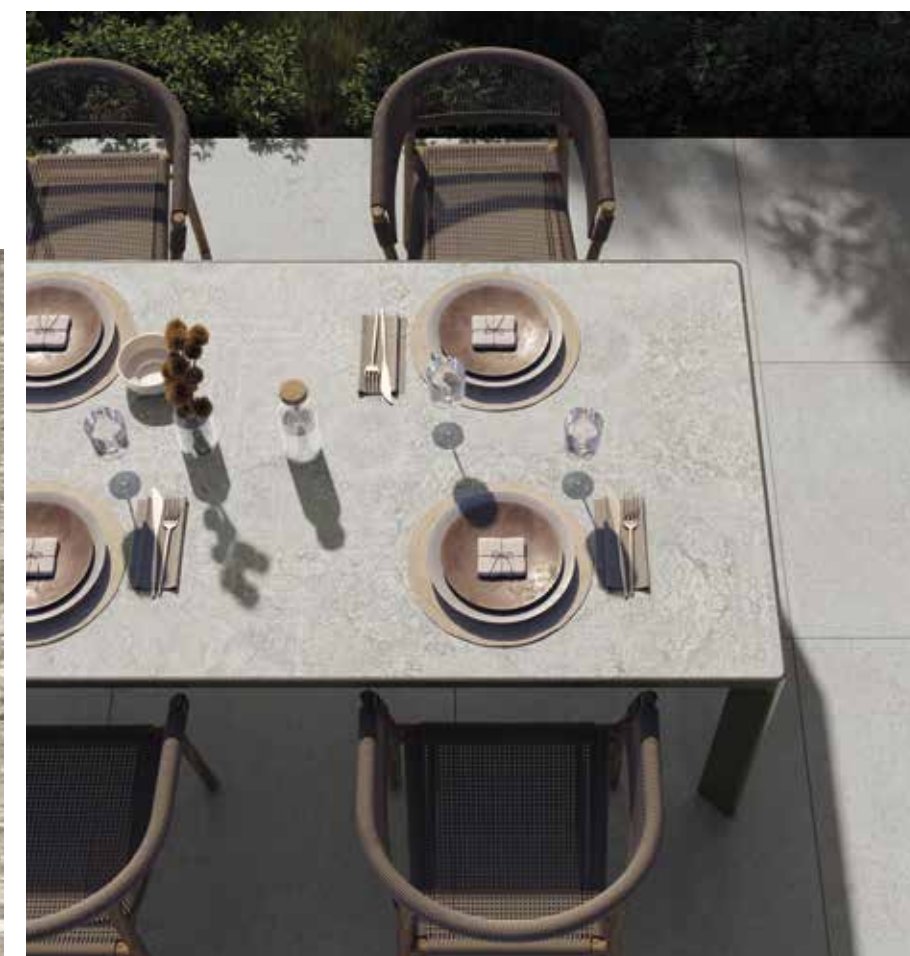

[EN]
EVO_Living is an outdoor table project that blends the ultra-high technical performance of porcelain stoneware with an unmistakably elegant and natural design.

[DE]
EVO_Living ist ein Tischprojekt für den Outdoorbereich, das die hohen technischen Leistungen von Feinsteinzeug mit einem unverkennbar eleganten und natürlichen Design vereint.

[FR]
EVO_Living est un projet de tables pour l'extérieur, qui allie les très hautes prestations techniques du grès cérame à un design incontestablement élégant et naturel.

[ES]
EVO_Living es un proyecto de mesa de exterior que combina las altas prestaciones técnicas del gres porcelánico con un diseño inconfundible, elegante y natural.

[RU]
EVO_Living – это проект, предлагающий столы, предназначенные для улицы, соединяющий в себе высокие технические характеристики керамогранита с легко узнаваемым элегантным и натуральным дизайном.

[中國]
EVO_Living 是一个专为户外设计的餐桌项目，它将陶瓷石器的高技术性能与优雅自然的设计完美结合。

 **Maggiori informazioni**
More informations



Con **EVO_Living**, **Mirage®** amplia la propria offerta per l'outdoor e il gardening con una collezione perfettamente integrata nel sistema **EVO_2/E™**.

Ideale per giardini, patii e terrazzi, per momenti di svago, convivialità e relax, sia in ambito residenziale che commerciale. Il progetto **EVO_Living** propone un'ampia gamma di Top in gres porcellanato: 8 lastre disponibili tra effetto pietra, cemento, legno e decorato, per soddisfare ogni esigenza estetica.

[EN]
With **EVO_Living**, **Mirage®** extends its outdoor and gardening range: a collection with an exclusive design, perfectly integrated into the **EVO_2/E™** system. Ideal for gardens, patios and terraces, for leisure occasions, conviviality and relaxation, in both residential and commercial settings. The **EVO_Living** project proposes a wide selection of porcelain stoneware countertops: eight slabs available in stone, cement, wood and decorated effects, to meet all aesthetic requirements.

[DE]
Mit **EVO_Living** erweitert **Mirage®** das eigene Angebot für den Outdoorbereich und die Gartengestaltung: eine Kollektion mit exklusivem Design, das perfekt in das System **EVO_2/E™** integriert ist. Ideal für Gärten, Höfe und Terrasse, für Augenblicke der Unterhaltung, Geselligkeit und Entspannung sowohl im Wohn- als auch im Gewerbebereich. Das Projekt **EVO_Living** bietet eine breite Palette von Feinsteinzeugplatten: 8 Platten in Stein-, Zement-, Holz- und Dekoreffekt, die allen ästhetischen Ansprüchen gerecht werden.

[FR]
Avec **EVO_Living**, **Mirage®** élargit son offre pour l'outdoor et le jardinage : une collection au design exclusif, parfaitement intégrée dans le système **EVO_2/E™**. Idéale pour les jardins, les patios et les terrasses, pour des moments de distraction, de convivialité et de détente, dans le domaine résidentiel comme commercial. Le projet **EVO_Living** propose une gamme étendue de plans en grès cérame : 8 plaques disponibles dans différents effets parmi lesquels l'effet pierre, ciment, bois et décoré, afin de satisfaire toutes les exigences esthétiques.

[ES]
Mirage® amplia con **EVO_Living** su oferta para exterior y jardín: una colección de diseño exclusivo, que se integra a la perfección en el sistema **EVO_2/E™**. Ideal para jardines, patios y terrazas, para el ocio, los momentos compartidos y el relax, tanto en entornos residenciales como comerciales. El proyecto **EVO_Living** ofrece una amplia gama de encimeras de gres porcelánico: 8 placas disponibles entre efectos piedra, cemento, madera y decorado, para satisfacer todas las exigencias estéticas.

[RU]
Благодаря проекту **EVO_Living** компания **Mirage®** смогла расширить свое предложение для улицы и сада коллекцией, прекрасно интегрированной в систему **EVO_2/E™**. Идеально подходящая для сада, патио, террас, для моментов досуга, застолья и отдыха, как в жилом, так и торговом секторе. Проект **EVO_Living** предлагает широкий ассортимент столешниц из керамогранита: 8 дизайнов плит с эффектом натурального камня, цемента, декорированного дерева для удовлетворения любой эстетической потребности.

[中國]
Mirage® 推出的 **EVO_Living** 系列产品与 **EVO_2/E™** 系统完美结合, 扩大了其户外和园艺产品的范围。是花园、庭院和露台、休闲、聚会和放松的理想选择、适合住宅和商业环境。**EVO_Living** 项目提供多种陶瓷石器台面: 8 块石板有石质、水泥、木质和装饰效果, 可满足各种审美需求。



SOUL
Soluzione con top in gres porcellanato **Mirage** ad incasso, per un design più lineare e minimalista

EDEN
Soluzione con top in gres porcellanato **Mirage** ad appoggio, per un aspetto più classico e versatile

Soul e Eden sono due tipologie di tavoli disponibili, entrambi contraddistinti da un'elevata funzionalità e da forme ergonomiche.

[EN]
The collection also includes two types of highly functional, meticulously crafted **TABLES** with ergonomic shapes. **SOUL**: solution with recessed **Mirage®** porcelain stoneware top, for a more linear, minimal design. **EDEN**: solution with surface-mounted **Mirage®** porcelain stoneware top, for a more classic and versatile appearance.

[DE]
2 Arten von **TISCHEN**, die sich beide durch hohe Funktionalität, Design bis ins kleinste Detail und ergonomische Formen auszeichnen. **SOUL**: Lösung mit Platte aus Feinsteinzeug von **Mirage®** in der Einbauversion, für ein lineares, minimalistischeres Design. **EDEN**: Lösung mit Platte aus Feinsteinzeug von **Mirage®** in der Aufsatzversion, für einen klassischeren, vielseitigen Look.

[FR]
2 sont les typologies de **TABLES**, toutes les deux caractérisées par une fonctionnalité élevée, un design soigné dans ses moindres détails et des formes ergonomiques. **SOUL**: solution avec plan de travail encastrable en grès cérame **Mirage®**, pour un design plus linéaire et minimaliste. **EDEN**: solution avec plan de travail en grès cérame **Mirage®** en appui, pour un aspect plus classique et polyvalent.

[ES]
2 tipologías de **MESAS**, ambas caracterizadas por una elevada funcionalidad, un diseño cuidado hasta en el más mínimo detalle y formas ergonómicas. **SOUL**: con tablero de gres porcelánico **Mirage®** empotrado, que propone un diseño más lineal y minimalista. **EDEN**: solución con tablero de gres porcelánico **Mirage®** apoyado, para un estilo más clásico y versátil.

[RU]
SOUL and EDEN – две предлагаемые модели столов, отличающиеся высокой функциональностью и эргономичностью форм.

[中國]
SOUL and EDEN 是两种可供选择的桌子, 它们都具有高度的功能性和符合人体工程学的形状。

Le grandi lastre si integrano perfettamente all'interno della gamma di collezioni Mirage®, aumentandone le potenzialità.

Una gamma che comprende oltre 60 colori, differenti superfici e ispirazioni materiche, sintesi di tecnologia e creatività.



All'interno di un panorama architettonico dinamico ed articolato, l'ampia offerta di grandi lastre Mirage® genera **nuove opportunità progettuali e funzionali**, garantite dalle dimensioni e dalle molteplici possibilità applicative.

[EN]

The large-size slabs integrate perfectly into the range of Mirage® collections, increasing the application possibilities.

A range including over 60 colours, different material inspirations and surfaces, the synthesis of technology and creativity.

Within a dynamic and well-defined architectural panorama, Mirage's wide range of large-size slabs opens up **new design and functional opportunities**, guaranteed by the sizes and the numerous application possibilities.

[DE]

Die großen Platten fügen sich perfekt in die Mirage®-Kollektion ein und erhöhen ihr Potenzial.

Eine Produktpalette, die mehr als 60 Farben und verschiedene Materialinspirationen und Oberflächen umfasst, in der die Technologie und die Kreativität perfekt miteinander verschmelzen.

Innerhalb einer dynamischen und aufgefächerten Architekturlandschaft, generiert die große Auswahl an großen Mirage®-Platten **neue Gestaltungsmöglichkeiten und funktionelle Optionen**, die durch die Größe und die vielfältigen Anwendungsmöglichkeiten garantiert werden.

[FR]

Les grandes plaques s'intègrent parfaitement à l'éventail de collections Mirage® et en augmentent les potentialités.

Une gamme qui comprend plus de 60 couleurs, différentes inspirations de matières et de surfaces, synthèse de technologie et de créativité.

Au sein d'un panorama architectural dynamique et structuré, la vaste gamme de grandes plaques Mirage® génère de **nouvelles opportunités fonctionnelles et de conception**, garanties par les dimensions et les multiples possibilités d'application.

[ES]

Las grandes placas se integran perfectamente en la línea de las colecciones Mirage®, mejorando su potencial.

Una gama que incluye más de 60 colores, diferentes inspiraciones materiales y acabados, síntesis de tecnología y creatividad.

Dentro de un panorama arquitectónico dinámico y articulado, la amplia oferta de grandes placas Mirage® genera **nuevas oportunidades de proyecto y funcionales**, garantizadas por su tamaño y las múltiples posibilidades de aplicación.

[RU]

Крупноформатные плиты прекрасно дополняют гамму коллекций Mirage®, увеличивая их потенциал. **Ассортимент включает более 60 цветовых вариантов, богатый выбор фактур и дизайнов**, являющихся результатом взаимодействия технологии и креативности.

В рамках динамичной и сложной архитектурной панорамы широкий ассортимент крупноформатных плит Mirage® создает **новые проектные и функциональные возможности** благодаря размерам и разнообразию применения продукта.

[中國]

大尺寸板材完美补充了Mirage®系列产品，增强了它的潜力。 **该系列包括60多种颜色，灵感源自各种不同的材料和表面**，是技术与创意的完美结合。

在一个动态和密切相关的建筑全貌中，Mirage®大尺寸板材系列的众多产品， **提供了新的设计和功能的机会**，其尺寸和多样化的应用保证了这一点。

 **Maggiori informazioni**
More informations



SLABS for DESIGN
and ARCHITECTURE

100%
SLABS

Perché le grandi lastre Mirage®:

- Minore numero di fughe, estetica impareggiabile e maggiore pulibilità.
- Continuità tra pavimento e rivestimento.
- Integrazione e coordinabilità tra formati grandi e formati classici.
- Fedeltà ed affidabilità delle forniture.
- Ampia gamma formati e colori.



Infinita possibilità progettuali

- Pavimenti
- Rivestimenti
- Facciate
- Banconi
- Lavabi
- Arredi
- Top bagno
- Piatti doccia
- Residenziale
- Commerciale
- Interni / Esterni



- [EN]
Why large Mirage® slabs:
- Greater aesthetic impact and easier to clean due to less grout joints.
 - Seamless transition between floor and walls.
 - Integration and mix-and-match of large sizes and classic sizes.
 - Efficient and reliable supply.
 - Wide range of sizes and colours.

- [DE]
Gründe für die Großformatigen Platten von Mirage®:
- Mehr Ästhetik und bessere Pflegeleichtigkeit durch weniger Fugen.
 - Kontinuität zwischen Boden- und Wandfliesen.
 - Integration und Koordination zwischen großen und klassischen Formaten.
 - Genauigkeit und Zuverlässigkeit bei den Lieferungen.
 - Große Auswahl an Größen und Farben.

- [FR]
Pourquoi les grandes plaques Mirage® :
- Esthétique sans compromis et meilleure nettoyabilité grâce au nombre réduit de joints.
 - Continuité entre sol et revêtement mural.
 - Intégration et combinaison entre grands formats et formats classiques.
 - Fidélité et fiabilité des fournitures.
 - Vaste gamme de formats et de couleurs.

- [ES]
Por qué las grandes placas Mirage®:
- Menor número de juntas, estética inigualable y mayor limpiabilidad.
 - Continuidad entre pavimento y revestimiento.
 - Integración y coordinabilidad de formatos grandes y clásicos.
 - Fidelidad y fiabilidad de los suministros.
 - Amplia gama de formatos y colores.

- [RU]
Почему крупноформатные плиты производства Mirage®:
- Меньшее количество швов, несравнимый эстетический эффект и проще очистка.
 - Цельность отделки стен и полов.
 - Дополнение и комбинирование плит крупного и традиционного форматов.
 - Верность и надежность поставок.
 - Широкий выбор форматов и цветовых вариантов.

- [中國]
为什么要使用Mirage®的大尺寸陶瓷板材:
- 由于填缝数量较少, 美观性和清洁性更高。
 - 地砖和墙砖之间的连续性。
 - 大尺寸和经典尺寸之间的集成和协调。
 - 供应产品的忠诚度和可靠性。
 - 多种尺寸和颜色。

- [EN]
Endless design possibilities
- Floorings
 - Coverings
 - Facades
 - Countertops
 - Washbasins
 - Furnitures
 - Vanity Top
 - Shower trays

- Residential Areas
- Commercial Areas
- Indoor / Outdoor Areas

- [DE]
Unendliche kreative Möglichkeiten
- Bodenbeläge
 - Wandverkleidungen
 - Fassaden
 - Theken
 - Waschbecken
 - Einrichtungsobjekte
 - Waschtischplatten
 - Duschwannen

- Residential
- Gewerbebereiche
- Innen- und Außenbereiche

- [FR]
Possibilités conceptuelles infinies
- Sols
 - Revêtements
 - Façades
 - Comptoirs
 - Lavabos
 - Décorations
 - Plan de salle de bains
 - Receveurs de douche

- Résidentiel
- Commercial
- Intérieurs / Extérieurs

- [ES]
Endless design possibilities
- Pavimentos
 - Revestimientos
 - Fachadas
 - Mostradores
 - Lavabos
 - Equipamientos
 - Vanity Top
 - Platos de ducha

- Residencial
- Comercial
- Interiores / Exteriores

- [RU]
Бесконечное множество проектных вариантов
- Напольное покрытие
 - Облицовка стен
 - Фасады
 - Торговые прилавки
 - Мойки
 - Предметы обстановки
 - Vanity Top
 - Душевые поддоны

- Жилой сектор
- Торговый сектор
- Интерьер / Экстерьер

- [中國]
无限的设计可能性
- 地板
 - 牆壁
 - 外立面
 - 柜台
 - 洗手台
 - 家具
 - 浴室工作台面
 - 淋浴房底盆

- 住宅
- 商业
- 内部/外部

Affidabilità + sicurezza + libertà progettuale

Ricerca ed eccellenza estetica sono solo il punto di partenza per le grandi lastre Mirage®.

Le nostre superfici, realizzate solo con le migliori materie prime e sinterizzate a oltre 1200° con tutto il know-how e l'ingegneria Mirage®, permettono di poter contare su un materiale ultra compatto, con performance tecniche senza compromessi e un impareggiabile livello di praticità e sicurezza.



[EN]

Reliability + safety + design freedom
Research and superb style are just the start of what Mirage large slabs have to offer. Our surfaces, created using only the finest materials and sintered at over 1200° with all the knowhow and engineering skill of Mirage, offer the guarantee of an ultra-compact material that boasts uncompromising technical performance and a peerless level of safety and practical qualities.

[DE]

Zuverlässigkeit + sicherheit + gestaltungsfreiheit
Forschung und Entwicklung und ästhetische Exzellenz sind nur der Ausgangspunkt für die großen Platten von Mirage. Unsere Oberflächen werden nur aus den besten Rohstoffen hergestellt und mit dem gesamten Know-how und der Technik von Mirage bei über 1200° C gesintert. Auf diese Weise entsteht ein ultrakompaktes Material mit kompromissloser technischer Leistung und einem beispiellosen Maß an Funktionalität und Sicherheit.

[FR]

Fiabilité + sécurité + liberté conceptuelle
La recherche et l'excellence esthétique constituent le seul point de départ pour les grandes plaques Mirage. Nos surfaces, réalisées uniquement à partir des meilleures matières premières et sinterisées à plus de 1200° grâce au savoir-faire et à l'ingénierie Mirage, permettent de pouvoir compter sur un matériau ultra compact, avec des performances techniques sans compromis et un niveau de praticité et de sécurité inégalable.

[ES]

Fiabilidad + seguridad + libertad de diseño
Investigación y excelencia estética son solo el punto de partida de las grandes placas Mirage®. Nuestras superficies, fabricadas solo con las mejores materias primas y sinterizadas a más de 1200° con todo el saber y la ingeniería Mirage®, permiten poder contar con un material ultracompacto, con unas prestaciones técnicas sin concesiones y un nivel de practicidad y seguridad sin igual.

[RU]

Надежность + безопасность + свобода проектирования
Научно-технические разработки и высокие эстетические характеристики – вот исходные отличительные черты плит крупного формата компании Mirage®. Наши плиты, изготовленные исключительно из высококачественного сырья с обжигом при температуре свыше 1200° с использованием всех научно-технических знаний и технологий Mirage®, позволяют рассчитывать на сверхкомпактный материал, с техническими свойствами без компромиссов и несравненным уровнем практичности и безопасности.

[中國]

可靠性+安全+设计自由
研究和出色美观只是Mirage大规模瓷砖板材的起点。我们的瓷砖仅使用最佳原材料制成，并且在超过1200° 的温度下使用 Mirage 专有技术和工程技术进行烧结，使我们能够制造超致密的材料，具有出色的技术性能和无与伦比的实用性和安全性。

VANTAGGI TECNICI TECHNICAL ADVANTAGES



Idonee al contatto con alimenti
Suitable for contact with foodstuffs
Geeignet für den Kontakt mit Lebensmitteln
Aptes au contact avec les aliments
Aptos para el contacto con alimentos
Подходит для контакта с едой
适合与食物接触



Inattaccabili da macchie e acidi
Impervious to stains and acids
Flecken- und säurebeständig
Inattaquables par les taches et les acides
Inatacables por las manchas y los ácidos
Устойчивы к воздействию пятен и кислот
不易受污渍和酸侵蚀



Resistenti al calore
Heat resistant
Hitzebeständig
Résistantes à la chaleur
Resistentes al calor
Устойчивы к воздействию тепла
耐热



Inassorbenti
Non-absorbent
Geringe Wasseraufnahme
Non absorbantes
Inabsorbentes
Не поглощают влагу
不吸水



Superfici resistenti e compatte
Resistant, compact surfaces
Robuste und kompakte Oberflächen
Surfaces résistantes et compactes
Resistentes y compactas
Компактная прочная поверхность
耐用和紧凑的表面



Facili da pulire
Easy to clean
Pflegeleicht
Faciles à nettoyer
Fáciles de limpiar
Легкие в очистке
易于清洁



Resistenti al gelo
Frost resistant
Frostbeständig
Résistant au gel
Resistentes al hielo
Морозоустойчивы
耐冻性



Non combustibili
Non-combustible
Nicht brennbar
Non combustibles
No combustibles
Не горючи
不可燃



Stabili cromaticamente
Colour-stable
Farbbeständig
Stables du point de vue chromatique
Con estabilidad cromática
Устойчивая окраска
色度稳定性

100% BATHROOM

Your OWN AUTHENTIC BATHROOM

Stili, tendenze e idee creative in continuo aggiornamento.

Mirage® propone oltre 30 soluzioni realizzate in un ambiente di due metri per due, che offrono molteplici ispirazioni progettuali per caratterizzare e rendere unico l'ambiente bagno.

 **Maggiori informazioni**
More informations

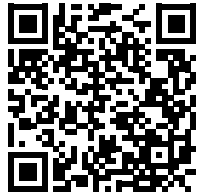

[EN]
Styles, trends and creative ideas are always changing.
Mirage® offers over 30 different solutions within a two-by-two-meter space, providing customers with a wide range of creative options to characterise and distinguish their bathroom space.

[DE]
Eine ständige Aktualisierung der Stile, Tendenzen und kreativen Ideen.
Mirage® bietet mehr als 30 in einem 2x2 Meter großen Raum umgesetzte Lösungen, die zahlreiche Inspirationen für die Planung liefern, um das Badezimmer zu prägen und einmalig zu gestalten.

[FR]
Styles, tendances et idées créatives continuellement mis à jour.
Mirage® propose plus de 30 solutions réalisées dans un environnement de deux mètres sur deux, qui offrent de multiples inspirations conceptuelles afin de caractériser et rendre unique l'espace de la salle de bains.

[ES]
Estilos, tendencias e ideas creativas en continua actualización.
Mirage® propone más de 30 soluciones realizadas en un espacio de dos por dos metros, ofreciendo múltiples inspiraciones de diseño para caracterizar y hacer único el cuarto de baño.

[RU]
Постоянно обновляемые стили, тенденции и креативные идеи.
Компания Mirage® предлагает более 30 решений для помещения площадью два метра на два, дающие многочисленные проектные идеи, позволяющие сделать необычной и уникальной ванную комнату.

[中國]
不断被更新的风格、趋势和创意。
Mirage®为两米乘两米的空间提供30多个解决方案；多种设计灵感使浴室环境变得独一无二。

Con il progetto BATHMOOD, Mirage® propone **soluzioni di interior design** perfettamente coordinabili con pavimenti e rivestimenti.



Una ricca selezione di lavabi da appoggio o freestanding, piatti doccia, specchi, mobili contenitori e sedute, tutti combinabili tra loro e disponibili in molteplici dimensioni.

[EN]
With the BATHMOOD project, Mirage® offers **interior design solutions** that can be perfectly coordinated with floors and coverings. A rich selection of leaning or freestanding washbasins, shower trays, mirrors, container furniture and seats, all combinable between them and available in numerous dimensions.

[DE]
Mit dem Projekt BATHMOOD bietet Mirage® **Innendesign-Lösungen** an, die perfekt auf die Fußböden und Verkleidungen abgestimmt sind. Eine reiche Auswahl an Aufsatz- oder freistehenden Waschbecken, Duschwannen, Spiegeln, Schränken und Sitzmöbeln, die alle miteinander kombiniert werden können und in verschiedenen Größen erhältlich sind.

[FR]
Avec le projet BATHMOOD, Mirage® propose des **solutions de design d'intérieur** qui s'assortissent parfaitement avec des sols et des revêtements. Une riche sélection de lavabos à poser ou autoportants, de receveurs de douche, de miroirs, de meubles de rangement et d'assise, tous combinables entre eux et disponibles en nombreuses dimensions.

[ES]
Con el proyecto BATHMOOD, Mirage® propone **soluciones de diseño de interiores** que pueden coordinarse perfectamente con pavimentos y revestimientos. Una rica selección de lavabos de apoyo o de pedestal, platos de ducha, espejos, muebles y asientos, todos ellos combinables entre sí y disponibles en múltiples dimensiones.

[RU]
В своем проекте BATHMOOD компания Mirage® предлагает **интерьерные решения**, прекрасно сочетающиеся с напольной и настенной облицовкой. Широкий выбор накладных или отдельно стоящих раковин, душевых поддонов, зеркал, корпусной мебели и сидений, комбинируемых между собой и самых различных размеров.

[中國]
通过BATHMOOD项目, Mirage®提供了可以与地砖和墙砖完美搭配的**室内设计解决方案**。这个灵活且不断发展的系列,配置变化多端,可进行几乎无限的组合和具体的解决方案,满足任何需求。

BATHMOOD PROJECT

MIRAGE DESIGN
FURNITURE





Una articolata gamma di colori, effetti e superfici, in grado di assecondare i gusti e le esigenze estetiche più diverse attraverso abbinamenti coordinati o contrasti mix&match.



[EN]
A structured range of colours, effects and finishes, able to satisfy the most varied tastes and aesthetic needs through coordinated combinations or mix&match contrasts.

[DE]
Eine umfassende Palette von Farben, Effekten und Oberflächen abgerundet, die durch koordinierte Kombinationen oder Mix&Match-Kontraste die unterschiedlichsten Vorlieben und ästhetischen Bedürfnisse erfüllen.

[FR]
Une gamme complète de couleurs, d'effets et de surfaces, en mesure de satisfaire les goûts et les exigences esthétiques les plus diverses à travers des assortiments coordonnés ou des contrastes mix&match.

[ES]
Una gama articulada de colores, efectos y acabados, capaz de satisfacer los gustos y las exigencias estéticas más diversas mediante combinaciones coordinadas o contrastes mix&match.

[RU]
Богатый выбор цветов, эффектов и поверхностей способен удовлетворить самые разнообразные вкусы и эстетические требования посредством координированных или контрастных сочетаний «mix&match».

[中國]
丰富多样的颜色、效果和表面处理，可增强功能性设计，通过协调的组合或精致的混搭，可以满足最多样化的品味和审美需求。

HO.RE.CA DESIGN

Solutions for
HOSPITALITY



La ricca offerta Bathmood si amplia con **nuove soluzioni** specificatamente studiate per il mondo **hospitality: Joy e Glad HO.RE.CA.**



Soluzioni progettate appositamente per Hotel, Ristoranti, Spa, per soddisfare le esigenze specifiche di questi spazi, coniugando stile e funzionalità, facilità di pulizia e manutenzione.



[EN]
The rich Bathmood collection has been expanded, with **new solutions** specifically studied for the world of **hospitality: Joy and Glad HO.RE.CA.** Solutions designed specifically with Hotels, Restaurants and Spas in mind, to meet the specific needs of these environments by teaming style with function, for bathrooms that are easy to clean and maintain.

[DE]
Das reichhaltige Bathmood-Angebot wird durch **neue Lösungen erweitert**, die speziell für die Welt des **Gastgewerbes** entwickelt wurden: **Joy und Glad HO.RE.CA.** Lösungen, die speziell für Hotels, Restaurants und Spas entwickelt wurden, um den besonderen Anforderungen dieser Bereiche gerecht zu werden, indem sie Stil und Funktionalität, einfache Reinigung und Pflege miteinander verbinden.

[FR]
L'offre étendue de Bathmood s'amplifie grâce à de **nouvelles solutions** réalisées spécialement pour le monde de l'**hospitalité : Joy et Glad HO.RE.CA.** Des solutions conçues sur mesure pour les hôtels, les restaurants et les spas afin de satisfaire les exigences spécifiques de ces espaces, en réunissant le style, la fonctionnalité et la facilité de nettoyage et d'entretien.

[ES]
La magnífica oferta Bathmood se amplía con **nuevas soluciones** dedicadas especialmente al mundo de la **hostelería: Joy y Glad HO.RE.CA.** Unas soluciones diseñadas expresamente para Hoteles, Restaurantes, Spas, con la finalidad de satisfacer las necesidades típicas de estos espacios, combinando estilo y funcionalidad, facilidad de limpieza y de mantenimiento.

[RU]
Широкий ассортимент коллекции Bathmood обогатился новыми решениями, специально разработанными для мира **туриндустрии: Joy и Glad HO.RE.CA.** Это решения, специально разработанные для гостиниц, ресторанов, Спа-центров для удовлетворения специфических потребностей этих структур, в которых сочетаются стиль и функциональность, а также легкость в уборке и уходе.

[中國]
Bathmood提供的多种产品还包括专为酒店业设计的全新解决方案：**Joy和Glad HO.RE.CA.** 专为酒店、餐厅和水疗中心设计的解决方案，以便满足这些空间的特殊需求，兼具时尚性和功能性，易于清洁和维护。

MIRAGE BOOK
2024

COLLECTIONS

Collezioni | Kollektionen | Collections
Colecciones | Коллекции | 系列



RIGHT WALL: Delight **CL 02** 1200x2780 / 48"x110" SP RECT
REAR WALL and BENCH: Delight **CL 02** 600x1200 / 24"x48" SP RECT
FLOOR: **CL 02** Patchy 400x347 / 15¾"x13¾" SP
FURNITURE: BATHMOOD Happiness **CP 03** LUC

CLAY

For architecture and design, resin and concrete are an excellent planning and style resource, ideal for creating striking effects

Clay features the coated effect typical of resin, with a slightly shiny effect on a matt surface, in a palette of dense colours, suitable for bringing a touch of character to any setting.



WALL: Grace **CL 10** 400x800 / 15¾"x31½" SP RECT
FLOOR: JURUPA Master **JP 03** 200x1200 / 8"x48" NAT RECT

COLORI

Colours | Farben | Couleurs | Colores | Цветов | 种颜色



WALL: Awake **CL 03** 1200x2780 / 48"x110" SP RECT
 FLOOR: Awake **CL 03** 800x800 / 31½"x31½" SP RECT
 COUNTER: Karma **CL 08** 400x800 / 15¾"x31½" SP RECT

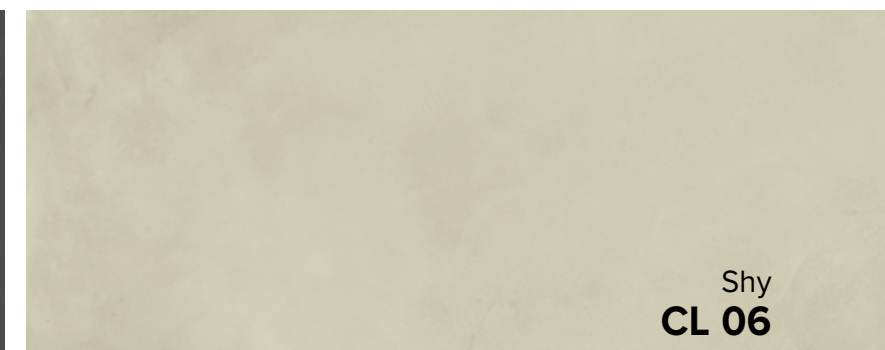



WALL: Calm **CL 01** 1200x2780 / 48"x110" SP RECT
FLOOR: Calm **CL 01** 1200x1200 / 48"x48" SP RECT



WALL: Verve **CL 05** 1200x2780 / 48"x110" SP RECT
FLOOR: JURUPA Camp **JP 04** 200x1200 / 8"x48" NAT RECT



WALL: Shy **CL 06** 1200x2780 / 48"x110" SP RECT
FLOOR: Shy **CL 06** 400x800 / 15¾"x31½" SP RECT
DESK: Verve **CL 05** 1200x2780 / 48"x110" SP RECT

COLORI

Colours | Farben | Couleurs | Colores | Цветов | 种颜色

CALM CL 01



Formati Nominali Nominal Sizes		Superficie Finish	Spessore mm Thickness mm
400x800 / 15¾"x31½"	SP RECT	9	
800x800 / 31½"x31½"	SP RECT	9	
300x600 / 12"x24"	SP RECT	9	
600x600 / 24"x24"	SP RECT	9	
600x1200 / 24"x48"	SP RECT	9	
1200x1200 / 48"x48"	SP RECT	9	
600x1200 / 24"x48"	SP RECT	6	
1200x2780 / 48"x110"	SP RECT	6	

Stucchi consigliati Recommended grouts		
KERAKOLL	20	
MAPEI	111 Grigio Argento	
LATICRETE	44 Bright White	



FANCY CL 04



Formati Nominali Nominal Sizes		Superficie Finish	Spessore mm Thickness mm
400x800 / 15¾"x31½"	SP RECT	9	
800x800 / 31½"x31½"	SP RECT	9	
300x600 / 12"x24"	SP RECT	9	
600x600 / 24"x24"	SP RECT	9	
600x1200 / 24"x48"	SP RECT	9	
1200x1200 / 48"x48"	SP RECT	9	
1200x2780 / 48"x110"	SP RECT	6	

Stucchi consigliati Recommended grouts		
KERAKOLL	09	
MAPEI	112 Grigio Medio	
LATICRETE	78 Sterling Silver	



DELIGHT CL 02



Formati Nominali Nominal Sizes		Superficie Finish	Spessore mm Thickness mm
400x800 / 15¾"x31½"	SP RECT	9	
800x800 / 31½"x31½"	SP RECT	9	
300x600 / 12"x24"	SP RECT	9	
600x600 / 24"x24"	SP RECT	9	
600x1200 / 24"x48"	SP RECT	9	
1200x1200 / 48"x48"	SP RECT	9	
600x1200 / 24"x48"	SP RECT	6	
1200x2780 / 48"x110"	SP RECT	6	

Stucchi consigliati Recommended grouts		
KERAKOLL	06	
MAPEI	110 Manhattan	
LATICRETE	88 Silver Shadow	



VERVE CL 05

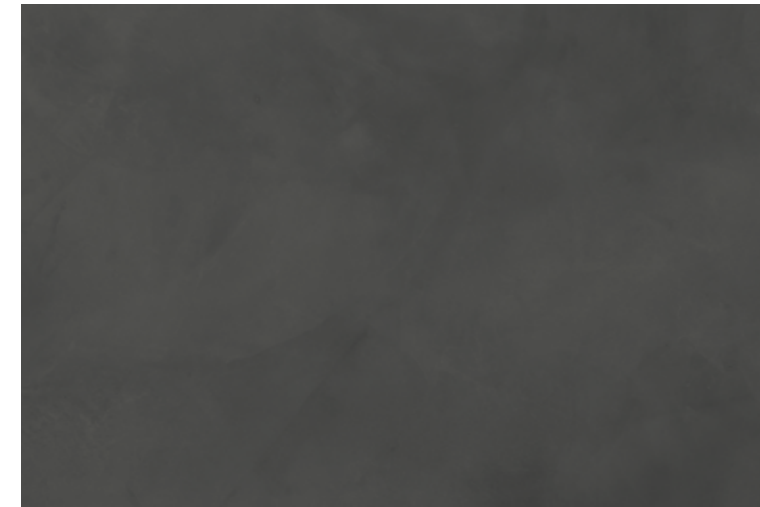

Formati Nominali Nominal Sizes		Superficie Finish	Spessore mm Thickness mm
400x800 / 15¾"x31½"	SP RECT	9	
800x800 / 31½"x31½"	SP RECT	9	
300x600 / 12"x24"	SP RECT	9	
600x600 / 24"x24"	SP RECT	9	
600x1200 / 24"x48"	SP RECT	9	
1200x1200 / 48"x48"	SP RECT	9	
1200x2780 / 48"x110"	SP RECT	6	

Stucchi consigliati Recommended grouts		
KERAKOLL	11	
MAPEI	114 Antracite	
LATICRETE	45 Raven	



AWAKE CL 03



Formati Nominali Nominal Sizes		Superficie Finish	Spessore mm Thickness mm
400x800 / 15¾"x31½"	SP RECT	9	
800x800 / 31½"x31½"	SP RECT	9	
300x600 / 12"x24"	SP RECT	9	
600x600 / 24"x24"	SP RECT	9	
600x1200 / 24"x48"	SP RECT	9	
1200x1200 / 48"x48"	SP RECT	9	
600x1200 / 24"x48"	SP RECT	6	
1200x2780 / 48"x110"	SP RECT	6	

Stucchi consigliati Recommended grouts		
KERAKOLL	08	
MAPEI	112 Grigio Medio	
LATICRETE	78 Sterling Silver	



SHY CL 06



Formati Nominali Nominal Sizes		Superficie Finish	Spessore mm Thickness mm
400x800 / 15¾"x31½"	SP RECT	9	
800x800 / 31½"x31½"	SP RECT	9	
300x600 / 12"x24"	SP RECT	9	
600x600 / 24"x24"	SP RECT	9	
600x1200 / 24"x48"	SP RECT	9	
1200x1200 / 48"x48"	SP RECT	9	
600x1200 / 24"x48"	SP RECT	6	
1200x2780 / 48"x110"	SP RECT	6	

Stucchi consigliati Recommended grouts		
KERAKOLL	21	
MAPEI	137 Caraibi	
LATICRETE	90 Light Pewter	



COLORI

Colours | Farben | Couleurs | Colores | Цветов | 种颜色

TRUST CL 07



Formati Nominali Nominal Sizes		Superficie Finish	Spessore mm Thickness mm
400x800 / 15¾"x31½"		SP RECT	9
800x800 / 31½"x31½"		SP RECT	9
300x600 / 12"x24"		SP RECT	9
600x600 / 24"x24"		SP RECT	9
600x1200 / 24"x48"		SP RECT	9
1200x1200 / 48"x48"		SP RECT	9
600x1200 / 24"x48"		SP RECT	6
1200x2780 / 48"x110"		SP RECT	6

Stucchi consigliati Recommended grouts	
KERAKOLL	45
MAPEI	112 Grigio Medio
LATICRETE	24 Natural Grey



GRACE CL 10

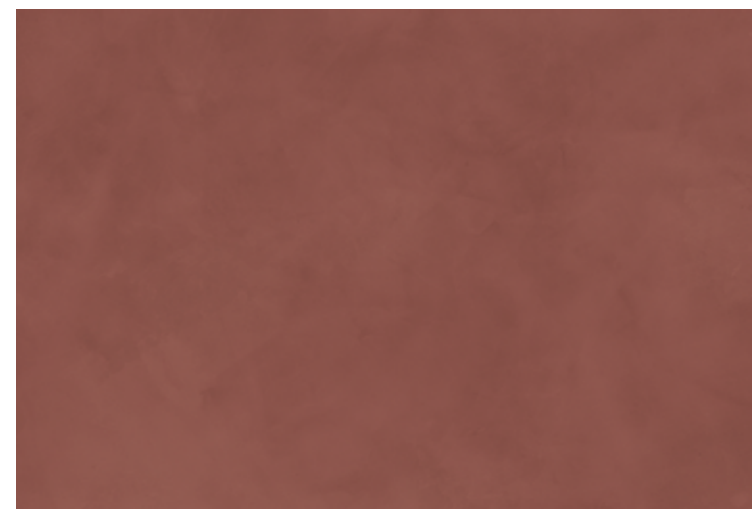

Formati Nominali Nominal Sizes		Superficie Finish	Spessore mm Thickness mm
400x800 / 15¾"x31½"		SP RECT	9
600x1200 / 24"x48"		SP RECT	9

Stucchi consigliati Recommended grouts	
KERAKOLL	40
MAPEI	114 Antracite
LATICRETE	45 Raven



KARMA CL 08

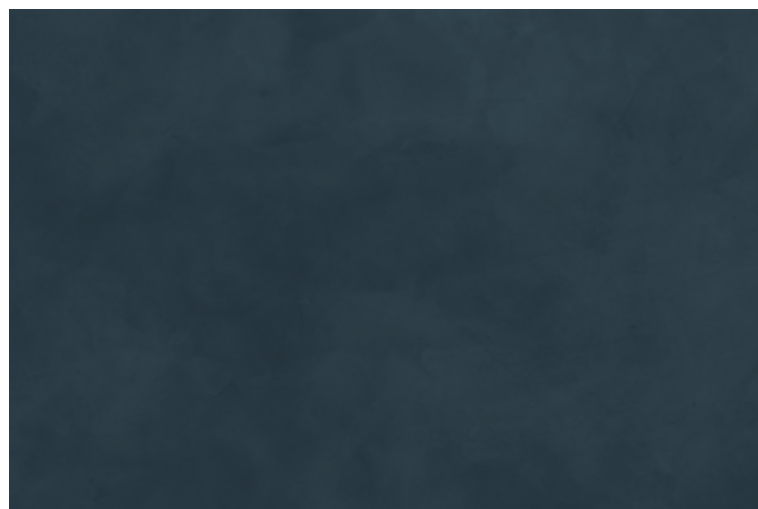

Formati Nominali Nominal Sizes		Superficie Finish	Spessore mm Thickness mm
400x800 / 15¾"x31½"		SP RECT	9
600x1200 / 24"x48"		SP RECT	9
1200x2780 / 48"x110"		SP RECT	6

Stucchi consigliati Recommended grouts	
KERAKOLL	16
MAPEI	174 Tornado
LATICRETE	53 Twilight Blue



GLEE CL 09

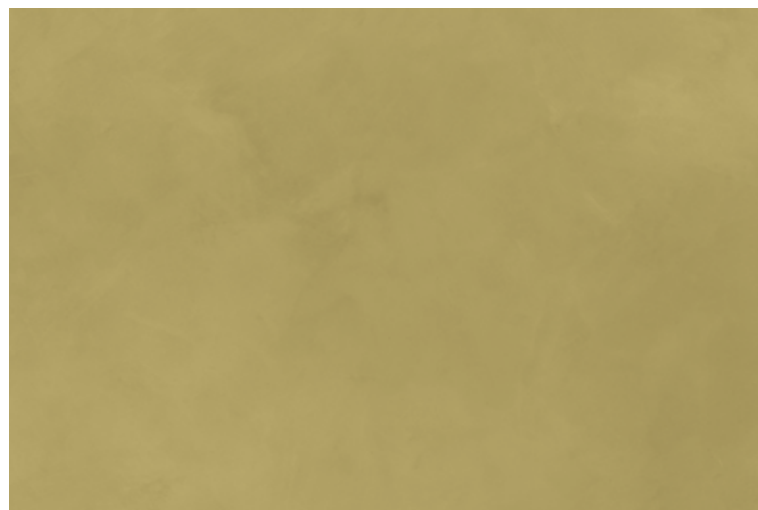

Formati Nominali Nominal Sizes		Superficie Finish	Spessore mm Thickness mm
400x800 / 15¾"x31½"		SP RECT	9
600x1200 / 24"x48"		SP RECT	9

Stucchi consigliati Recommended grouts	
KERAKOLL	07
MAPEI	113 Grigio Cemento
LATICRETE	78 Sterling Silver



MY NOTES

.....

.....

.....

.....

.....

.....

Maggiori informazioni
More information



SP: Spazzolata

RIASSUNTIVO FORMATI ED IMBALLI

Summary of sizes and packaging | Übersicht über Formate und Verpackungen | Récapitulatif formats et emballages
Sinóptico de formatos y embalajes | Краткая информация о форматах и упаковках | 规格和包装概述

		± 9 mm					
Formati Nominali Nominal Sizes		400x800 15¾"x31½"	800x800 31½"x31½"	300x600 12"x24"	600x600 24"x24"	600x1200 24"x48"	1200x1200 48"x48"
Tutti i formati sono rettificati. All sizes are rectified.							
Superficie Finish		SP	SP	SP	SP	SP	SP
CALM CL 01	V2	■	■	■	■	■	■
DELIGHT CL 02	V2	■	■	■	■	■	■
AWAKE CL 03	V2	■	■	■	■	■	■
FANCY CL 04	V2	■	■	■	■	■	■
VERVE CL 05	V2	■	■	■	■	■	■
SHY CL 06	V2	■	■	■	■	■	■
TRUST CL 07	V2	■	■	■	■	■	■
KARMA CL 08	V2	■	-	-	-	■	-
GLEE CL 09	V2	■	-	-	-	■	-
GRACE CL 10	V2	■	-	-	-	■	-
Peso lordo per scatola Gross weight per box		27,30	25,23	25,58	22,13	29,60	61,56
Pezzi per scatola Pieces for box		4	2	7	3	2	2
mq. scatola sqm. box		1,28	1,28	1,26	1,08	1,44	2,88
Scatole / Full pallet boxes / Full pallet		28	48	40	40	35	20
mq. pallet sqm. pallet		35,84	61,44	50,40	43,20	50,40	57,60

		± 6 mm	
Formati Nominali Nominal Sizes		600x1200 24"x48"	1200x2780 48"x110"
Tutti i formati sono rettificati. All sizes are rectified.			
Superficie Finish		SP	SP
CALM CL 01	V2	■	■
DELIGHT CL 02	V2	■	■
AWAKE CL 03	V2	■	■
FANCY CL 04	V2	-	■
VERVE CL 05	V2	-	■
SHY CL 06	V2	■	■
TRUST CL 07	V2	■	■
KARMA CL 08	V2	-	■
GLEE CL 09	V2	-	-
GRACE CL 10	V2	-	-
Peso lordo per scatola Gross weight per box		32,20	
Pezzi per scatola Pieces for box		3	Please refer to page 588
mq. scatola sqm. box		2,16	
Scatole / Full pallet boxes / Full pallet		25	
mq. pallet sqm. pallet		54,00	

Per tutti i grandi formati è possibile prevedere, su richiesta, e con un lotto minimo l'applicazione di una stuoia in fibra di vetro.
For big sizes, a fibreglass mat can be applied on request, with a minimum production batch.

PEZZI SPECIALI

Special pieces | Sonderstücke | Pièces spéciales | Piezas especiales | специальные изделия | 特殊件

	Battiscopa*	Gradino A*	Gradino A*	Gradino G*	
Pezzi speciali Special pieces	72x600 27½"x24"	72x800 27½"x31½"	330x800 13½"x31½"	330x1200 13½"x48"	330x800 13½"x31½"
Superficie Finish	SP	SP	SP	SP	SP
CALM CL 01	■	■	■	■	■
DELIGHT CL 02	■	■	■	■	■
AWAKE CL 03	■	■	■	■	■
FANCY CL 04	■	■	■	■	■
VERVE CL 05	■	■	■	■	■
SHY CL 06	■	■	■	■	■
TRUST CL 07	■	■	■	■	■
KARMA CL 08	■	■	■	■	■
GLEE CL 09	■	■	■	■	■
GRACE CL 10	■	■	■	■	■
Pezzi per scatola Pieces for box	10	10	7	4	7

* Finitura a becco di civetta | One-round edge shaping | Ausführung mit Eckabrundung | Façonnage à bord rond | Acabado canto romo | Плитка с завалом | 鹰嘴边缘处理

	Gradino B ang.	Gradino B	Gradino B	Gradino B
Pezzi speciali Special pieces	330x330 13½"x13½"	330x600 13½"x24"	330x800 13½"x31½"	330x1200 13½"x48"
Superficie Finish	SP	SP	SP	SP
CALM CL 01	■	■	■	■
DELIGHT CL 02	■	■	■	■
AWAKE CL 03	■	■	■	■
FANCY CL 04	■	■	■	■
VERVE CL 05	■	■	■	■
SHY CL 06	■	■	■	■
TRUST CL 07	■	■	■	■
KARMA CL 08	■	■	■	■
GLEE CL 09	■	■	■	■
GRACE CL 10	■	■	■	■
Pezzi per scatola Pieces for box	4	4	4	2

ACCORGIMENTI SPECIFICI PER L'APPLICAZIONE DELLE GRANDI LASTRE IN 6 MM DI SPESSORE: p. 582 | Precautions for 6mm big slabs applications: page 582 | spezifische Anweisungen zur Nutzung der Grossformate in 6mm: seite 582 | Precauciones específicas para la aplicación de las grandes placas en 6 mm de espesor: page 582 | Precautions spécifiques pour la pose des grandes plaques en 6mm d'épaisseur: página 582 | специальные предосторожности для укладки больших плит толщиной 6 мм : страница 582

DECORI

Decors | Dekore | Decors | Decoros | Декоры | 装饰砖

Mosaico 36T SP
300x300 / 12"x12"
Tessere 48x48 / 2"x2"

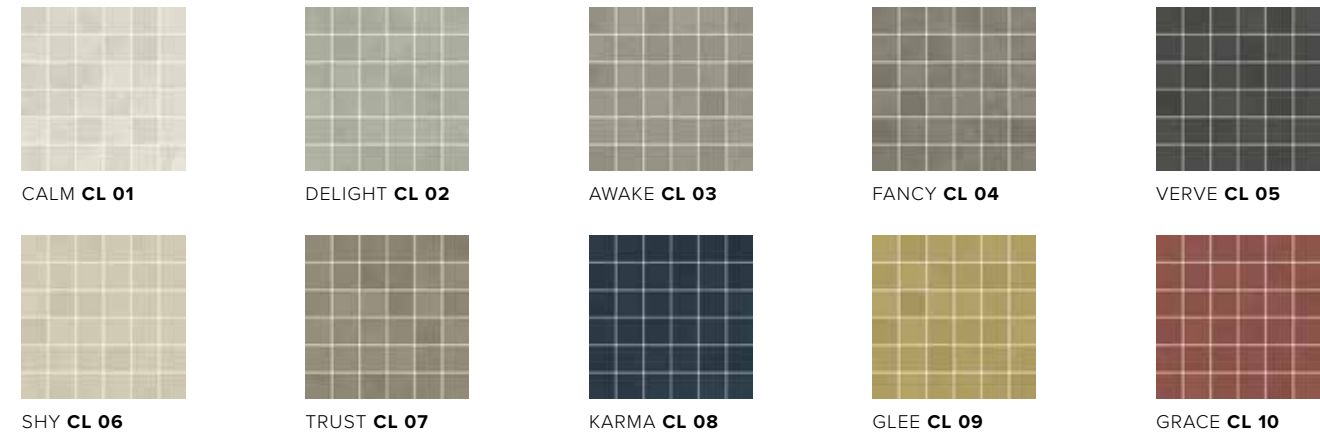

Tribend SP
300x300 / 12"x12"
Tessere 14x95 / 3/4"x3 3/8"

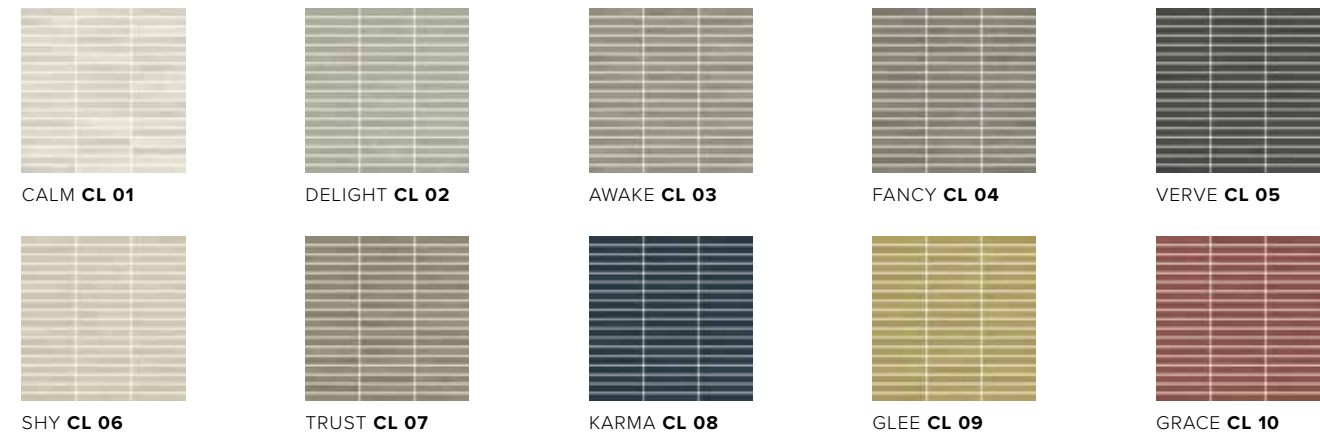

Patchy SP
400x347 / 15 3/4"x13 3/8"



DECORI

Decors | Dekore | Decors | Decoros | Декоры | 装饰砖

Nest SP
210x420 / 8 1/2"x17"

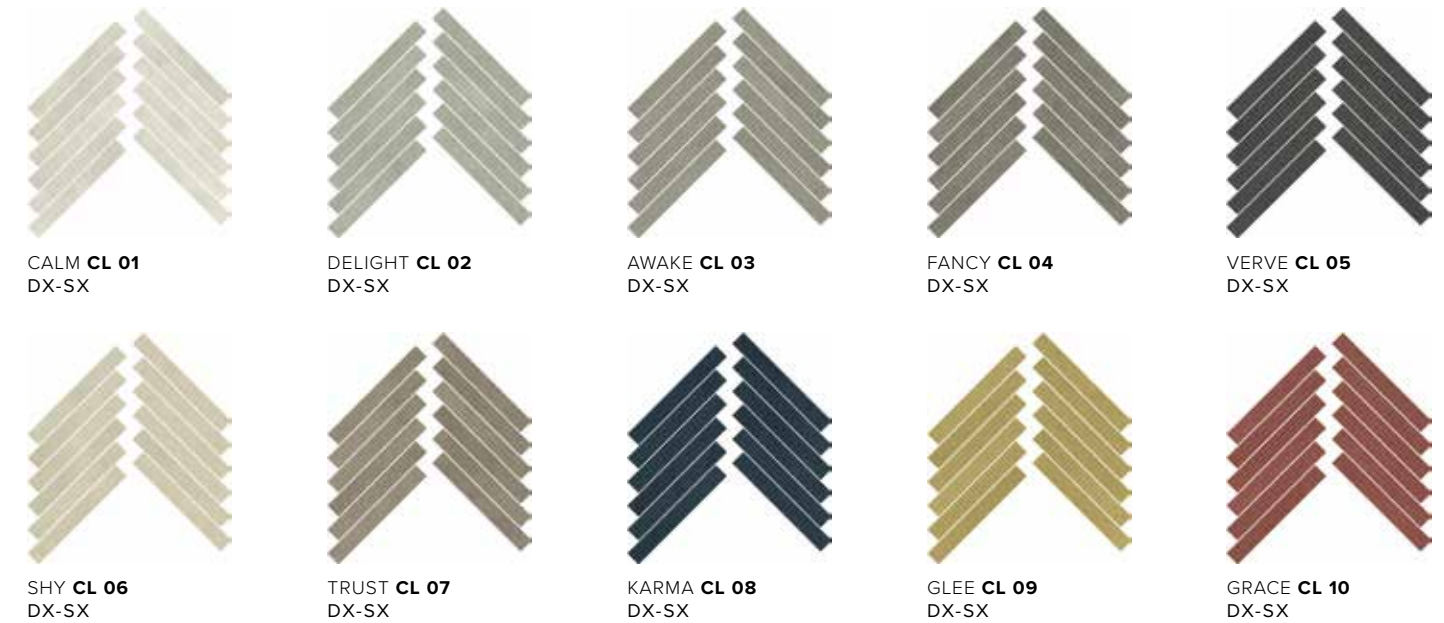

Curtain SP
400x400 / 15 3/4"x15 3/4"

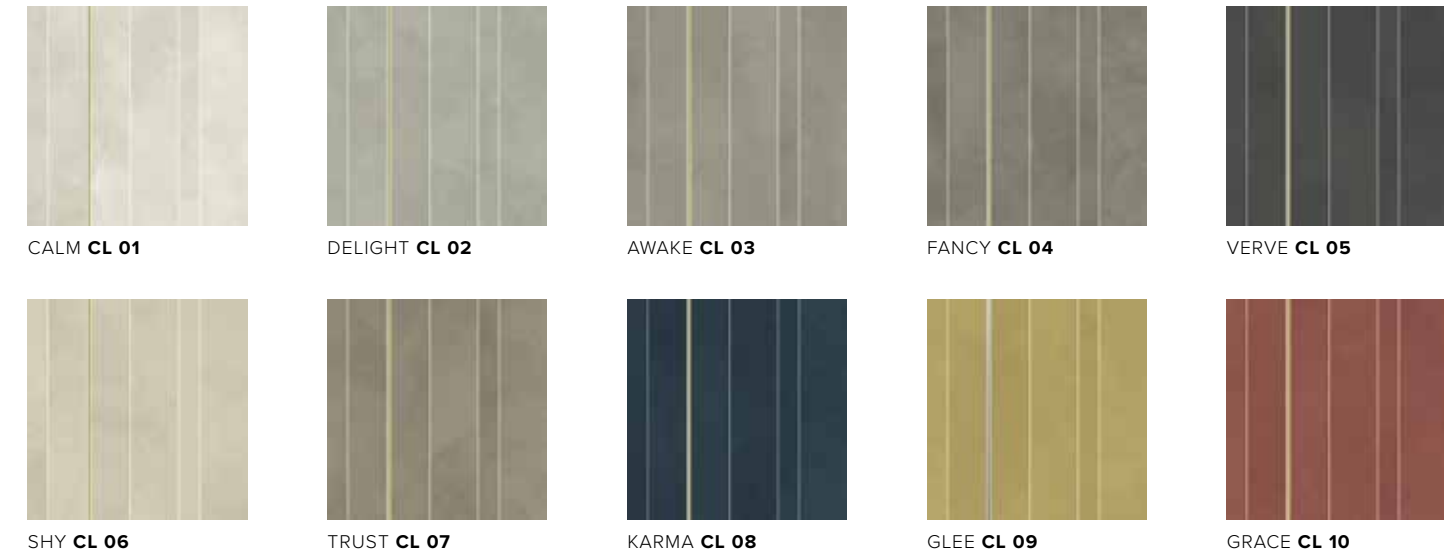

Pezzi per scatola Pieces for box	
Mosaico 36T	6
Tribend	6
Patchy	6
Nest	3sx + 3dx
Curtain	6

MOSAICO 36T, TRIBEND, PATCHY, NEST, CURTAIN:
Decoro su rete | Mesh-backed decoration | Dekor auf netz | Décor sur filet | Decoración en red | Декор в сетку | 网板背帖装饰件



WALL: Glee **CL 09** 400x800 / 15¾"x31½" SP RECT
 FLOOR: Calm **CL 01** 800x800 / 31½"x31½" SP RECT

CARATTERISTICHE TECNICHE

Technical specifications | Technische Eigenschaften | Caractéristiques techniques | Características técnicas | Технические характеристики | 技术特征

STANDARD EN 14411 - G

	CARATTERISTICHE TECNICHE TECHNICAL DATA TECHNISCHE DATEN CARACTERISTIQUES TECHNIQUES CARACTERÍSTICAS TÉCNICAS ТЕХНИЧЕСКИЕ ХАРАКТЕРИСТИКИ 技术特征	NORMA STANDARD NORM NORME NORMA НОРМА ЗНАЧЕНИЯ 标准	VALORI PRESCRITTI DALLE NORME EN 14411 - G INTERNATIONAL STANDARDS EN 14411 - G INTERNATIONALE NORMWERTE EN 14411 - G VALEURS PREVUES PAR LES NORMES EN 14411 - G VALORES PREVISTOS POR LAS NORMAS EN 14411 - G ПРЕДУСМОТРЕННЫЕ СТАНДАРТОМ EN 14411-G EN 14411 - G标准规定值	*VALORE MEDIO MIRAGE MIRAGE AVERAGE VALUE MIRAGE MITTELWERT VALEURS MOYEN MIRAGE VALOR MEDIO MIRAGE СРЕДНЕЕ ЗНАЧЕНИЕ MIRAGE MIRAGE平均值
	CARATTERISTICHE DIMENSIONALI - SIZE CHARACTERISTICS - MASSEIGENSCHAFTEN DETERMINATION DES CARACTERISTIQUES DIMENSIONNELLES - CARACTERÍSTICAS DIMENSIONALES - РАЗМЕРНЫЕ ХАРАКТЕРИСТИКИ - 尺寸特征			
	LATI SIDES - SEITEN COTES - CANTOS РАЗМЕРЫ СТОРОН - 侧边	EN ISO 10545-2	± 0,3% MAX (± 1,0 mm MAX)	CONFORME COMPLYING
	SPESSORE THICKNESS - DICKE ÉPAISSEUR - ESPESOR ТОЛЩИНА - 厚度	EN ISO 10545-2	± 5,0% MAX (± 0,5 mm MAX)	CONFORME COMPLYING
	RETTILINEITÀ DEGLI SPIGOLI STRAIGHTNESS OF SIDES - GERADLINIGKEIT DER KANTEN RECTITUDE DES ARETES - RECTITUD DE LOS CANTOS КОСОУГОЛЬНОСТЬ - 边角平直度	EN ISO 10545-2	± 0,3% MAX (± 0,8 mm MAX)	CONFORME COMPLYING
	ORTOGONALITÀ RECTANGULARITY - RECHTWINKLIGKEIT PERPENDICULARITÉ - ORTOGONALIDAD КРИВИЗНА СТОРОН - 直角度	EN ISO 10545-2	± 0,3% MAX (± 1,5 mm MAX)	CONFORME COMPLYING
	PLANARITÀ SURFACE FLATNESS - EBENFLÄCHIGKEIT PLANEITE DE SURFACE - PLANEIDAD КРИВИЗНА ЛИЦЕВОЙ ПОВЕРХНОСТИ - 平整度	EN ISO 10545-2	± 0,4% MAX (± 1,8 mm MAX)	CONFORME COMPLYING
	ASSORBIMENTO D'ACQUA WATER ABSORPTION - WASSERAUFNAHME ABSORPTION D'EAU - ABSORCIÓN DE AGUA ВОДОПОГЛОЩЕНИЕ - 吸水率	EN ISO 10545-3	≤ 0,5%	≤ 0,1%
	RESISTENZA ALLA FLESSIONE FLEXION RESISTANCE - BIEGEFESTIGKEIT RESISTANCE A LA FLEXION - RESISTENCIA A LA FLEXIÓN ПРЕДЕЛ ПРОЧНОСТИ ПРИ ИЗГИБЕ - 抗弯强度	EN ISO 10545-4	S ≥ 700 N (< 7,5 mm) S ≥ 1.300 N (> 7,5 mm) R ≥ 35 N/mm ² .	± 6 mm: S ≥ 1100N R ≥ 45 N/mm ² ± 9 mm: S ≥ 2.400N R ≥ 48 N/mm ²
	RESISTENZA ALL'URTO IMPACT RESISTANCE - STOSSFESTIGKEIT RESISTANCE AUX CHOCS - RESISTENCIA A LOS GOLPES УДАРСТОЙКОСТЬ - 抗冲击强度	EN ISO 10545-5	VALORE DICHIARATO DECLARED VALUE	> 0,80
	RESISTENZA ALL'ABRASIONE ABRASION RESISTANCE - ABRIEBFESTIGKEIT RESISTANCE A L'ABRASION - RESISTENCIA A LA ABRASIÓN СТОЙКОСТЬ К ИСТИРАНИЮ - 耐磨强度	EN ISO 10545-6	≤ 175 mm ³	< 150 mm ³
	COEFFICIENTE DI DILATAZIONE TERMICA LINEARE COEFFICIENT OF LINEAR THERMAL-EXPANSION - LINEARER WÄRMEAUDEHNUNGSKOEFFIZIENT COEFFICIENT DE DILATATION THERMIQUE LINEAIRE - COEFFICIENT DE DILATACIÓN TÉRMICA LINEAL КОЭФФИЦИЕНТ ЛИНЕЙНОГО ТЕРМИЧЕСКОГО РАСТЯЖЕНИЯ - 线性热膨胀系数	EN ISO 10545-8	-	α=6,6x10 ⁻⁶ °C ⁻¹
	RESISTENZA AGLI SBALZI TERMICI RESISTANCE TO THERMAL SHOCKS - BESTÄNDIGKEIT GEGEN TEMPERATURSCHWANKUNGEN RESISTANCE AUX CHOCS THERMIQUES - RESISTENCIA A LOS CHOQUES TÉRMICOS СТОЙКОСТЬ К ПЕРЕПАДАМ ТЕМПЕРАТУРЫ - 耐热突变性	EN ISO 10545-9	TEST SUPERATO SECONDO EN ISO 10545-1 PASS ACCORDING EN ISO 10545-1	NESSUN DANNO NO DAMAGE
	RESISTENZA AL GELO FROST RESISTANCE - FROSTBESTÄNDIGKEIT RESISTANCE AU GEL - RESISTENCIA AL HIELO МОРОЗОСТОЙКОСТЬ - 耐冻性	EN ISO 10545-12	TEST SUPERATO SECONDO EN ISO 10545-1 PASS ACCORDING EN ISO 10545-1	NESSUN DANNO NO DAMAGE
	RESISTENZA ALL'ATTACCO CHIMICO RESISTANCE TO CHEMICALS - CHEMIKALIENBESTÄNDIGKEIT RESISTANCE A L'ATTAQUE CHIMIQUE - RESISTENCIA QUÍMICA ХИМИЧЕСКАЯ СТОЙКОСТЬ - 耐化学品作用	EN ISO 10545-13	B MIN.	A LA HA
	RESISTENZA ALLE MACCHIE RESISTANCE TO STAINS - FLECKENBESTÄNDIGKEIT RESISTANCE AUX TACHES - RESISTENCIA A LAS MANCHAS УСТОЙЧИВОСТЬ К ПЯТНООБРАЗОВАНИЮ - 防污性	EN ISO 10545-14	VALORE DICHIARATO DECLARED VALUE	5
	CESSIONE DI PIOMBO E CADMIO LEAD AND CADMIUM DISCHARGE - ABGABE VON BLEI UND CADMIUM PERTE DE PLOMB ET CADMIUM - CESIÓN DE PLOMO Y CADMIO ВЫДЕЛЕНИЕ СВИНЦА И КАДМИЯ - 铅和镉的排放	EN ISO 10545-15	VALORE DICHIARATO DECLARED VALUE	< AL LIMITE DI RILEVAMENTO < THAN INSTRUMENT LIMIT
				SP
		DM 236/89 BCRA	> 0,40	> 0,40
		ANSI A326.3	Wet and Dry	≥ 0,42
		AS 4586	-	P2
		DIN 51130	-	R9
		DIN 51097	-	-
		UNE 41901	≥ CL1	CL1
		BS 7976 sl.96-4S	Wet and Dry	-
		BS 7976 sl.55-TRL	Wet and Dry	-

Per i certificati specifici, contattare Mirage SpA - For specific certificates, please contact Mirage SpA - Für die speziellen Zertifikate wenden Sie sich bitte an Mirage SpA - Pour les certificats spécifiques, veuillez contacter Mirage SpA
 Para los certificados específicos, contactar Mirage SpA - Для сертификатов обращайтесь в компанию Mirage SpA - 关于具体的证书, 请联系Mirage SpA公司



FLOOR: Calacatta Gold CP 02 1200x1200 / 48"x48" LUC RECT
WALL: Calacatta Gold CP 02 1200x2780 / 48"x110" LUC RECT

COSMOPOLITAN

A collection of **UNIQUE** and **EXCLUSIVE** marbles in porcelain stoneware to mimic the depth and the wealth of detail and the random veining patterns.

A collection in which each slab offers all the thrill of a work of art.



Calacatta Gold CP 02 1200x1200 / 48"x48" LUC RECT

COLORI

Colours | Farben | Couleurs | Colores | Цветов | 种颜色

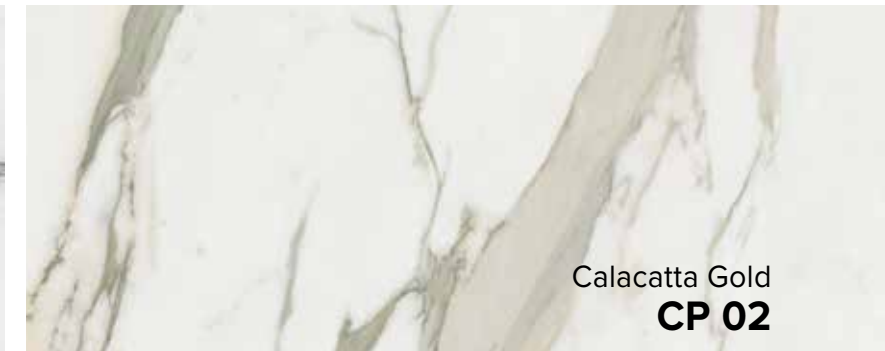

WALL: Mystic Grey **CP 06** 1200x2780 / 48"x110" LUC RECT - Plume **CP 06** 300x300 / 12"x12" LUC
 FLOOR: Mystic Grey **CP 06** 800x800 / 31½"x31½" LUC RECT
 FURNITURE: BATHMOOD Appeal **CL 07** SP + BATHMOOD Freedom **CL 07** SP + BATHMOOD Vertical Bliss Mirror **CL 07** SP



ESSENCE
★★★★★

WALL: Arabescato Oro **CP 03** 1200x2780 / 48"x110" LUC RECT / GLOCAL Sugar **GC 07** 1200x2780 / 48"x110" SP RECT
FLOOR: Arabescato Oro **CP 03** 1200x1200 / 48"x48" LUC RECT
COUNTERTOP: GLOCAL Sugar **GC 07** SP

COLORI

Colours | Farben | Couleurs | Colores | Цветов | 种颜色

STATUARIO EXTRA **CP 01**



	Formati Nominali Nominal Sizes		Superficie Finish		Spessore mm Thickness mm
	800x800 / 31½"x31½"		NAT / LUC RECT.		9
	800x1600 / 31½"x63"		LUC RECT		9
	600x1200 / 48"x48"		LUC RECT		9
	1200x1200 / 48"x48"		LUC RECT		9
	1200x2400 / 48"x96"		LUC RECT		9
	1200x2780 / 48"x110"		NAT / LUC RECT		6
	Stucchi consigliati Recommended grouts				
	KERAKOLL	03			
	MAPEI	103 Bianco Luna			
	LATICRETE	44 Bright White			

CALACATTA GOLD **CP 02**



	Formati Nominali Nominal Sizes		Superficie Finish		Spessore mm Thickness mm
	800x800 / 31½"x31½"		NAT / LUC RECT.		9
	800x1600 / 31½"x63"		LUC RECT		9
	600x1200 / 48"x48"		LUC RECT		9
	1200x1200 / 48"x48"		LUC RECT		9
	1200x2400 / 48"x96"		LUC RECT		9
	1200x2780 / 48"x110"		NAT / LUC RECT.		6
	Stucchi consigliati Recommended grouts				
	KERAKOLL	03			
	MAPEI	103 Bianco Luna			
	LATICRETE	44 Bright White			

ARABESCATO ORO **CP 03**



	Formati Nominali Nominal Sizes		Superficie Finish		Spessore mm Thickness mm
	800x800 / 31½"x31½"		LUC RECT		9
	800x1600 / 31½"x63"		LUC RECT		9
	600x1200 / 48"x48"		LUC RECT		9
	1200x1200 / 48"x48"		LUC RECT		9
	1200x2400 / 48"x96"		LUC RECT		9
	1200x2780 / 48"x110"		LUC RECT		6
	Stucchi consigliati Recommended grouts				
	KERAKOLL	20			
	MAPEI	103 Bianco Luna			
	LATICRETE	44 Bright White			

STATUARIO FANTASTICO **CP 04**



	Formati Nominali Nominal Sizes		Superficie Finish		Spessore mm Thickness mm
	1200x2780 / 48"x110"		LUC RECT		6
	Stucchi consigliati Recommended grouts				
	KERAKOLL	03			
	MAPEI	103 Bianco Luna			
	LATICRETE	44 Bright White			

WHITE CRYSTAL **CP 05**



	Formati Nominali Nominal Sizes		Superficie Finish		Spessore mm Thickness mm
	800x800 / 31½"x31½"		LUC RECT		9
	800x1600 / 31½"x63"		LUC RECT		9
	600x1200 / 48"x48"		LUC RECT		9
	1200x1200 / 48"x48"		LUC RECT		9
	1200x2400 / 48"x96"		LUC RECT		9
	1200x2780 / 48"x110"		LUC RECT		6
	Stucchi consigliati Recommended grouts				
	KERAKOLL	43			
	MAPEI	111 Grigio Argento			
	LATICRETE	88 Silver Shadow			

MYSTIC GREY **CP 06**



	Formati Nominali Nominal Sizes		Superficie Finish		Spessore mm Thickness mm
	800x800 / 31½"x31½"		LUC RECT		9
	800x1600 / 31½"x63"		LUC RECT		9
	600x1200 / 48"x48"		LUC RECT		9
	1200x1200 / 48"x48"		LUC RECT		9
	1200x2400 / 48"x96"		LUC RECT		9
	1200x2780 / 48"x110"		LUC RECT		6
	Stucchi consigliati Recommended grouts				
	KERAKOLL	05			
	MAPEI	112 Grigio Medio			
	LATICRETE	89 Smoke Grey			

COLORI

Colours | Farben | Couleurs | Colores | Цветов | 种颜色

AMAZZONITE **CP 07**



Formati Nominali Nominal Sizes	Superficie Finish	Spessore mm Thickness mm
800x800 / 31½"x31½"	LUC RECT	9
800x1600 / 31½"x63"	LUC RECT	9
600x1200 / 48"x48"	LUC RECT	9
1200x1200 / 48"x48"	LUC RECT	9
1200x2400 / 48"x96"	LUC RECT	9
1200x2780 / 48"x110"	LUC RECT	6

Stucchi consigliati Recommended grouts	
KERAKOLL	10
MAPEI	113 Grigio Cemento
LATICRETE	78 Sterling Silver



WALL: White Crystal **CP 05** 1200x2780 / 48"x110" LUC RECT
 FLOOR: White Crystal **CP 05** 1200x1200 / 48"x48" LUC RECT

RIASSUNTIVO FORMATI ED IMBALLI

Summary of sizes and packaging | Übersicht über Formate und Verpackungen | Récapitulatif formats et emballages
Sinóptico de formatos y embalajes | Краткая информация о форматах и упаковках | 规格和包装概述

Formati Nominali Nominal Sizes		800x800 31½"x31½"		800x1600 31½"x63"		600x1200 24"x48"		1200x1200 48"x48"		1200x2400 48"x96"	
Tutti i formati sono rettificati. All sizes are rectified.											
Superficie Finish		NAT		LUC		LUC		LUC		LUC	
STATUARIO EXTRA CP 01	V2	■	■	■	■	■	■	■	■	■	■
CALACATTA GOLD CP 02	V2	■	■	■	■	■	■	■	■	■	■
ARABESCATO ORO CP 03	V2	-	■	■	■	■	■	■	■	■	■
STATUARIO FANTASTICO CP 04	V2	-	-	-	-	-	-	-	-	-	-
WHITE CRYSTAL CP 05	V2	-	■	■	■	■	■	■	■	■	■
MYSTIC GREY CP 06	V2	-	■	■	■	■	■	■	■	■	■
AMAZZONITE CP 07	V2	-	■	■	■	■	■	■	■	■	■
Peso lordo per scatola Gross weight per box		27,36		27,36		55,12		30,30		61,56	
Pezzi per scatola Pieces for box		2		2		2		2		2	
mq. scatola sqm. box		1,28		1,28		2,56		1,44		2,88	
Scatole / Full pallet boxes / Full pallet		48		48		16		35		20	
mq. pallet sqm. pallet		61,44		61,44		40,96		50,40		57,60	
Please refer to page 588											

Per tutti i grandi formati è possibile prevedere, su richiesta, e con un lotto minimo l'applicazione di una stuoia in fibra di vetro.
For big sizes, a fibreglass mat can be applied on request, with a minimum production batch.

Formati Nominali Nominal Sizes		1200x2780 48"x110"		* Kit Vein Matching 1200x2780 48"x110"		Bookmatch 1200x2780 48"x110"	
Tutti i formati sono rettificati. All sizes are rectified.							
Superficie Finish		LUC		NAT		LUC	
		A_LUC		B_LUC			
STATUARIO EXTRA CP 01	V2	■	■	■	■	■	■
CALACATTA GOLD CP 02	V2	■	■	■	■	■	■
ARABESCATO ORO CP 03	V2	■	■	-	■	■	■
STATUARIO FANTASTICO CP 04	V2	■	-	-	-	-	-
WHITE CRYSTAL CP 05	V2	■	-	-	-	-	-
MYSTIC GREY CP 06	V2	■	-	-	-	-	-
AMAZZONITE CP 07	V2	■	-	-	-	-	-
Peso lordo per scatola Gross weight per box		Please refer to page 588		Please refer to page 588		Please refer to page 588	
Pezzi per scatola Pieces for box		Please refer to page 588		Please refer to page 588		Please refer to page 588	
mq. scatola sqm. box		Please refer to page 588		Please refer to page 588		Please refer to page 588	
Scatole / Full pallet boxes / Full pallet		Please refer to page 588		Please refer to page 588		Please refer to page 588	
mq. pallet sqm. pallet		Please refer to page 588		Please refer to page 588		Please refer to page 588	

* Kit Vein Matching (5 pz / 5 pcs)

PEZZI SPECIALI

Special pieces | Sonderstücke | Pièces spéciales | Piezas especiales | специальные изделия | 特殊件

		Battiscopa*		Gradino A*		Gradino A*		Gradino G*	
Pezzi speciali Special pieces		72x800 27/8"x24"		330x800 13/5"x31½"		330x1200 13/5"x48"		330x800 13/5"x31½"	
Superficie Finish		LUC		NAT		LUC		LUC	
		NAT		LUC		NAT		LUC	
STATUARIO EXTRA CP 01		■	■	■	■	■	■	■	■
CALACATTA GOLD CP 02		■	■	■	■	■	■	■	■
ARABESCATO ORO CP 03		■	-	■	■	-	■	-	■
STATUARIO FANTASTICO CP 04		-	-	-	-	-	-	-	-
WHITE CRYSTAL CP 05		■	-	■	■	■	-	■	■
MYSTIC GREY CP 06		■	-	■	■	■	-	■	■
AMAZZONITE CP 07		■	-	■	■	■	-	■	■
Pezzi per scatola Pieces for box		10		7		7		4	

* Finitura a becco di civetta | One-round edge shaping | Ausführung mit Eckabrundung | Façonnage à bord rond | Acabado canto romo | Плитка с завалом | 鹰嘴边缘处理

		Gradino B ang.		Gradino B		Gradino B	
Pezzi speciali Special pieces		330x330 13/5"x13/5"		330x800 13/5"x31½"		330x1200 13/5"x48"	
Superficie Finish		NAT		LUC		LUC	
		NAT		LUC		LUC	
STATUARIO EXTRA CP 01		■	■	■	■	■	■
CALACATTA GOLD CP 02		■	■	■	■	■	■
ARABESCATO ORO CP 03		-	■	-	■	■	■
STATUARIO FANTASTICO CP 04		-	-	-	-	-	-
WHITE CRYSTAL CP 05		-	■	-	■	■	■
MYSTIC GREY CP 06		-	■	-	■	■	■
AMAZZONITE CP 07		-	■	-	■	■	■
Pezzi per scatola Pieces for box		4		4		4	

MY NOTES

.....

.....

.....

.....

.....

Maggiori informazioni
More information



DECORI

Decors | Dekore | Decors | Decoros | Декоры | 装饰砖

Mosaico 144 LUC
300x300 / 12"x12"
Tessere 22x22 / 4/5"x4/5"

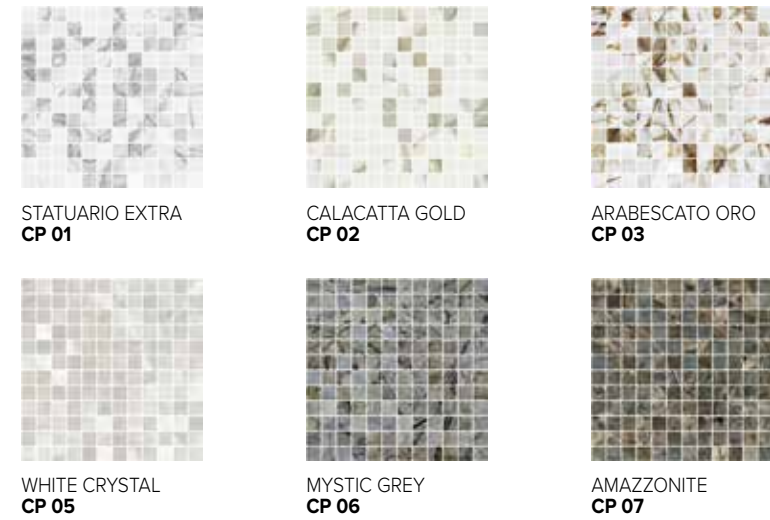

Mosaico 36T LUC
300x300 / 12"x12"
Tessere 48x48 / 2"x2"



Foliage LUC
323x305 / 12 3/4"x12"



Plume LUC
300x300 / 12"x12"



 Pezzi per scatola Pieces for box	
Mosaico 144	6
Mosaico 36T	6
Foliage	10
Plume	6

Kit speciali per posa a macchia aperta.

CP 01, 02 e 03 sono disponibili anche in speciali kit che permettono di realizzare la posa **“BOOK MATCHING”** o **“DIAMOND MATCHING”**.

Le composizioni possono essere abbinare al fondo, di cui mantengono formato e calibro. Per un risultato ancora più ricercato e prezioso.

CP 01, 02 and 03 are also available in special kits that can be used for the **“Book Matching”** or **“Diamond Matching”** laying schemes. The compositions can be combined with the base tiles, which have the same size and worksite, for an even more beautiful, sophisticated effect.

FORMATI / SIZES:

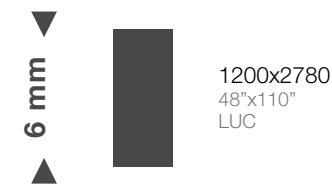

COLORI / COLOURS:

CP 01 STATUARIO EXTRA

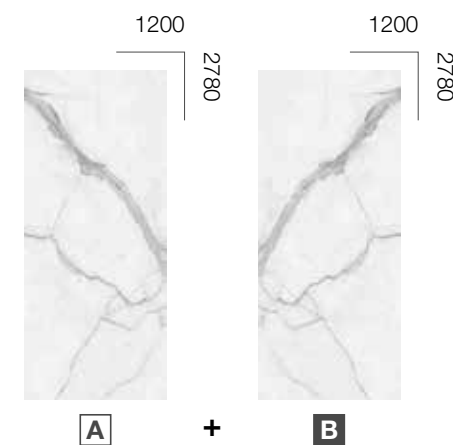

CP 02 CALACATTA GOLD

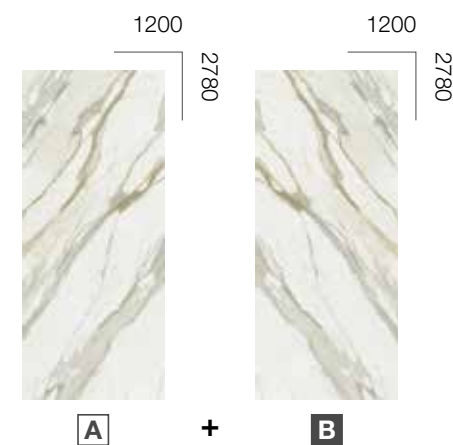

CP 03 ARABESCATO ORO

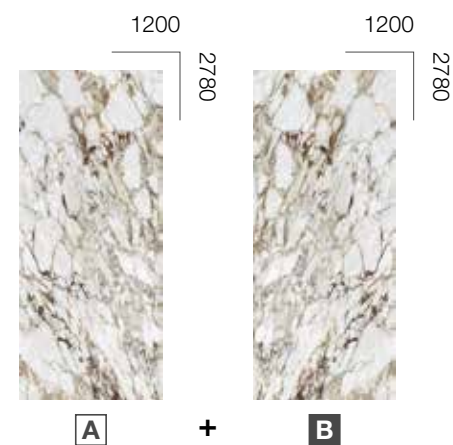

CP 01, 02 et 03 existent aussi en kits spéciaux qui permettent de réaliser la pose « **Book Matching** » ou « **Diamond Matching** ». Les compositions peuvent être associées au fond, dont elles gardent le format et le calibre. Pour un résultat encore plus raffiné et plus précieux.

CP 01, 02 und 03 sind auch in speziellen Sets erhältlich, die die Verlegung **“Book Matching”** oder **“Diamond Matching”** ermöglichen. Die Kompositionen können mit dem Untergrund kombiniert werden, dessen Format und Ausmaß beibehalten wird. Für ein noch erleseneres und wertvolleres Ergebnis.

CP 01, 02 y 03 también están disponibles en kits especiales que permiten realizar la colocación **“Book Matching”** o **“Diamond Matching”**. Las composiciones pueden ser combinadas con el fondo, del que mantienen el formato y calibre. Para un resultado aún más refinado y precioso.

Изделия CP 01, 02 и 03 представлены также в специальных комплектах для укладки по схеме **“открытая книга” (Book Matching)** или **“ромб” (Diamond Matching)**. Такие композиции можно сочетать с фоновой плиткой с соблюдением ее формата и размера, чтобы в результате дизайн поверхности был еще более изысканным и элегантным.

CP 01, 02和03还有特殊套件, 可以实现 **“书页式对拼”** 或 **“钻石对拼”** 铺设。组合可以与底砖匹配, 保持其尺寸和口径, 旨在追求更加考究和精美的效果。

ALCUNI ESEMPI DI COMPOSIZIONE / LAYING PATTERN PROPOSALS:

CP 01 - 1200x2780 / 48"x110" LUC

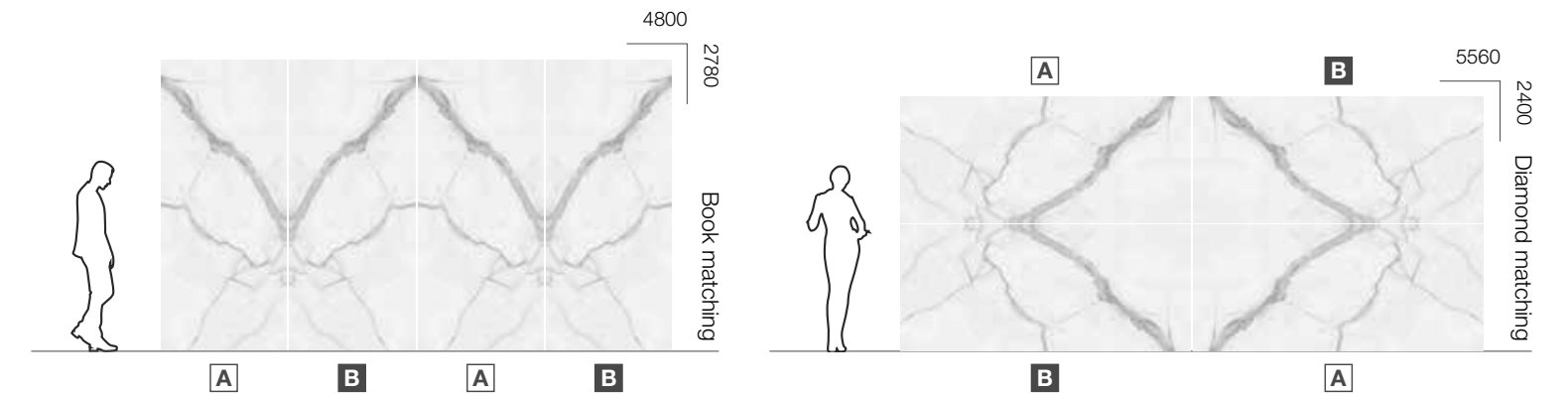

CP 02 - 1200x2780 / 48"x110" LUC



CP 03 - 1200x2780 / 48"x110" LUC



Il processo produttivo non garantisce la continuità nel disegno della venatura tra i vari pezzi spediti. Eventuali disallineamenti tra le venature in continuità sono da considerarsi caratteristica intrinseca del prodotto. L'immagine rappresentata serve a dare un'idea indicativa del prodotto, toni e venature possono essere quindi suscettibili di variazioni.

The production process does not guarantee continuity in the design of the veining among the various pieces provided. Any misalignment between the continuous veining is to be considered an intrinsic characteristic of the product. The image shown is merely indicative; the shades and veinings of the product may be subject to variations.

Kit Vein Matching.

Per offrire un servizio sempre più personalizzato, Mirage® mette a disposizione il Kit Vein Matching nei colori CP 01 e CP 02 in formato 1200x2780 mm, superficie lucida.

Il kit è composto da 5 lastre numerate e dalle grafiche sequenziali ad effetto vena continua.

For an increasingly customised service, Mirage® offers the Vein Matching Kit in the colours CP 01 and CP02, in the 1200x2780 mm, polished surface.

The kit is composed of 5 numbered slabs and sequential patterns that create a continuous vein effect.

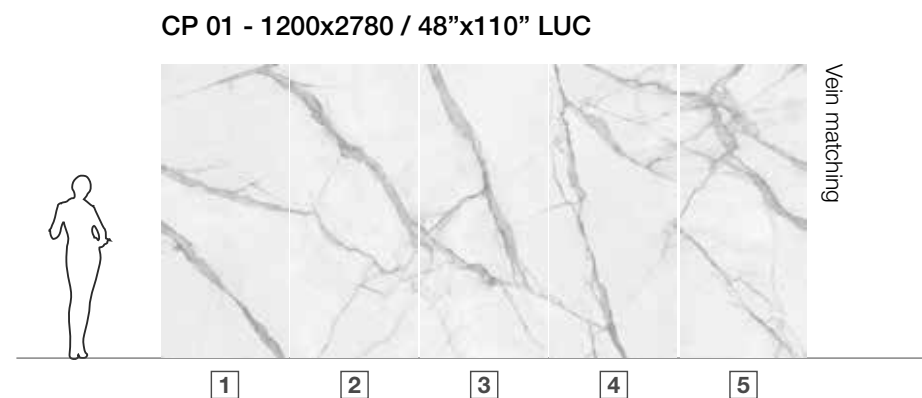
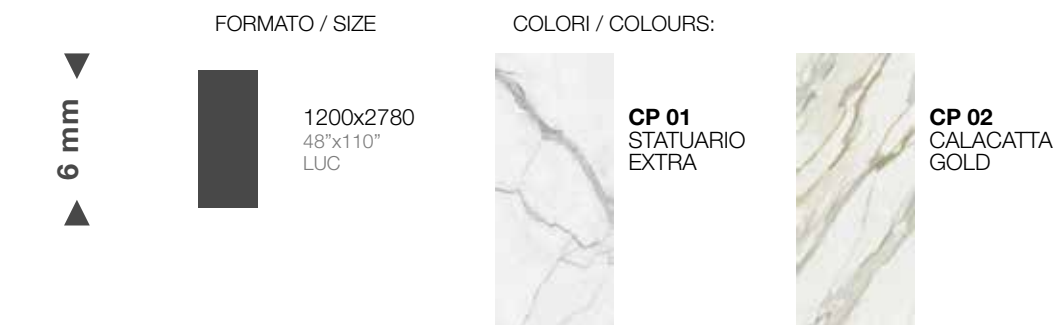

Il processo produttivo non garantisce la continuità nel disegno della venatura tra i vari pezzi spediti. Eventuali disallineamenti tra le venature in continuità sono da considerarsi caratteristica intrinseca del prodotto. L'immagine rappresentata serve a dare un'idea indicativa del prodotto, toni e venature possono essere quindi suscettibili di variazioni.

The production process does not guarantee continuity in the design of the veining among the various pieces provided. Any misalignment between the continuous veining is to be considered an intrinsic characteristic of the product. The image shown is merely indicative; the shades and veinings of the product may be subject to variations.

CARATTERISTICHE TECNICHE

Technical specifications | Technische Eigenschaften | Caractéristiques techniques | Características técnicas | Технические характеристики | 技术特征

STANDARD EN 14411 - G

NORMA STANDARD NORME NORMA ЗНАЧЕНИЯ 标准	VALORI PRESCRITTI DALLE NORME EN 14411 - G INTERNATIONALE NORMWERTE EN 14411 - G VALEURS PREVUES PAR LES NORMES EN 14411 - G VALORES PREVISTOS POR LAS NORMAS EN 14411 - G ПРЕДУСМОТРЕННЫЕ СТАНДАРТОМ EN 14411-G EN 14411 - G标准规定值	VALORE MEDIO MIRAGE MIRAGE AVERAGE VALUE MIRAGE MITTELWERT VALORS MOYEN MIRAGE VALOR MEDIO MIRAGE СРЕДНЕЕ ЗНАЧЕНИЕ MIRAGE MIRAGE平均值	
		LUC (GL)	NAT (UGL)
CARATTERISTICHE TECNICHE TECHNICAL DATA TECHNISCHE DATEN CARACTERISTIQUES TECHNIQUES CARACTERÍSTICAS TÉCNICAS ТЕХНИЧЕСКИЕ ХАРАКТЕРИСТИКИ 技术特征			
CARATTERISTICHE DIMENSIONALI - SIZE CHARACTERISTICS - MASSEIGENSCHAFTEN DETERMINATION DES CARACTERISTIQUES DIMENSIONNELLES - CARACTERÍSTICAS DIMENSIONALES - РАЗМЕРНЫЕ ХАРАКТЕРИСТИКИ - 尺寸特征			
LATI SIDES - SEITEN COTES - CANTOS РАЗМЕРЫ СТОРОН - 侧边	EN ISO 10545-2	± 0,3% MAX (± 1,0 mm MAX)	CONFORME COMPLYING
SPESSORE THICKNESS - DICKE ÉPAISSEUR - ESPESOR ТОЛЩИНА - 厚度	EN ISO 10545-2	± 5,0% MAX (± 0,5 mm MAX)	CONFORME COMPLYING
RETTILINEITÀ DEGLI SPIGOLI STRAIGHTNESS OF SIDES - GERADLINIGKEIT DER KANTEN RECTITUDE DES ARETES - RECTITUD DE LOS CANTOS КОСОУГОЛЬНОСТЬ - 边角平直度	EN ISO 10545-2	± 0,3% MAX (± 0,8 mm MAX)	CONFORME COMPLYING
ORTOGONALITÀ RECTANGULARITY - RECHTWINKLIGKEIT PERPENDICULARITÉ - ORTOGONALIDAD КРИВИЗНА СТОРОН - 直角度	EN ISO 10545-2	± 0,3% MAX (± 1,5 mm MAX)	CONFORME COMPLYING
PLANARITÀ SURFACE FLATNESS - EBENFLÄCHIGKEIT PLANEITE DE SURFACE - PLANEIDAD КРИВИЗНА ЛИЦЕВОЙ ПОВЕРХНОСТИ - 平整度	EN ISO 10545-2	± 0,4% MAX (± 1,8 mm MAX)	CONFORME COMPLYING
ASSORBIMENTO D'ACQUA WATER ABSORPTION - WASSERAUFNAHME ABSORPTION D'EAU - ABSORCIÓN DE AGUA ВОДОПОГЛОЩЕНИЕ - 吸水率	EN ISO 10545-3	≤ 0,5%	≤ 0,1%
RESISTENZA ALLA FLESSIONE FLEXION RESISTANCE - BIEGEFESTIGKEIT RESISTANCE A LA FLEXION - RESISTENCIA A LA FLEXIÓN ПРЕДЕЛ ПРОЧНОСТИ ПРИ ИЗГИБЕ - 抗弯强度	EN ISO 10545-4	S ≥ 700 N (< 7,5 mm) S ≥ 1.300 N (> 7,5 mm) R ≥ 0,48 N/mm ² .	± 6 mm: S ≥ 1100 N R ≥ 45 N/mm ² ± 9 mm: S ≥ 2.500 N R ≥ 48 N/mm ²
RESISTENZA ALL'URTO IMPACT RESISTANCE - STOSSFESTIGKEIT RESISTANCE AUX CHOCS - RESISTENCIA A LOS GOLPES УДАРСТОЙКОСТЬ - 抗冲击强度	EN ISO 10545-5	VALORE DICHIARATO DECLARED VALUE	> 0,80
RESISTENZA ALL'ABRASIONE ABRASION RESISTANCE - ABRIEFESTIGKEIT RESISTANCE A L'ABRASION - RESISTENCIA A LA ABRASIÓN СТОЙКОСТЬ К ИСТИРАНИЮ - 耐磨强度	EN ISO 10545-6	≤ 175 mm ³	< 150 mm ³
COEFFICIENTE DI DILATAZIONE TERMICA LINEARE COEFFICIENT OF LINEAR THERMAL EXPANSION - LINEARER WÄRMEAUDEHNUNGSKOEFFIZIENT COEFFICIENT DE DILATATION THERMIQUE LINEAIRE - COEFFICIENTE DE DILATACIÓN TÉRMICA LINEAL КОЭФФИЦИЕНТ ЛИНЕЙНОГО ТЕРМИЧЕСКОГО РАСТЯЖЕНИЯ - 线性热膨胀系数	EN ISO 10545-8	-	α 6,2x10 ⁻⁶ /°C ⁻¹
RESISTENZA AGLI SBALZI TERMICI RESISTANCE TO THERMAL SHOCKS - BESTÄNDIGKEIT GEGEN TEMPERATURSCHWANKUNGEN RESISTANCE AUX CHOCS THERMIQUES - RESISTENCIA A LOS CHOQUES TÉRMICOS СТОЙКОСТЬ К ПЕРЕПАДАМ ТЕМПЕРАТУРЫ - 耐热突变性	EN ISO 10545-9	TEST SUPERATO SECONDO EN ISO 10545-1 PASS ACCORDING EN ISO 10545-1	NESSUN DANNO NO DAMAGE
RESISTENZA AL GELO FROST RESISTANCE - FROSTBESTÄNDIGKEIT RESISTANCE AU GEL - RESISTENCIA AL HIELO МОРОЗОСТОЙКОСТЬ - 耐冻性	EN ISO 10545-12	TEST SUPERATO SECONDO EN ISO 10545-1 PASS ACCORDING EN ISO 10545-1	NESSUN DANNO NO DAMAGE
RESISTENZA ALL'ATTACCO CHIMICO RESISTANCE TO CHEMICALS - CHEMIKALIENBESTÄNDIGKEIT RESISTANCE A L'ATTAQUE CHIMIQUE - RESISTENCIA A LA ABRASIÓN QUÍMICA ХИМИЧЕСКАЯ СТОЙКОСТЬ - 耐化学品作用	EN ISO 10545-13	B MIN.	A LA A LA HA
RESISTENZA ALL'ABRASIONE SUPERFICIALE SURFACE ABRASION RESISTANCE - ABRIEFESTIGKEIT DER OBERFLÄCHE RESISTANCE A L'ABRASION SUPERFICIELLE - RESISTENCIA A LA ABRASIÓN SUPERFICIAL ХИМИЧЕСКАЯ СТОЙКОСТЬ - 耐表面磨损	EN ISO 10545-7	-	LUC PEI 5 (CP 01 - 02 - 03 - 04 - 05 - 06) PEI 4 (CP 07)
RESISTENZA ALLE MACCHIE RESISTANCE TO STAINS - FLECKENBESTÄNDIGKEIT RESISTANCE AUX TACHES - RESISTENCIA A LAS MANCHAS УСТОЙЧИВОСТЬ К ПЯТНООБРАЗОВАНИЮ - 防污性	EN ISO 10545-14	VALORE DICHIARATO DECLARED VALUE	5
CESSIONE DI PIOMBO E CADMIO LEAD AND CADMIUM DISCHARGE - ABGABE VON BLEI UND CADMIUM PERTE DE PLOMB ET CADMIUM - CESIÓN DE PLOMO Y CADMIO ВЫДЕЛЕНИЕ СВИНЦА И КАДМИЯ - 铅和镉的排放	EN ISO 10545-15	VALORE DICHIARATO DECLARED VALUE	< AL LIMITE DI RILEVAMENTO < THAN INSTRUMENT LIMIT
			LUC NAT
	DM 236/89 BCRA	> 0,40	> 0,40
	ANSI A326.3	Wet and Dry	≥ 0,42
	AS 4586	-	P2
	DIN 51130	-	R9
	DIN 51097	-	-
	UNE 41901	≥ CL1	CL1
	BS 7976 sl.96-4S	Wet and Dry	-
	BS 7976 sl.55-TRL	Wet and Dry	-
SCIVOLOSITÀ SKID RESISTANCE - RUTSCHWERT GLISSANCE - ADHERENCIA СКОЛЬЗКОСТЬ - 防滑性			

Per i certificati specifici, contattare Mirage SpA - For specific certificates, please contact Mirage SpA - Für die speziellen Zertifikate wenden Sie sich bitte an Mirage SpA - Pour les certificats spécifiques, veuillez contacter Mirage SpA - Para los certificados específicos, contactar Mirage SpA - Для сертификатов обращайтесь в компанию Mirage SpA - 关于具体的证书,请联系 Mirage SpA 公司

* La superficie LUC può essere soggetta a graffi se in contatto con materiali più duri (es sassi, frammenti di piastrella, etc...) LUC finish can be subjected to scratches if in contact with harder materials (eg stones, tile fragments, etc...)



WALL: Rochepot **DJ 03** 150x150 / 6"x6" SP RECT
FLOOR: Kit Fontainebleau Rochepot **DJ 03**
300x200 12"x8" - 300x400 12"x16" - 600x600 24"x24" NAT RECT

DIJON

Dijon is a contemporary expression of traditional Burgundy Limestone.

This collection teams its ancient allure with a modern touch, shaping living spaces in which the past engages with the present. The shades in the collection vary from warm beige to deep brown and elegant anthracite, evoking the unique elegance of the stone.



FLOOR: Bazoches **DJ 04** 600x600 / 24"x24" SP RECT

COLORI

Colours | Farben | Couleurs | Colores | Цветов | 种颜色



WALL: Rochepot **DJ 03** 600x1200 / 24"x48" SP RECT
FLOOR: Exà Rochepot **DJ 03** 300x400 / 12"x15¾" SP



Couches
DJ 01

Commarin
DJ 02

Rochepot
DJ 03

Bazoches
DJ 04

Cormatin
DJ 05



FLOOR: Couches **DJ 01** 600x600 / 24"x24" + 600x900 / 24"x36" + 600x1200 / 24"x48" ST RECT EVO_2/E" ± 20 mm
TABLE: EVO_LIVING Eden 90x90 + Eden 100x200
TABLE TOP: ELYSIAN Desert Stone **EY 02** SP



WALL: Cormatin **DJ 05** 300x600 / 12"x24" SP RECT
Soap Cormatin **DJ 05** 380x400 / 15"x15¾" SP
FLOOR: Cormatin **DJ 05** 600x1200 / 24"x48" SP RECT
WASH BASIN: BATHMOOD Joy **GC 06** SP



WALL: Soap Cormatin **DJ 05** 380x400 / 15"x15¾" SP
WASH BASIN: BATHMOOD Joy **GC 06** SP

COLORI

Colours | Farben | Couleurs | Colores | Цветов | 种颜色

Couches DJ 01



Formati Nominali Nominal Sizes	Superficie Finish	Spessore mm Thickness mm
150x150 / 6"x6"	SP RECT	9
300x300 / 12"x12"	SP RECT	9
300x600 / 12"x24"	SP / ST RECT	9
600x600 / 24"x24"	SP / LAPP RECT	9
600x1200 / 24"x48"	SP / LAPP RECT	9
600x600 / 24"x24"	ST RECT	20
600x900 / 24"x36"	ST RECT	20
600x1200 / 24"x48"	ST RECT	20

Stucchi consigliati Recommended grouts		
KERAKOLL	43	
MAPEI	133	
LATICRETE	23 Antique White	

Bazoches DJ 04



Formati Nominali Nominal Sizes	Superficie Finish	Spessore mm Thickness mm
150x150 / 6"x6"	SP RECT	9
300x300 / 12"x12"	SP RECT	9
300x600 / 12"x24"	SP / ST RECT	9
600x600 / 24"x24"	SP / LAPP RECT	9
600x1200 / 24"x48"	SP / LAPP RECT	9
600x600 / 24"x24"	ST RECT	20
600x900 / 24"x36"	ST RECT	20
600x1200 / 24"x48"	ST RECT	20

Stucchi consigliati Recommended grouts		
KERAKOLL	07	
MAPEI	112 Grigio Medio	
LATICRETE	78 Sterling Silver	

Commarin DJ 02



Formati Nominali Nominal Sizes	Superficie Finish	Spessore mm Thickness mm
150x150 / 6"x6"	SP RECT	9
300x300 / 12"x12"	SP RECT	9
300x600 / 12"x24"	SP / ST RECT	9
600x600 / 24"x24"	SP / LAPP RECT	9
600x1200 / 24"x48"	SP / LAPP RECT	9
600x600 / 24"x24"	ST RECT	20
600x900 / 24"x36"	ST RECT	20
600x1200 / 24"x48"	ST RECT	20

Stucchi consigliati Recommended grouts		
KERAKOLL	05	
MAPEI	110 Manhattan	
LATICRETE	90 Light Pewter	

Cormatin DJ 05



Formati Nominali Nominal Sizes	Superficie Finish	Spessore mm Thickness mm
150x150 / 6"x6"	SP RECT	9
300x300 / 12"x12"	SP RECT	9
300x600 / 12"x24"	SP / ST RECT	9
600x600 / 24"x24"	SP / LAPP RECT	9
600x1200 / 24"x48"	SP / LAPP RECT	9

Stucchi consigliati Recommended grouts		
KERAKOLL	08	
MAPEI	119	
LATICRETE	45 Raven	

Rocheport DJ 03



Formati Nominali Nominal Sizes	Superficie Finish	Spessore mm Thickness mm
150x150 / 6"x6"	SP RECT	9
300x300 / 12"x12"	SP RECT	9
300x600 / 12"x24"	SP / ST RECT	9
600x600 / 24"x24"	SP / LAPP RECT	9
600x1200 / 24"x48"	SP / LAPP RECT	9
600x600 / 24"x24"	ST RECT	20
600x900 / 24"x36"	ST RECT	20
600x1200 / 24"x48"	ST RECT	20

Stucchi consigliati Recommended grouts		
KERAKOLL	05	
MAPEI	187	
LATICRETE	90 Light Pewter	

RIASSUNTIVO FORMATI ED IMBALLI

Summary of sizes and packaging | Übersicht über Formate und Verpackungen | Récapitulatif formats et emballages
Sinóptico de formatos y embalajes | Краткая информация о форматах и упаковках | 规格和包装概述

		9 mm							
Formati Nominali Nominal Sizes		150x150 6"x6"	300x300 12"x12"	300x600 12"x24"	600x600 24"x24"	600x1200 24"x48"			
Tutti i formati sono rettificati. All sizes are rectified.									
Superficie Finish		SP	SP	SP	ST	SP	LAPP	SP	LAPP
Couches DJ 01	V3	■	■	■	■	■	■	■	■
Commarin DJ 02	V3	■	■	■	■	■	■	■	■
Rocheport DJ 03	V3	■	■	■	■	■	■	■	■
Bazoches DJ 04	V3	■	■	■	■	■	■	■	■
Cormatin DJ 05	V3	■	■	■	■	■	■	■	■
Peso lordo per scatola Gross weight per box		11,24	22,50	25,58	25,58	22,12	22,12	30,00	30,00
Pezzi per scatola Pieces for box		28	12	7	7	3	3	2	2
mq. scatola sqm. box		0,63	1,08	1,26	1,26	1,08	1,08	1,44	1,44
Scatole / Full pallet boxes / Full pallet		68	48	40	40	40	40	35	35
mq. pallet sqm. pallet		42,84	51,84	50,40	50,40	43,20	43,20	50,40	50,40

		GO 2/° 20 mm		
Formati Nominali Nominal Sizes		600x600 24"x24"	600x900 24"x36"	600x1200 24"x48"
Tutti i formati sono rettificati. All sizes are rectified.				
Superficie Finish		ST	ST	ST
Couches DJ 01	V3	■	■	■
Commarin DJ 02	V3	■	■	■
Rocheport DJ 03	V3	■	■	■
Bazoches DJ 04	V3	■	■	■
Cormatin DJ 05	V3	-	-	-
Peso lordo per scatola Gross weight per box		31,15	47,00	32,00
Pezzi per scatola Pieces for box		2	2	1
mq. scatola sqm. box		0,72	1,08	0,72
Scatole / Full pallet boxes / Full pallet		30	24	35
mq. pallet sqm. pallet		21,60	25,92	25,20

PEZZI SPECIALI

Special pieces | Sonderstücke | Pièces spéciales | Piezas especiales | специальные изделия | 特殊件

	Battiscopa*	Gradino A*	Gradino A*	Gradino G*
Pezzi speciali Special pieces	72x600 27/8"x24"	300x600 12"x24"	330x1200 13 1/2"x48"	300x600 12"x24"
Superficie Finish	SP	SP	SP	SP
Couches DJ 01	■	■	■	■
Commarin DJ 02	■	■	■	■
Rocheport DJ 03	■	■	■	■
Bazoches DJ 04	■	■	■	■
Cormatin DJ 05	■	■	■	■
Pezzi per scatola Pieces for box	10	7	4	7

* **Finitura a becco di civetta** | One-round edge shaping | Ausführung mit Eckabrundung
Façonnage à bord rond | Acabado canto romo | Плитка с завалом | 鷹嘴边缘处理

	Gradino B ang.	Gradino B	Gradino B
Pezzi speciali Special pieces	330x330 13 1/2"x13 1/2"	330x600 13 1/2"x24"	330x1200 13 1/2"x48"
Superficie Finish	SP	SP	SP
Couches DJ 01	■	■	■
Commarin DJ 02	■	■	■
Rocheport DJ 03	■	■	■
Bazoches DJ 04	■	■	■
Cormatin DJ 05	■	■	■
Pezzi per scatola Pieces for box	4	4	2

MY NOTES

.....

.....

.....

.....

.....

Maggiori informazioni
More information



ST: Strutturata | Structured | Strukturiert | Structuré | Estructurado | Труктурированный | 结构
SP: Spazzolata
LAPP: Lappata

DECORI

Decors | Dekore | Decors | Decoros | Декоры | 装饰砖

Mosaico 36T SP
300x300 / 12"x12"
Tessere 48x48 / 2"x2"



Exà SP
300x400 / 12"x15¾"



Soap SP
380x400 / 15"x15¾"
Bordi arrotondati / Rounded edges



Pezzi per scatola
Pieces for box

Mosaico 36T	6
Exà	7
Soap	6

MOSAICO 36T, EXÀ, SOAP:
Decoro su rete | Mesh-backed decoration | Dekor auf netz | Décor sur filet | Decoración en red | Декор в сети | 网板背帖装饰件

Positano
1200x2780 / 48"x110"



PRODOTTO ADATTO PER APPLICAZIONE A RIVESTIMENTO E PAVIMENTO (TRAFFICO LEGGERO). | Product suitable for wall and floor applications (light traffic).

KIT FONTAINBLEAU

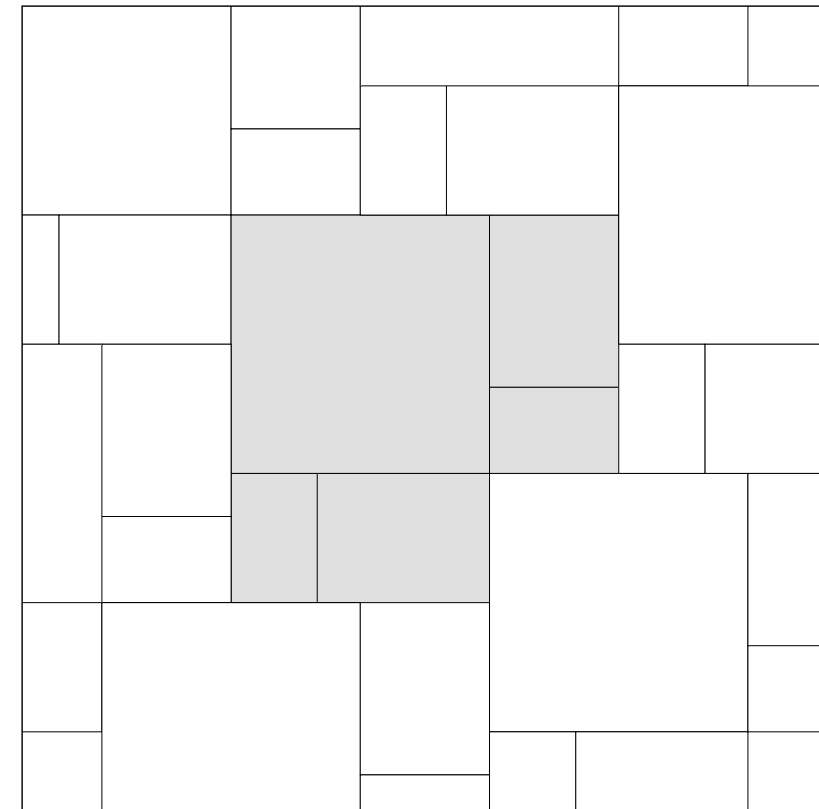

KIT FONTAINBLEAU
(bordo irregolare/irregular edge)
± 9 mm

600x600 / 24"x24" SP
300x400 / 12"x16" SP
300x200 / 12"x8" SP

Colori disponibili | Available colours



COUCHES DJ 01



COMMARIN DJ 02



ROCHEPOT DJ 03



BAZOCHES DJ 04



CORMATIN DJ 05

Pezzi per scatola
Pieces for box

Kit Fontainbleau 1 Kit

600x600 / 24"x24" = 1 pc
300x400 / 12"x16" = 2 pcs
300x200 / 12"x8" = 2 pcs

CARATTERISTICHE TECNICHE

Technical specifications | Technische Eigenschaften | Caractéristiques techniques | Características técnicas | Технические характеристики | 技术特征

STANDARD EN 14411 - G

	CARATTERISTICHE TECNICHE TECHNICAL DATA TECHNISCHE DATEN CARACTERISTIQUES TECHNIQUES CARACTERÍSTICAS TÉCNICAS ТЕХНИЧЕСКИЕ ХАРАКТЕРИСТИКИ 技术特征	NORMA STANDARD NORM NORME NORMA НОРМА 标准	VALORI PRESCRITTI DALLE NORME EN 14411 - G INTERNATIONAL STANDARDS EN 14411 - G INTERNATIONALE NORMWERTE EN 14411 - G VALEURS PREVUES PAR LES NORMES EN 14411 - G VALORES PREVISTOS POR LAS NORMAS EN 14411 - G ПРЕДУСМОТРЕННЫЕ СТАНДАРТОВ EN 14411-G EN 14411 - G标准规定值	*VALORE MEDIO MIRAGE MIRAGE AVERAGE VALUE MIRAGE MITTELWERT VALEURS MOYEN MIRAGE VALOR MEDIO MIRAGE СРЕДНЕЕ ЗНАЧЕНИЕ MIRAGE MIRAGE平均值
	CARATTERISTICHE DIMENSIONALI - SIZE CHARACTERISTICS - MASSEIGENSCHAFTEN DETERMINATION DES CARACTERISTIQUES DIMENSIONNELLES - CARACTERÍSTICAS DIMENSIONALES - РАЗМЕРНЫЕ ХАРАКТЕРИСТИКИ - 尺寸特征			
	LATI SIDES - SEITEN COTES - CANTOS РАЗМЕРЫ СТОРОН - 側邊	EN ISO 10545-2	± 0,3% MAX (± 1,0 mm MAX)	CONFORME COMPLYING
	SPESSORE THICKNESS - DICKE EPAISSEUR - ESPESOR ТОЛЩИНА - 厚度	EN ISO 10545-2	± 5,0% MAX (± 0,5 mm MAX)	CONFORME COMPLYING
	RETTILINEITÀ DEGLI SPIGOLI STRAIGHTNESS OF SIDES - GERADLINIGKEIT DER KANTEN RECTITUDE DES ARETES - RECTITUD DE LOS CANTOS КОСОУГОЛЬНОСТЬ - 边角平直度	EN ISO 10545-2	± 0,3% MAX (± 0,8 mm MAX)	CONFORME COMPLYING
	ORTOGONALITÀ RECTANGULARITY - RECHTWINKLIGKEIT PERPENDICULARITÉ - ORTOGONALIDAD КРИВИЗНА СТОРОН - 直角度	EN ISO 10545-2	± 0,3% MAX (± 1,5 mm MAX)	CONFORME COMPLYING
	PLANARITÀ SURFACE FLATNESS - EBENFLÄCHIGKEIT PLANEITE DE SURFACE - PLANEIDAD КРИВИЗНА ЛИЦЕВОЙ ПОВЕРХНОСТИ - 平整度	EN ISO 10545-2	± 0,4% MAX (± 1,8 mm MAX)	CONFORME COMPLYING
	ASSORBIMENTO D'ACQUA WATER ABSORPTION - WASSERAUFNAHME ABSORPTION D'EAU - ABSORCIÓN DE AGUA ВОДОПОГЛОЩЕНИЕ - 吸水率	EN ISO 10545-3	≤ 0,5%	≤ 0,1%
	RESISTENZA ALLA FLESSIONE FLEXION RESISTANCE - BIEGEFESTIGKEIT RESISTANCE A LA FLEXION - RESISTENCIA A LA FLEXIÓN ПРЕДЕЛ ПРОЧНОСТИ ПРИ ИЗГИБЕ - 抗弯强度	EN ISO 10545-4	S ≥ 700 N (< 7,5 mm) S ≥ 1.300 N (> 7,5 mm) R ≥ 35 N/mm².	±9 mm: S ≥ 2.400 N R ≥ 48 N/mm² ±20 mm: S ≥ 12.500 N R ≥ 48 N/mm²
	RESISTENZA ALL'URTO IMPACT RESISTANCE - STOSSFESTIGKEIT RESISTANCE AUX CHOCS - RESISTENCIA A LOS GOLPES УДАРСТОЙКОСТЬ - 抗冲击强度	EN ISO 10545-5	VALORE DICHIARATO DECLARED VALUE	> 0,80
	RESISTENZA ALL'ABRAZIONE ABRASION RESISTANCE - ABRIEBFESTIGKEIT RESISTANCE A L'ABRASION - RESISTENCIA A LA ABRASIÓN СТОЙКОСТЬ К ИСТИРАНИЮ - 耐磨强度	EN ISO 10545-6	≤ 175 mm³	< 150 mm³
	COEFFICIENTE DI DILATAZIONE TERMICA LINEARE COEFFICIENT OF LINEAR THERMAL-EXPANSION - LINEARER WÄRMEAUDEHNUNGSKOEFFIZIENT COEFFICIENT DE DILATATION THERMIQUE LINEAIRE - COEFICIENTE DE DILATACIÓN TÉRMICA LINEAL КОЭФФИЦИЕНТ ЛИНЕЙНОГО ТЕРМИЧЕСКОГО РАСТЯЖЕНИЯ - 线性热膨胀系数	EN ISO 10545-8	-	α=6,6x10 ⁻⁶ °C ⁻¹
	RESISTENZA AGLI SBALZI TERMICI RESISTANCE TO THERMAL SHOCKS - BESTÄNDIGKEIT GEGEN TEMPERATURSCHWANKUNGEN RESISTANCE AUX CHOCS THERMIQUES - RESISTENCIA A LOS CHOQUES TÉRMICOS СТОЙКОСТЬ К ПЕРЕПАДАМ ТЕМПЕРАТУРЫ - 耐热突变性	EN ISO 10545-9	TEST SUPERATO SECONDO EN ISO 10545-1 PASS ACCORDING EN ISO 10545-1	NESSUN DANNO NO DAMAGE
	RESISTENZA AL GELO FROST RESISTANCE - FROSTBESTÄNDIGKEIT RESISTANCE AU GEL - RESISTENCIA AL HIELO МОРОЗОСТОЙКОСТЬ - 耐冻性	EN ISO 10545-12	TEST SUPERATO SECONDO EN ISO 10545-1 PASS ACCORDING EN ISO 10545-1	NESSUN DANNO NO DAMAGE
	RESISTENZA ALL'ATTACCO CHIMICO RESISTANCE TO CHEMICALS - CHEMIKALIENBESTÄNDIGKEIT RESISTANCE A L'ATTAQUE CHIMIQUE - RESISTENCIA QUÍMICA ХИМИЧЕСКАЯ СТОЙКОСТЬ - 耐化学作用	EN ISO 10545-13	UB MIN.	A LA HA
	RESISTENZA ALLE MACCHIE RESISTANCE TO STAINS - FLECKENBESTÄNDIGKEIT RESISTANCE AUX TACHES - RESISTENCIA A LAS MANCHAS УСТОЙЧИВОСТЬ К ПЯТНООБРАЗОВАНИЮ - 防污性	EN ISO 10545-14	VALORE DICHIARATO DECLARED VALUE	5
	CESSIONE DI PIOMBO E CADMIO LEAD AND CADMIUM DISCHARGE - ABGABE VON BLEI UND CADMIUM PERTE DE PLOMB ET CADMIUM - CESIÓN DE PLOMO Y CADMIO ВЫДЕЛЕНИЕ СВИНЦА И КАДМИЯ - 铅和镉的排放	EN ISO 10545-15	VALORE DICHIARATO DECLARED VALUE	< AL LIMITE DI RILEVAMENTO < THAN INSTRUMENT LIMIT
	SCIVOLOSITÀ SKID RESISTANCE - RUTSCHWERT GLISSANCE - ADHERENCIA СКОЛЬЗКОСТЬ - 防滑性			LAPP SP ST 20 mm
			DM 236/89 BCRA	> 0,40 - - > 0,40 > 0,40
			ANSI A326.3	Wet and Dry - - ≥ 0,42 ≥ 0,55
			AS 4586	- - P2 P5
			DIN 51130	- - R9 R11
			DIN 51097	- - - A+B+C
			UNE 41901	≥ CL1 - CL1 CL3
			BS 7976 sl.96-4S	Wet and Dry - - ≥ 0,36
			BS 7976 sl.55-TRL	Wet and Dry - - ≥ 0,36

Per i certificati specifici, contattare Mirage SpA - For specific certificates, please contact Mirage SpA - Für die speziellen Zertifikate wenden Sie sich bitte an Mirage SpA - Pour les certificats spécifiques, veuillez contacter Mirage SpA
Para los certificados específicos, contactar Mirage SpA - Для сертификатов обращайтесь в компанию Mirage SpA - 关于具体的证书, 请联系Mirage SpA公司



EASYWAY

TACTILE FLOORS for visually impaired and non-sighted users.

3 colours that create the appropriate colour contrasts with the surrounding floor;
4 special patterns to create any route indication.

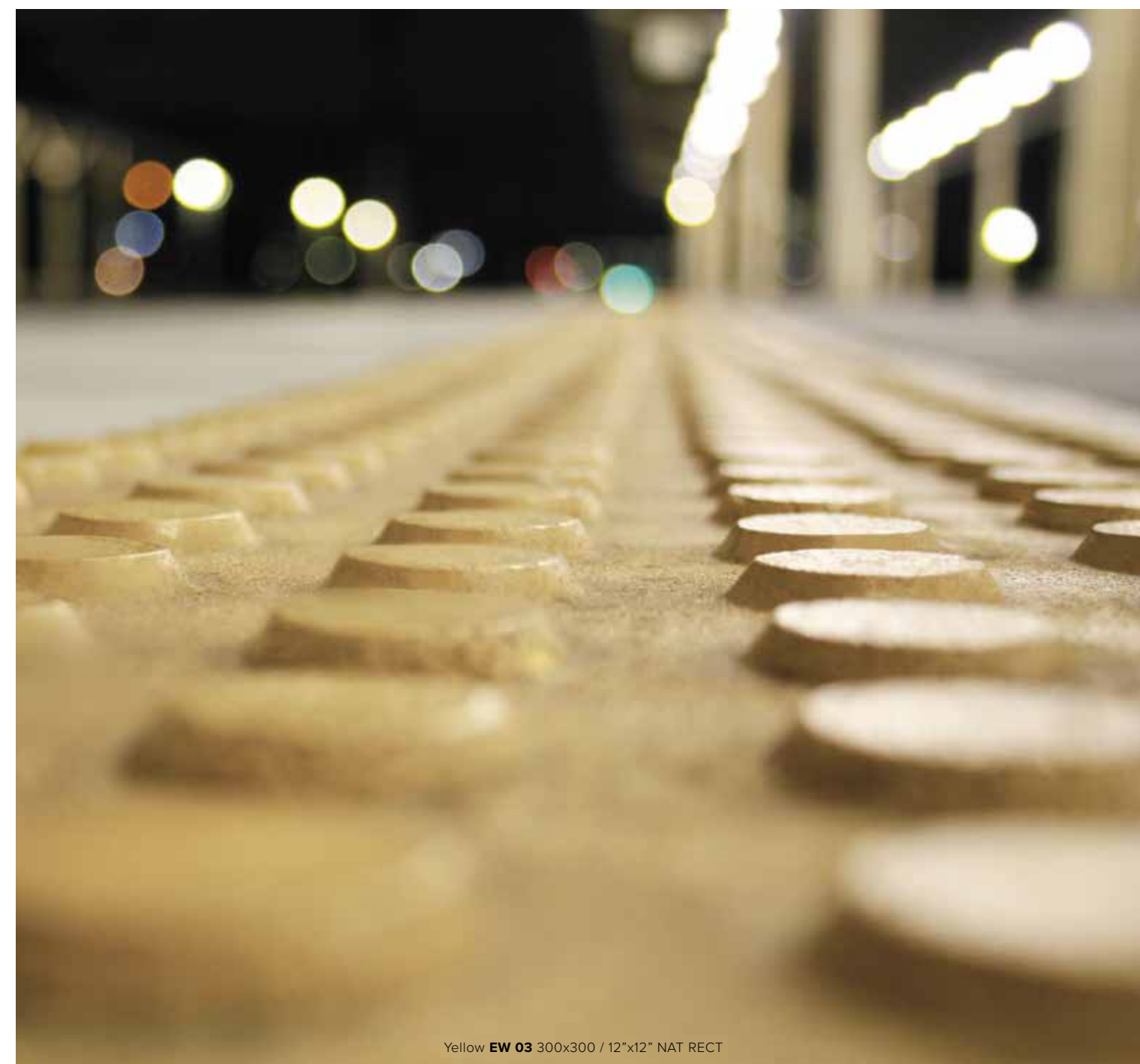

Yellow **EW 03** 300x300 / 12"x12" NAT RECT

DESIGN

COLORI

Colours | Farben | Couleurs | Colores | Цветов | 种颜色

WHITE EW 05

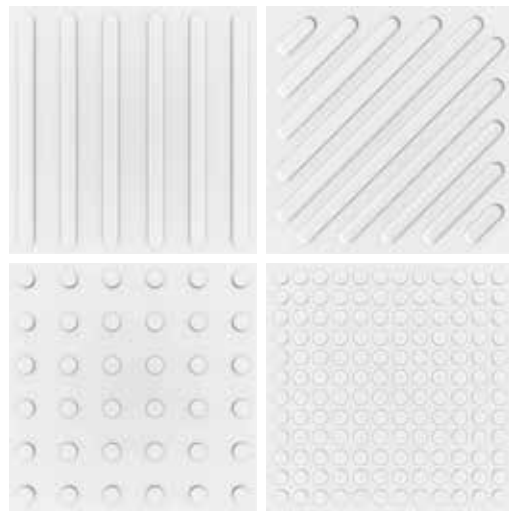

	Formati Nominali Nominal Sizes 300x300 / 12"x12"		Superficie Finish NAT RECT		Spessore mm Thickness mm 9,5
	Stucchi consigliati Recommended grouts				
	KERAKOLL	07			
	MAPEI	111 Grigio Argento			
	LATICRETE	88 Silver Shadow			

YELLOW EW 03

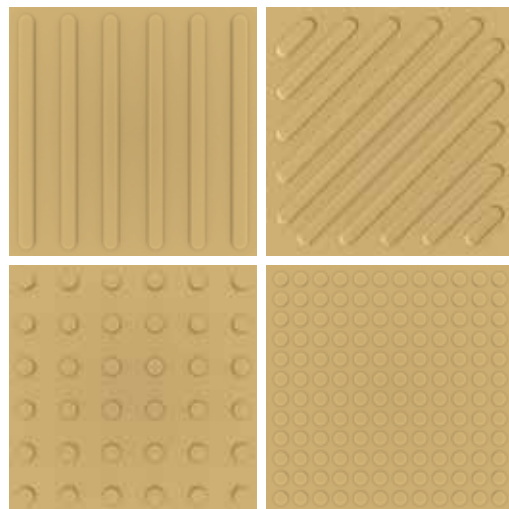

	Formati Nominali Nominal Sizes 300x300 / 12"x12"		Superficie Finish NAT RECT		Spessore mm Thickness mm 9,5
	Stucchi consigliati Recommended grouts				
	KERAKOLL	06			
	MAPEI	110 Manhattan			
	LATICRETE	89 Smoke Grey			

ANTHRACITE EW 11

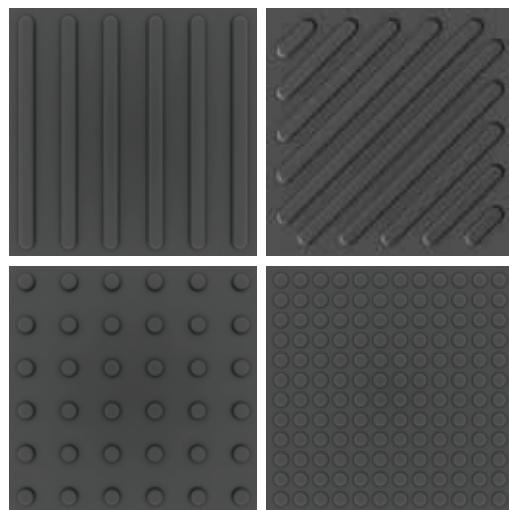

	Formati Nominali Nominal Sizes 300x300 / 12"x12"		Superficie Finish NAT RECT		Spessore mm Thickness mm 9,5
	Stucchi consigliati Recommended grouts				
	KERAKOLL	11			
	MAPEI	114 Antracite			
	LATICRETE	45 Raven			

RIASSUNTIVO FORMATI ED IMBALLI

Summary of sizes and packaging | Übersicht über Formate und Verpackungen | Récapitulatif formats et emballages
Sinóptico de formatos y embalajes | Краткая информация о форматах и упаковках | 规格和包装概述

	GO	STOP	TURN	CROSS
	Formati Nominali Nominal Sizes 300x300 12"x12"	300x300 12"x12"	300x300 12"x12"	300x300 12"x12"
	Tutti i formati sono rettificati. All sizes are rectified.			
	Superficie Finish NAT	NAT	NAT	NAT
	WHITE EW 05			
	YELLOW EW 03			
	ANTHRACITE EW 11			
	Peso lordo per scatola Gross weight per box 22,00	22,00	22,00	22,00
	Pezzi per scatola Pieces for box 12	12	12	12
	mq. scatola sqm. box 1,08	1,08	1,08	1,08
	Scatole / Full pallet boxes / Full pallet 30	30	30	30
	mq. pallet sqm. pallet 32,40	32,40	32,40	32,40

GO

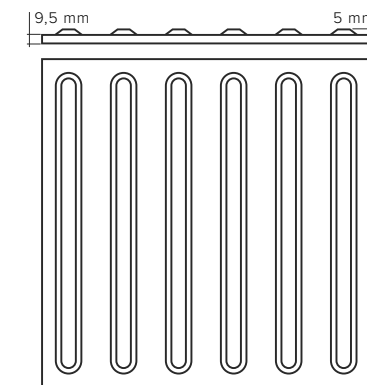

Codice di direzione rettilinea
- costituito da scanalature rettilinee parallele alla direzione di marcia.

Straight direction indicator - composed of grooves that run in a straight line parallel to the direction the user is walking in.

TURN

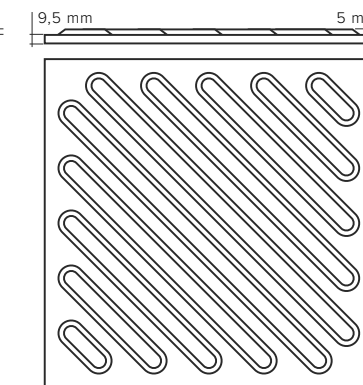

Codice di svolta - costituito da scanalature posizionate in senso diagonale (45°) che indicano la necessità di svoltare.

Turn indicator - composed of grooves placed diagonally (45°) that indicate the need to turn.

STOP

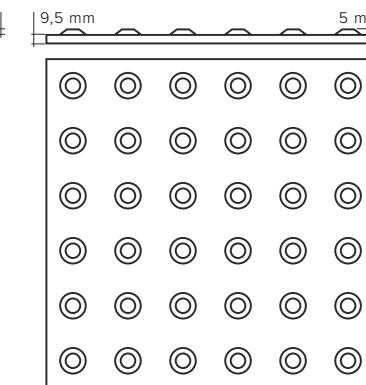

Codice di arresto - costituito da calotte sferiche disposte a reticolo diagonale, in modo da dare una sensazione di netta scomodità, scoraggiandone il calpestio.

Stop indicator - composed of a diagonal network of spherical caps designed to discourage the user from walking over them indicate the need to turn.

CROSS

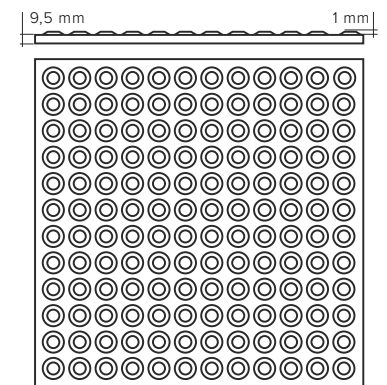

Codice di attenzione - costituito da calotte sferiche molto fitte da applicare in senso perpendicolare in prossimità di una variazione di percorso ed indicante pertanto la necessità di prestare attenzione.

Attention indicator - composed of a close-knit network of spherical caps applied perpendicular to the direction the user is walking in, positioned near the points where a route changes in order to draw the user's attention to the variation.



WALL: Travertino Light **EY 07** Line 1200x2780 / 48"x110" SP RECT
FLOOR: VICEVERSA Alba **VV 07** 1200x1200 / 48"x48" SP RECT

ELYSIAN

Elysian is a real lab for indoor and outdoor applications.

A unique collection of the best-known stones used in architecture, elevated to their highest aesthetic potential.



WALL: NORR Grus **RR 09** 1200x2780 / 48"x110" SP RECT
FLOOR: Saastal **EY 05**
REAR BED WALL: Saastal **EY 05** 300x600 / 12"x12" NAT RECT

COLORI

Colours | Farben | Couleurs | Colores | Цветов | 种颜色

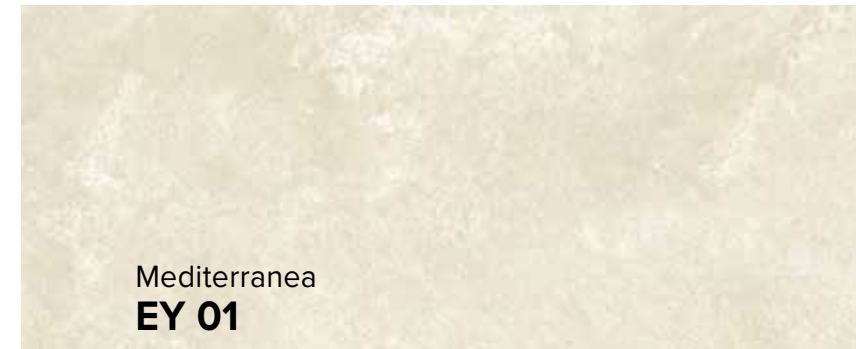

Mediterranea
EY 01



Desert Stone
EY 02

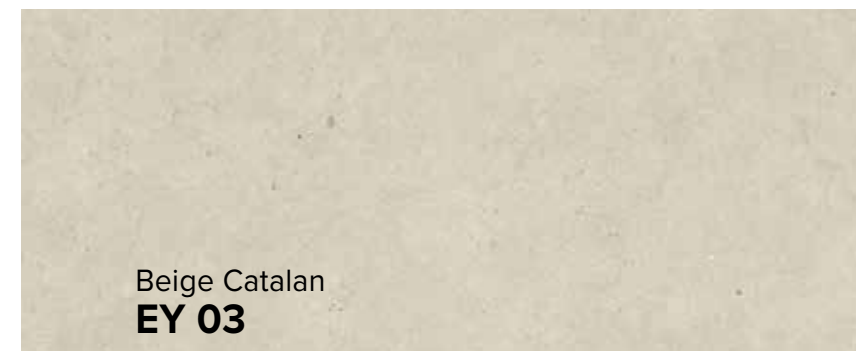

Beige Catalan
EY 03



Gris Catalan
EY 04



Saastal
EY 05



Travertino Light
EY 07



Travertino Dark
EY 08



Gold Catalan
EY 09

WALL: Gris Catalan **EY 04** 1200x2780 / 48"x110" SP RECT
FLOOR: Gris Catalan **EY 04** 1200x1200 / 48"x48" SP RECT
BATHTUB: Gris Catalan **EY 04** SP



WALL: Beige Catalan **EY 03** 1200x2780 / 48"x110" SP RECT
FLOOR: Beige Catalan **EY 03** 800x800 / 31½"x31½" SP RECT
TABLE TOP: WANDERLUST Onice Brown **WA 03** LUC



WALL & CABINET: Travertino Light **EY 07** 1200x2780 / 48"x110" SP RECT
FLOOR: Travertino Light **EY 07** 600x1200 / 24"x48" NAT RECT
FURNITURE: BATHMOOD Joy **EY 07** SP + **GC 07** SP + BATHMOOD Horizontal Bliss Mirror **GC 07** SP

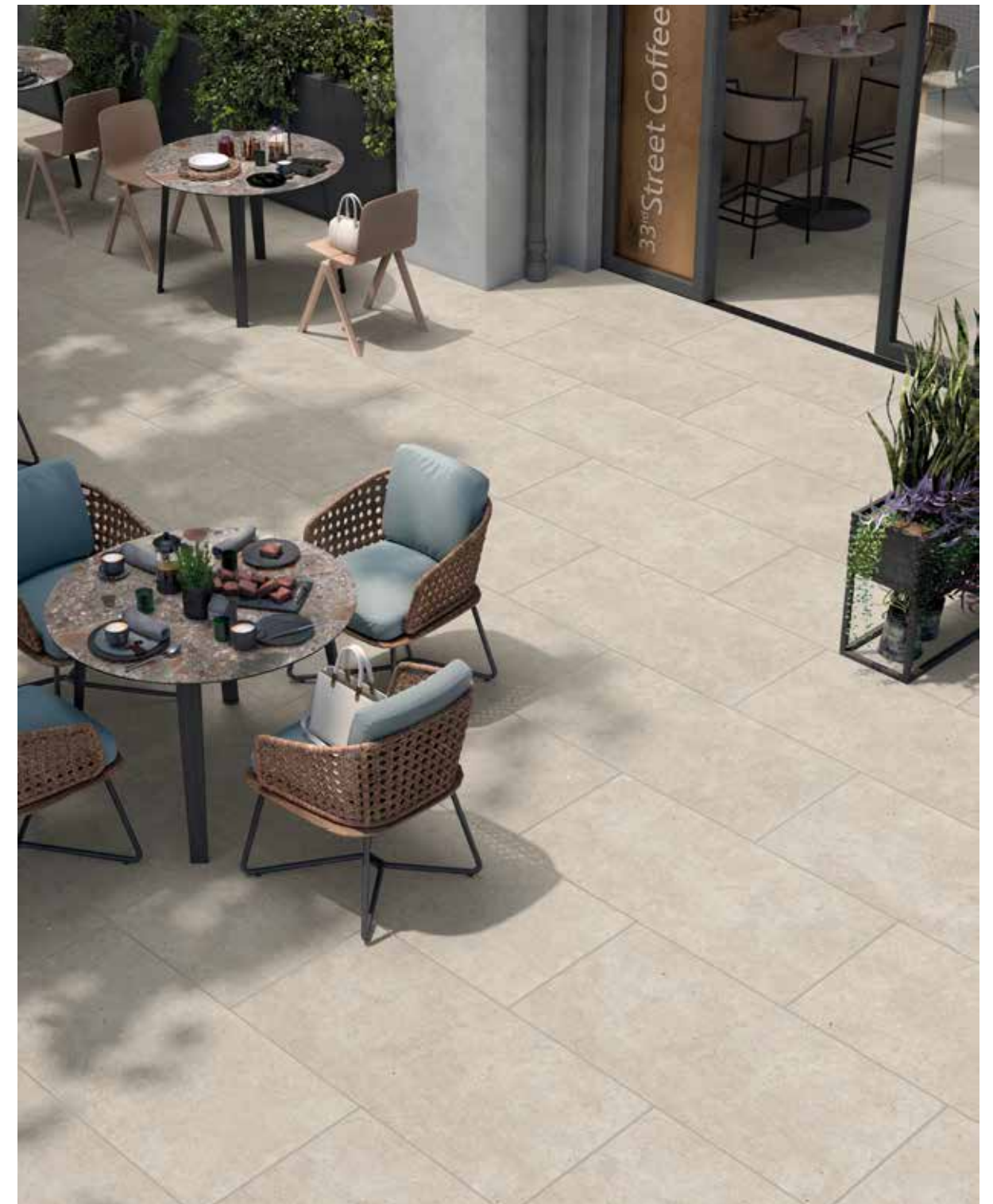

FLOOR: Beige Catalan **EY 03** 600x1200 / 24"x48" ST RECT

COLORI

Colours | Farben | Couleurs | Colores | Цветов | 种颜色

MEDITERRANEA **EY 01**



Formati Nominali Nominal Sizes	Superficie Finish	Spessore mm Thickness mm
300x600 / 12"x24"	NAT / SP RECT	9
600x600 / 24"x24"	NAT / SP RECT	9
600x1200 / 24"x48"	NAT / SP / ST RECT	9
800x800 / 31½"x31½"	SP RECT	9
800x1600 / 31½"x63"	SP RECT	9
1200x1200 / 48"x48"	SP / ST RECT	9
600x1200 / 24"x48"	SP RECT	6
1200x2780 / 48"x110"	SP RECT	6
Line 1200x2780 / 48"x110"	SP RECT	6
Arrow 1200x2780 / 48"x110"	SP RECT	6
1620x3240 / 63¾"x127½"	SP NOT RECT	12
600x600 / 24"x24"	ST RECT	20
600x1200 / 24"x48"	ST RECT	20
800x800 / 31½"x31½"	ST RECT	20

Stucchi consigliati Recommended grouts		
KERAKOLL	20	
MAPEI	111 Grigio Argento	
LATICRETE	85 Almond	

DESERT STONE **EY 02**



Formati Nominali Nominal Sizes	Superficie Finish	Spessore mm Thickness mm
300x600 / 12"x24"	NAT / SP RECT	9
600x600 / 24"x24"	NAT / SP RECT	9
600x1200 / 24"x48"	NAT / SP / ST RECT	9
800x800 / 31½"x31½"	SP RECT	9
800x1600 / 31½"x63"	SP RECT	9
1200x1200 / 48"x48"	SP / ST RECT	9
600x1200 / 24"x48"	SP RECT	6
1200x2780 / 48"x110"	SP RECT	6
Line 1200x2780 / 48"x110"	SP RECT	6
Arrow 1200x2780 / 48"x110"	SP RECT	6
1620x3240 / 63¾"x127½"	SP NOT RECT	12
600x600 / 24"x24"	ST RECT	20
600x1200 / 24"x48"	ST RECT	20
800x800 / 31½"x31½"	ST RECT	20
1200x1200 / 48"x48"	ST RECT	20

Stucchi consigliati Recommended grouts		
KERAKOLL	43	
MAPEI	110 Manhattan	
LATICRETE	85 Almond	

BEIGE CATALAN **EY 03**



Formati Nominali Nominal Sizes	Superficie Finish	Spessore mm Thickness mm
300x600 / 12"x24"	NAT / SP RECT	9
600x600 / 24"x24"	NAT / SP RECT	9
600x1200 / 24"x48"	NAT / SP / ST RECT	9
800x800 / 31½"x31½"	SP RECT	9
1200x1200 / 48"x48"	SP / ST RECT	9
600x1200 / 24"x48"	SP RECT	6
1200x2780 / 48"x110"	SP RECT	6
1620x3240 / 63¾"x127½"	SP NOT RECT	12
600x600 / 24"x24"	ST RECT	20
600x1200 / 24"x48"	ST RECT	20
800x800 / 31½"x31½"	ST RECT	20

Stucchi consigliati Recommended grouts		
KERAKOLL	43	
MAPEI	111 Grigio Argento	
LATICRETE	90 Light Pewter	

GRIS CATALAN **EY 04**



Formati Nominali Nominal Sizes	Superficie Finish	Spessore mm Thickness mm
300x600 / 12"x24"	NAT RECT	9
600x600 / 24"x24"	NAT RECT	9
600x1200 / 24"x48"	NAT / ST RECT	9
800x800 / 31½"x31½"	SP RECT	9
1200x1200 / 48"x48"	SP / ST RECT	9
1200x2780 / 48"x110"	SP RECT	6
600x600 / 24"x24"	ST RECT	20
600x1200 / 24"x48"	ST RECT	20
800x800 / 31½"x31½"	ST RECT	20

Stucchi consigliati Recommended grouts		
KERAKOLL	08	
MAPEI	112 Grigio Medio	
LATICRETE	78 Sterling Silver	

SAASTAL **EY 05**



Formati Nominali Nominal Sizes	Superficie Finish	Spessore mm Thickness mm
300x600 / 12"x24"	NAT RECT	9
600x600 / 24"x24"	NAT RECT	9
600x1200 / 24"x48"	NAT / ST RECT	9
800x800 / 31½"x31½"	SP RECT	9
1200x1200 / 48"x48"	SP RECT	9
600x600 / 24"x24"	ST RECT	20
600x1200 / 24"x48"	ST RECT	20
800x800 / 31½"x31½"	ST RECT	20

Stucchi consigliati Recommended grouts		
KERAKOLL	08	
MAPEI	113 Grigio Cemento	
LATICRETE	78 Sterling Silver	

TRAVERTINO LIGHT **EY 07**



Formati Nominali Nominal Sizes	Superficie Finish	Spessore mm Thickness mm
300x600 / 12"x24"	NAT / SP RECT	9
600x600 / 24"x24"	NAT / SP RECT	9
600x1200 / 24"x48"	NAT / SP / ST RECT	9
800x800 / 31½"x31½"	SP RECT	9
800x1600 / 31½"x63"	SP RECT	9
1200x1200 / 48"x48"	SP / ST RECT	9
600x1200 / 24"x48"	SP RECT	6
1200x2780 / 48"x110"	SP RECT	6
Line 1200x2780 / 48"x110"	SP RECT	6
1620x3240 / 63¾"x127½"	SP NOT RECT	12
300x1200 / 12"x48"	ST RECT	20
600x1200 / 24"x48"	ST RECT	20

Stucchi consigliati Recommended grouts		
KERAKOLL	43	
MAPEI	111 Grigio Argento	
LATICRETE	85 Almond	

COLORI

Colours | Farben | Couleurs | Colores | Цветов | 种颜色

TRAVERTINO DARK EY 08



Formati Nominali Nominal Sizes		Superficie Finish	Spessore mm Thickness mm
300x600 / 12"x24"		NAT RECT	9
600x600 / 24"x24"		NAT RECT	9
600x1200 / 24"x48"		NAT RECT	9
800x800 / 31½"x31½"		SP RECT	9
1200x1200 / 48"x48"		SP RECT	9
1200x2780 / 48"x110"		SP RECT	6
C 600x1200 / 24"x48"		ST RECT	20

Stucchi consigliati Recommended grouts		
KERAKOLL	08	
MAPEI	112 Grigio Medio	
LATICRETE	78 Sterling Silver	

GOLD CATALAN EY 09



Formati Nominali Nominal Sizes		Superficie Finish	Spessore mm Thickness mm
300x600 / 12"x24"		NAT / SP RECT	9
600x600 / 24"x24"		NAT / SP RECT	9
600x1200 / 24"x48"		NAT / SP / ST RECT	9
800x800 / 31½"x31½"		SP RECT	9
1200x1200 / 48"x48"		SP / ST RECT	9
600x1200 / 24"x48"		SP RECT	6
1200x2780 / 48"x110"		SP RECT	6
C 600x600 / 24"x24"		ST RECT	20
C 600x1200 / 24"x48"		ST RECT	20
C 800x800 / 31½"x31½"		ST RECT	20
C 1200x1200 / 48"x48"		ST RECT	20

Stucchi consigliati Recommended grouts		
KERAKOLL	43	
MAPEI	132 Beige 2000	
LATICRETE	23 Antique White	



WALL: Mediterranea EY 01 Arrow 1200x2780 / 48"x110" SP RECT
 FLOOR: CLAY Trust CL 07 1200x1200 / 48"x48" SP RECT
 TABLE: JOLIE Calacatta Select JL 02 LUC

RIASSUNTIVO FORMATI ED IMBALLI

Summary of sizes and packaging | Übersicht über Formate und Verpackungen | Récapitulatif formats et emballages
Sinóptico de formatos y embalajes | Краткая информация о форматах и упаковках | 规格和包装概述

9 mm												
Formati Nominali Nominal Sizes	300x600 12"x24"	600x600 24"x24"	600x1200 24"x48"	800x800 31½"x31½"	800x1600 31½"x63"	1200x1200 48"x48"						
Tutti i formati sono rettificati. All sizes are rectified.												
Superficie Finish	NAT	SP	NAT	SP	NAT	SP	ST	SP	SP	SP	ST	ST
MEDITERRANEA EY 01	V2	■	■	■	■	■	■	■	■	■	■	■
DESERT STONE EY 02	V2	■	■	■	■	■	■	■	■	■	■	■
BEIGE CATALAN EY 03	V2	■	■	■	■	■	■	■	-	■	■	■
GRIS CATALAN EY 04	V2	■	-	■	-	■	-	■	-	■	■	■
SAASTAL EY 05	V2	■	-	■	-	■	-	■	-	■	-	-
TRAVERTINO LIGHT EY 07	V2	■	■	■	■	■	■	■	■	■	■	■
TRAVERTINO DARK EY 08	V2	■	-	■	-	■	-	■	-	■	-	-
GOLD CATALAN EY 09	V2	■	■	■	■	■	■	■	-	■	■	■
Peso lordo per scatola Gross weight per box	25,58	25,58	22,13	22,13	29,56	29,56	29,19	27,36	55,12	61,56	61,56	
Pezzi per scatola Pieces for box	7	7	3	3	2	2	2	2	2	2	2	
mq. scatola sqm. box	1,26	1,23	1,08	1,08	1,44	1,44	1,44	1,28	2,56	2,88	2,88	
Scatole / Full pallet boxes / Full pallet	40	40	40	40	35	35	35	48	16	20	20	
mq. pallet sqm. pallet	50,40	50,40	43,20	43,20	50,40	50,40	50,40	61,44	40,96	57,60	57,60	

TUTTI I FORMATI IN 9 MM NAT SONO REALIZZATI CON LA TECNOLOGIA PERFORMA.
All 9 mm NAT sizes are produced with PERFORMA technology.

6 mm						12 mm					
Formati Nominali Nominal Sizes	600x1200 24"x48"	1200x2780 48"x110"	Line 1200x2780 48"x110"	Arrow 1200x2780 48"x110"	1620x3240 63¾"x127½"						
Tutti i formati sono rettificati, eccetto il formato 1620x3240. All sizes except 1620x3240 are rectified.											
Superficie Finish	SP	SP	SP	SP	SP						
MEDITERRANEA EY 01	V2	■	■	■	■						
DESERT STONE EY 02	V2	■	■	■	■						
BEIGE CATALAN EY 03	V2	■	■	-	-						
GRIS CATALAN EY 04	V2	-	■	-	-						
SAASTAL EY 05	V2	-	-	-	-						
TRAVERTINO LIGHT EY 07	V2	■	■	■	-						
TRAVERTINO DARK EY 08	V2	-	■	-	-						
GOLD CATALAN EY 09	V2	■	■	-	-						
Peso lordo per scatola Gross weight per box	-										
Pezzi per scatola Pieces for box	3										
mq. scatola sqm. box	2,16	Please refer to page 588	Please refer to page 588	Please refer to page 588	Please refer to page 588						
Scatole / Full pallet boxes / Full pallet	24										
mq. pallet sqm. pallet	51,84										

Per tutti i grandi formati è possibile prevedere, su richiesta, e con un lotto minimo l'applicazione di una stuoia in fibra di vetro.
For big sizes, a fibreglass mat can be applied on request, with a minimum production batch.

ACCORGIMENTI SPECIFICI PER L'APPLICAZIONE DELLE GRANDI LASTRE IN 6 MM DI SPESSORE: p. 582 | Precautions for 6mm big slabs applications: page 582 | spezifische Anweisungen zur Nutzung der Grossformate in 6mm: seite 582 | Precauciones específicas para la aplicación de las grandes placas en 6 mm de espesor: page 582 | Precautions spécifiques pour la pose des grandes plaques en 6mm d'épaisseur: página 582 | специальные предосторожности для укладки больших плит толщиной 6 мм : страница 582

RACCOMANDAZIONI PER UTILIZZO E CURA DELLE LASTRE COUNTERTOPS p. 583 | How to use and take good care of the COUNTERTOPS slabs p. 583 | Tipps für den Einsatz und die Pflege der Platten COUNTERTOPS p. 583 | Recommandations pour l'utilisation et le soin des plaques COUNTERTOPS p.583 | Recomendaciones para el uso y cuidado de las placas COUNTERTOPS p. 583 | Рекомендации по использованию и уходу за плитami COUNTERTOPS p.583 | 规格的COUNTERTOPS系列陶瓷板的使用和护理建议 583

20 mm							
Formati Nominali Nominal Sizes	600x600 24"x24"	800x800 31½"x31½"	300x1200 12"x48"	600x1200 24"x48"	1200x1200 48"x48"		
Tutti i formati sono rettificati. All sizes are rectified.							
Superficie Finish	ST	ST	ST	ST	ST		
MEDITERRANEA EY 01	V2	■	-	■	-		
DESERT STONE EY 02	V2	■	-	■	■		
BEIGE CATALAN EY 03	V2	■	-	■	-		
GRIS CATALAN EY 04	V2	■	-	■	-		
SAASTAL EY 05	V2	■	-	■	-		
TRAVERTINO LIGHT EY 07	V2	-	-	■	■		
TRAVERTINO DARK EY 08	V2	-	-	-	■		
GOLD CATALAN EY 09	V2	■	-	■	■		
Peso lordo per scatola Gross weight per box	31,14	28,50	32,00	32,00		Please refer to page 588	
Pezzi per scatola Pieces for box	2	1	2	1			
mq. scatola sqm. box	0,72	0,64	0,72	0,72			
Scatole / Full pallet boxes / Full pallet	30	42	36	35			
mq. pallet sqm. pallet	21,60	26,88	25,92	25,20			

MY NOTES

.....

.....

.....

.....

.....





Maggiori informazioni
More information





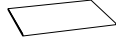

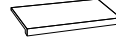
NAT: Naturale | Natural | Natur/unpoliert | Naturelle | Natural | Натуральный | 天然
SP: Strutturata | Structured | Strukturiert | Structuré | Estructurado | Труктурированный | 结构
SP: Spazzolata

PEZZI SPECIALI

Special pieces | Sonderstücke | Pièces spéciales | Piezas especiales | специальные изделия | 特殊件

	 Gradino A*	 Gradino A*	 Gradino A*	 Gradino B	 Gradino B	 Gradino B
Pezzi speciali Special pieces	300x600 12"x24"	330x800 13 1/8"x31 1/2"	330x1200 13 1/8"x48"	330x600 13 1/8"x24"	330x800 13 1/8"x31 1/2"	330x1200 13 1/8"x48"
Superficie Finish	NAT	SP	NAT	NAT	SP	NAT
MEDITERRANEA EY 01	■	■	■	■	■	■
DESERT STONE EY 02	■	■	■	■	■	■
BEIGE CATALAN EY 03	■	■	■	■	■	■
GRIS CATALAN EY 04	■	■	■	■	■	■
SAASTAL EY 05	■	■	■	■	■	■
TRAVERTINO LIGHT EY 07	■	■	■	■	■	■
TRAVERTINO DARK EY 08	■	■	■	■	■	■
GOLD CATALAN EY 09	■	■	■	■	■	■
Pezzi per scatola Pieces for box	7	7	4	4	4	2

* Finitura a becco di civetta | One-round edge shaping | Ausführung mit Eckabrundung | Façonnage à bord rond | Acabado canto romo | Плитка с завалом | 鹰嘴边缘处理

	 Gradino B ang.	 Battiscopa*	 Gradino G*	 Gradino G*
Pezzi speciali Special pieces	330x330 13 1/8"x13 1/8"	72x600 2 7/8"x24"	72x800 2 7/8"x31 1/2"	300x600 12"x24"
Superficie Finish	NAT	SP	NAT	SP
MEDITERRANEA EY 01	■	■	■	■
DESERT STONE EY 02	■	■	■	■
BEIGE CATALAN EY 03	■	■	■	■
GRIS CATALAN EY 04	■	■	■	■
SAASTAL EY 05	■	■	■	■
TRAVERTINO LIGHT EY 07	■	■	■	■
TRAVERTINO DARK EY 08	■	■	■	■
GOLD CATALAN EY 09	■	■	■	■
Pezzi per scatola Pieces for box	4	4	10	7

DECORI

Decors | Dekore | Decors | Decoros | Декоры | 装饰砖

 **Mosaico 36T NAT**
300x300 / 12"x12"
Tessere 48x48 / 2"x2"

			
MEDITERRANEA EY 01	DESERT STONE EY 02	BEIGE CATALAN EY 03	GRIS CATALAN EY 04
			
SAASTAL EY 05	TRAVERTINO LIGHT EY 07	TRAVERTINO DARK EY 08	GOLD CATALAN EY 09

 **Layer NAT**
300x600 / 12"x24"

	
MEDITERRANEA EY 01	DESERT STONE EY 02
	
BEIGE CATALAN EY 03	GRIS CATALAN EY 04
	
SAASTAL EY 05	TRAVERTINO LIGHT EY 07
	
TRAVERTINO DARK EY 08	GOLD CATALAN EY 09

NAT: Naturale | Natural | Natur/unpoliert | Naturelle | Natural | Натуральный | 天然
ST: Strutturata | Structured | Strukturiert | Structuré | Estructurado | Труктурированный | 结构
SP: Spazzolata

 **Pezzi per scatola**
Pieces for box

Mosaico 36T	6
Layer	4

MOSAICO 36T, LAYER:
Decoro su rete | Mesh-backed decoration | Dekor auf netz | Décor sur filet | Decoración en red | Декор в сетку | 网板背帖装饰件

LINE and ARROW

Una nuova proposta decorativa che esalta le superfici, per un effetto dalla profondità sorprendente.

A new decorative effect that brings out the astonishing depth of our surfaces.

Line SP RECT
1200x2780 / 48"x110"



MEDITERRANEA **EY 01**

Line SP RECT
1200x2780 / 48"x110"



DESERT STONE **EY 02**

Line SP RECT
1200x2780 / 48"x110"



TRAVERTINO LIGHT **EY 07**

Arrow SP RECT
1200x2780 / 48"x110"



MEDITERRANEA **EY 01**

Arrow SP RECT
1200x2780 / 48"x110"



DESERT STONE **EY 02**

CARATTERISTICHE TECNICHE

Technical specifications | Technische Eigenschaften | Caractéristiques techniques | Características técnicas | Технические характеристики | 技术特征

STANDARD EN 14411 - G

CARATTERISTICHE TECNICHE TECHNICAL DATA TECHNISCHE DATEN CARACTERISTIQUES TECHNIQUES CARACTERÍSTICAS TÉCNICAS ТЕХНИЧЕСКИЕ ХАРАКТЕРИСТИКИ 技术特征	NORMA STANDARD NORM NORME NORMA ЗНАЧЕНИЯ 标准	VALORI PRESCRITTI DALLE NORME EN 14411 - G INTERNATIONAL STANDARDS EN 14411 - G INTERNATIONALE NORMWERTE EN 14411 - G VALEURS PREVUES PAR LES NORMES EN 14411 - G VALORES PREVISTOS POR LAS NORMAS EN 14411 - G ПРЕДУСМОТРЕННЫЕ СТАНДАРТОМ EN 14411-G EN 14411 - G标准规定值	*VALORE MEDIO MIRAGE MIRAGE AVERAGE VALUE MIRAGE MITTELWERT VALEUR MOYEN MIRAGE VALOR MEDIO MIRAGE СРЕДНЕЕ ЗНАЧЕНИЕ MIRAGE MIRAGE平均值
CARATTERISTICHE DIMENSIONALI - SIZE CHARACTERISTICS - MASSEIGENSCHAFTEN DETERMINATION DES CARACTERISTIQUES DIMENSIONNELLES - CARACTERÍSTICAS DIMENSIONALES - РАЗМЕРНЫЕ ХАРАКТЕРИСТИКИ - 尺寸特征			
LATI SIDES - SEITEN COTES - CANTOS РАЗМЕРЫ СТОРОН - 侧边	EN ISO 10545-2	± 0,3% MAX (± 1,0 mm MAX)	CONFORME COMPLYING
SPESSORE THICKNESS - DICKE ÉPAISSEUR - ESPESOR ТОЛЩИНА - 厚度	EN ISO 10545-2	± 5,0% MAX (± 0,5 mm MAX)	CONFORME COMPLYING
RETTILINEITÀ DEGLI SPIGOLI STRAIGHTNESS OF SIDES - GERADLINIGKEIT DER KANTEN RECTITUDE DES ARETES - RECTITUD DE LOS CANTOS КОСОУГОЛЬНОСТЬ - 边角平直度	EN ISO 10545-2	± 0,3% MAX (± 0,8 mm MAX)	CONFORME COMPLYING
ORTOGONALITÀ RECTANGULARITY - RECHTWINKLIGKEIT PERPENDICULARITÉ - ORTOGONALIDAD КРИВИЗНА СТОРОН - 直角度	EN ISO 10545-2	± 0,3% MAX (± 1,5 mm MAX)	CONFORME COMPLYING
PLANARITÀ SURFACE FLATNESS - EBENFLÄCHIGKEIT PLANEITE DE SURFACE - PLANEIDAD КРИВИЗНА ЛИЦЕВОЙ ПОВЕРХНОСТИ - 平整度	EN ISO 10545-2	± 0,4% MAX (± 1,8 mm MAX)	CONFORME COMPLYING
ASSORBIMENTO D'ACQUA WATER ABSORPTION - WASSERAUFNAHME ABSORPTION D'EAU - ABSORCIÓN DE AGUA ВОДОПОГЛОЩЕНИЕ - 吸水率	EN ISO 10545-3	≤ 0,5%	≤ 0,1%
RESISTENZA ALLA FLESSIONE FLEXION RESISTANCE - BIEGEFESTIGKEIT RESISTANCE A LA FLEXION - RESISTENCIA A LA FLEXIÓN ПРЕДЕЛ ПРОЧНОСТИ ПРИ ИЗГИБЕ - 抗弯强度	EN ISO 10545-4	S ≥ 700 N (< 7,5 mm) S ≥ 1.300 N (> 7,5 mm) R ≥ 35 N/mm ² .	±6 mm: S≥1100N R≥45N/mm ² ±9 mm: S≥2.400N R≥48N/mm ² ±20 mm: S≥12.500N R≥48N/mm ²
RESISTENZA ALL'URTO IMPACT RESISTANCE - STOSSFESTIGKEIT RESISTANCE AUX CHOCS - RESISTENCIA A LOS GOLPES УДАРСТОЙКОСТЬ - 抗冲击强度	EN ISO 10545-5	VALORE DICHIARATO DECLARED VALUE	> 0,80
RESISTENZA ALL'ABRAZIONE ABRASION RESISTANCE - ABRIEBFESTIGKEIT RESISTANCE A L'ABRASION - RESISTENCIA A LA ABRASIÓN СТОЙКОСТЬ К ИСТИРАНИЮ - 耐磨强度	EN ISO 10545-6	≤ 175 mm ³	< 150 mm ³
COEFFICIENTE DI DILATAZIONE TERMICA LINEARE COEFFICIENT OF LINEAR THERMAL-EXPANSION - LINEARER WÄRMEAUDEHNUNGSKOEFFIZIENT COEFFICIENT DE DILATATION THERMIQUE LINEAIRE - COEFFICIENTE DE DILATACIÓN TÉRMICA LINEAL КОЭФФИЦИЕНТ ЛИНЕЙНОГО ТЕРМИЧЕСКОГО РАСТЯЖЕНИЯ - 线性热膨胀系数	EN ISO 10545-8	—	α=6,6x10 ⁻⁶ °C ⁻¹
RESISTENZA AGLI SBALZI TERMICI RESISTANCE TO THERMAL SHOCKS - BESTÄNDIGKEIT GEGEN TEMPERATURSCHWANKUNGEN RESISTANCE AUX CHOCS THERMIQUES - RESISTENCIA A LOS CHOQUES TÉRMICOS СТОЙКОСТЬ К ПЕРЕПАДАМ ТЕМПЕРАТУРЫ - 耐热突变性	EN ISO 10545-9	TEST SUPERATO SECONDO EN ISO 10545-1 PASS ACCORDING EN ISO 10545-1	NESSUN DANNO NO DAMAGE
RESISTENZA AL GELO FROST RESISTANCE - FROSTBESTÄNDIGKEIT RESISTANCE AU GEL - RESISTENCIA AL HIELO МОРОЗОСТОЙКОСТЬ - 耐冻性	EN ISO 10545-12	TEST SUPERATO SECONDO EN ISO 10545-1 PASS ACCORDING EN ISO 10545-1	NESSUN DANNO NO DAMAGE
RESISTENZA ALL'ATTACCO CHIMICO RESISTANCE TO CHEMICALS - CHEMIKALIENBESTÄNDIGKEIT RESISTANCE A L'ATTAQUE CHIMIQUE - RESISTENCIA QUÍMICA ХИМИЧЕСКАЯ СТОЙКОСТЬ - 耐化学药品作用	EN ISO 10545-13	B MIN.	A LA HA
RESISTENZA ALLE MACCHIE RESISTANCE TO STAINS - FLECKENBESTÄNDIGKEIT RESISTANCE AUX TACHES - RESISTENCIA A LAS MANCHAS УСТОЙЧИВОСТЬ К ПЯТНООБРАЗОВАНИЮ - 防污性	EN ISO 10545-14	VALORE DICHIARATO DECLARED VALUE	5
CESSIONE DI PIOMBO E CADMIO LEAD AND CADMIUM DISCHARGE - ABGABE VON BLEI UND CADMIUM PERTE DE PLOMB ET CADMIUM - CESIÓN DE PLOMO Y CADMIO ВЫДЕЛЕНИЕ СВИНЦА И КАДМИЯ - 铅和镉的排放	EN ISO 10545-15	VALORE DICHIARATO DECLARED VALUE	< AL LIMITE DI RILEVAMENTO < THAN INSTRUMENT LIMIT
			NAT ST SP ST 20mm
	DM 236/89 BCRA	> 0,40	> 0,40 > 0,40 > 0,40 > 0,40
	ANSI A326.3	Wet and Dry	≥ 0,42 ≥ 0,55 ≥ 0,42 ≥ 0,55
	AS 4586	-	P3 - P2 -
	DIN 51130	-	R10 R11 R9 R11
	DIN 51097	-	A+B A+B+C - A+B+C
	UNE 41901	≥ CL1	CL2 CL3 CL1 CL3
	BS 7976 sl.96-4S	Wet and Dry	≥ 0,36 ≥ 0,36 - ≥ 0,36
	BS 7976 sl.55-TRL	Wet and Dry	≥ 0,36 ≥ 0,36 - ≥ 0,36

Per i certificati specifici, contattare Mirage SpA - For specific certificates, please contact Mirage SpA - Für die speziellen Zertifikate wenden Sie sich bitte an Mirage SpA - Pour les certificats spécifiques, veuillez contacter Mirage SpA
Para los certificados específicos, contactar Mirage SpA - Для сертификатов обращайтесь в компанию Mirage SpA - 关于具体的证书, 请联系Mirage SpA公司



WALL: Travertino Light **EY 07** 1200x2780 / 48"x110" SP RECT
FLOOR: Travertino Light Cross **EY 13** 1200x1200 / 48"x48" SP RECT
WASHBASIN: BATHMOOD Delight **EY 07** SP + BATHMOOD Vertical Bliss Mirror **EY 07** SP

ELYSIAN TRAVERTINI

A versatile collection that satisfies multiple stylistic, architectural and interior design needs.

8 colours ranging from beige to gray, for a timeless aesthetic.



WALL: Travertino Pearly **EY 10** 1200x2780 / 48"x110" SP RECT
FLOOR: Travertino Pearly Cross **EY 12** 800x800 / 31½"x31½" SP RECT

COLORI

Colours | Farben | Couleurs | Colores | Цветов | 种颜色

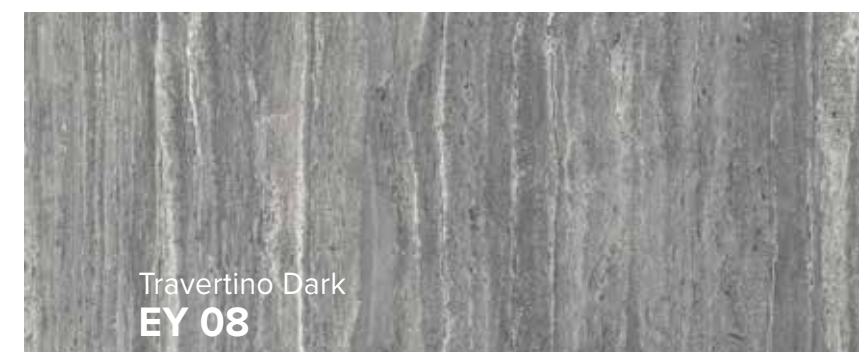
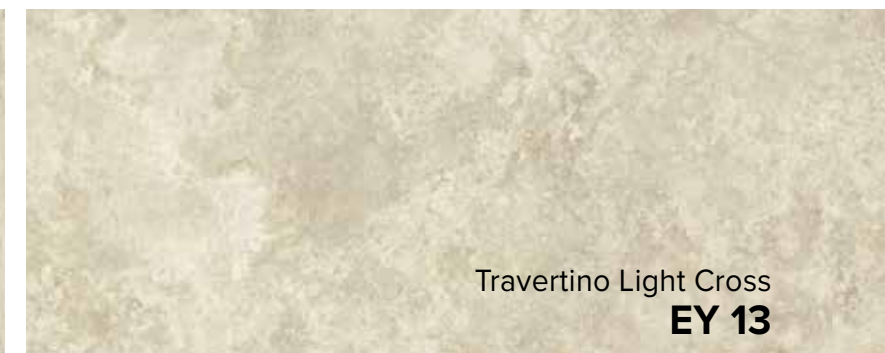

WALL: Travertino Misty **EY 11** 1200x2780 / 48"x110" SP RECT
FLOOR: Travertino Misty Cross **EY 14** 800x800 / 31½"x31½" SP RECT



INDOOR FLOOR: Travertino Misty Cross **EY 14** 600x1200 / 24"x48" SP RECT
OUTDOOR FLOOR: Travertino Misty Cross **EY 14** 600x600 / 24"x24" ST RECT EVO_2/E" ± 20 mm
EVO_LIVING TABLE: Eden 90x90 - Table Top ELYSIAN Desert Stone **EY 02** SP



WALL: Line Travertino Light **EY 07** 1200x2780 / 48"x110" SP RECT
FLOOR: CLAY Calm **CL 01** 1200x1200 / 48"x48" SP RECT



FLOOR: Travertino Rustic Cross **EY 15** 600x600 / 24"x24" ST RECT EVO_2/E" 20 mm
EVO_LIVING TABLE: Eden 100x200 - Table Top ELYSIAN Desert Stone **EY 02** SP

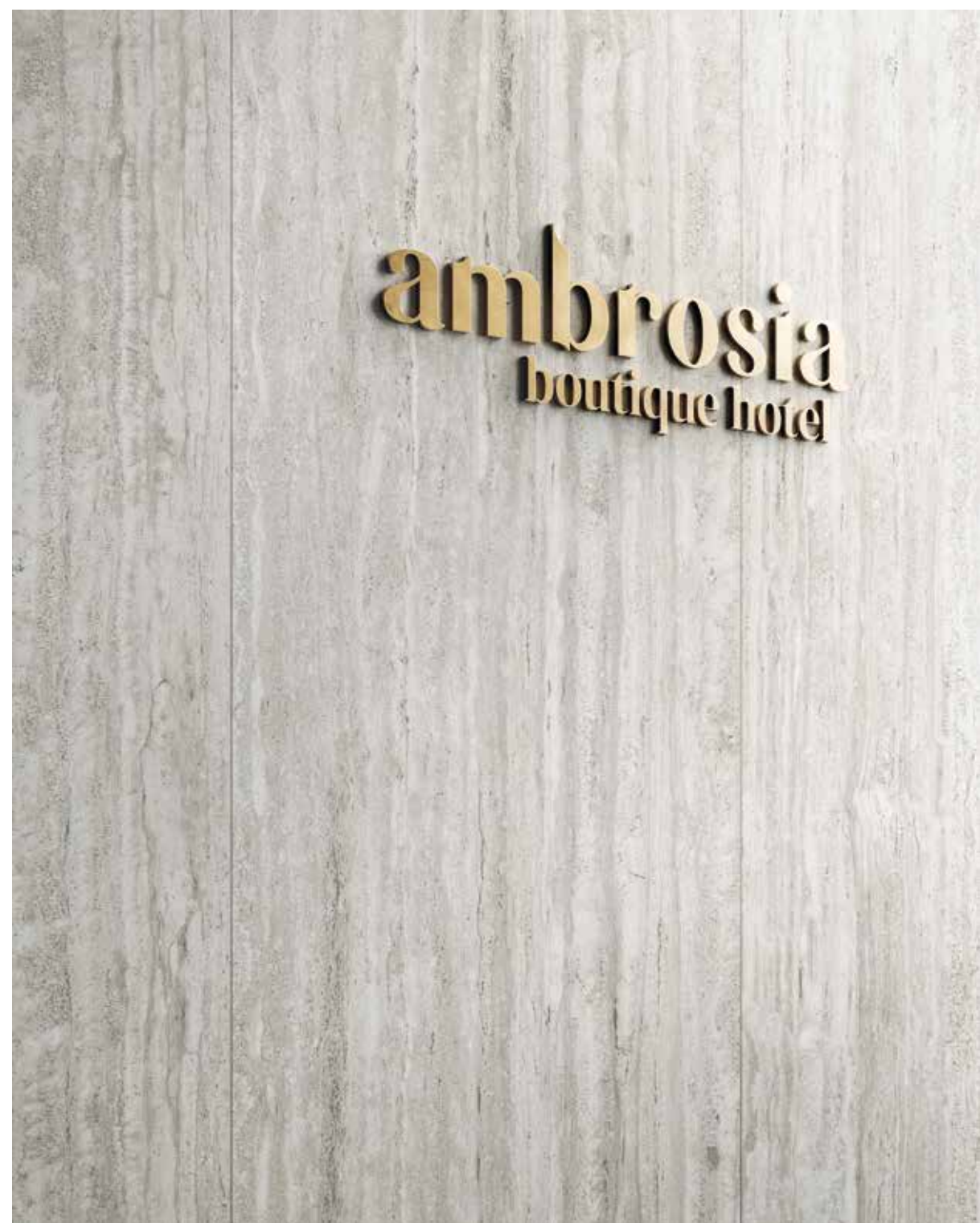

WALL: Travertino Misty **EY 11** 1200x2780 / 48"x110" SP RECT
FLOOR: VICEVERSA Corteccia **VV 08** 800x800 / 31½"x31½" SP RECT



COLORI

Colours | Farben | Couleurs | Colores | Цветов | 种颜色

TRAVERTINO PEARLY EY 10



Formati Nominali Nominal Sizes	Superficie Finish	Spessore mm Thickness mm
300x600 / 12"x24"	NAT / SP RECT	9
600x600 / 24"x24"	NAT / SP RECT	9
600x1200 / 24"x48"	NAT / SP / ST RECT	9
800x800 / 31½"x31½"	SP RECT	9
800x1600 / 31½"x63"	SP RECT	9
1200x1200 / 48"x48"	SP / ST RECT	9
600x1200 / 24"x48"	SP RECT	6
1200x2780 / 48"x110"	SP RECT	6
Line 1200x2780 / 48"x110"	SP RECT	6
1620x3240 / 63¾"x127½"	SP NOT RECT	12

Stucchi consigliati Recommended grouts		
KERAKOLL	20	
MAPEI	111 Grigio Argento	
LATICRETE	44 Bright White	

TRAVERTINO PEARLY CROSS EY 12



Formati Nominali Nominal Sizes	Superficie Finish	Spessore mm Thickness mm
300x600 / 12"x24"	NAT / SP RECT	9
600x600 / 24"x24"	NAT / SP RECT	9
600x1200 / 24"x48"	NAT / SP RECT	9
800x800 / 31½"x31½"	SP RECT	9
1200x1200 / 48"x48"	SP / ST RECT	9
600x600 / 24"x24"	ST RECT	20
600x1200 / 24"x48"	ST RECT	20
800x800 / 31½"x31½"	ST RECT	20

Stucchi consigliati Recommended grouts		
KERAKOLL	20	
MAPEI	111 Grigio Argento	
LATICRETE	44 Bright White	

TRAVERTINO LIGHT EY 07



Formati Nominali Nominal Sizes	Superficie Finish	Spessore mm Thickness mm
300x600 / 12"x24"	NAT / SP RECT	9
600x600 / 24"x24"	NAT / SP RECT	9
600x1200 / 24"x48"	NAT / SP / ST RECT	9
800x800 / 31½"x31½"	SP RECT	9
800x1600 / 31½"x63"	SP RECT	9
1200x1200 / 48"x48"	SP / ST RECT	9
600x1200 / 24"x48"	SP RECT	6
1200x2780 / 48"x110"	SP RECT	6
Line 1200x2780 / 48"x110"	SP RECT	6
1620x3240 / 63¾"x127½"	SP NOT RECT	12
300x1200 / 12"x48"	ST RECT	20
600x1200 / 24"x48"	ST RECT	20

Stucchi consigliati Recommended grouts		
KERAKOLL	43	
MAPEI	111 Grigio Argento	
LATICRETE	85 Almond	

TRAVERTINO LIGHT CROSS EY 13



Formati Nominali Nominal Sizes	Superficie Finish	Spessore mm Thickness mm
300x600 / 12"x24"	NAT / SP RECT	9
600x600 / 24"x24"	NAT / SP RECT	9
600x1200 / 24"x48"	NAT / SP RECT	9
800x800 / 31½"x31½"	SP RECT	9
1200x1200 / 48"x48"	SP / ST RECT	9
600x600 / 24"x24"	ST RECT	20
600x1200 / 24"x48"	ST RECT	20
800x800 / 31½"x31½"	ST RECT	20

Stucchi consigliati Recommended grouts		
KERAKOLL	43	
MAPEI	111 Grigio Argento	
LATICRETE	85 Almond	

TRAVERTINO MISTY EY 11



Formati Nominali Nominal Sizes	Superficie Finish	Spessore mm Thickness mm
300x600 / 12"x24"	NAT / SP RECT	9
600x600 / 24"x24"	NAT / SP RECT	9
600x1200 / 24"x48"	NAT / SP / ST RECT	9
800x800 / 31½"x31½"	SP RECT	9
1200x1200 / 48"x48"	SP / ST RECT	9
600x1200 / 24"x48"	SP RECT	6
1200x2780 / 48"x110"	SP RECT	6
Line 1200x2780 / 48"x110"	SP RECT	6
300x1200 / 12"x48"	ST RECT	20
600x1200 / 24"x48"	ST RECT	20

Stucchi consigliati Recommended grouts		
KERAKOLL	06	
MAPEI	110 Manhattan	
LATICRETE	88 Silver Shadow	

TRAVERTINO MISTY CROSS EY 14



Formati Nominali Nominal Sizes	Superficie Finish	Spessore mm Thickness mm
300x600 / 12"x24"	NAT / SP RECT	9
600x600 / 24"x24"	NAT / SP RECT	9
600x1200 / 24"x48"	NAT / SP RECT	9
800x800 / 31½"x31½"	SP RECT	9
1200x1200 / 48"x48"	SP RECT	9
600x600 / 24"x24"	ST RECT	20
600x1200 / 24"x48"	ST RECT	20
800x800 / 31½"x31½"	ST RECT	20

Stucchi consigliati Recommended grouts		
KERAKOLL	06	
MAPEI	110 Manhattan	
LATICRETE	88 Silver Shadow	

EFFETTO PIETRA

COLORI

Colours | Farben | Couleurs | Colores | Цветов | 种颜色

TRAVERTINO DARK EY 08



Formati Nominali Nominal Sizes	Superficie Finish	Spessore mm Thickness mm
300x600 / 12"x24"	NAT RECT	9
600x600 / 24"x24"	NAT RECT	9
600x1200 / 24"x48"	NAT RECT	9
800x800 / 31½"x31½"	SP RECT	9
1200x1200 / 48"x48"	SP RECT	9
1200x2780 / 48"x110"	SP RECT	6
600x1200 / 24"x48"	ST RECT	20

Stucchi consigliati Recommended grouts	
KERAKOLL	08
MAPEI	112 Grigio Medio
LATICRETE	78 Sterling Silver

TRAVERTINO RUSTIC CROSS EY 15

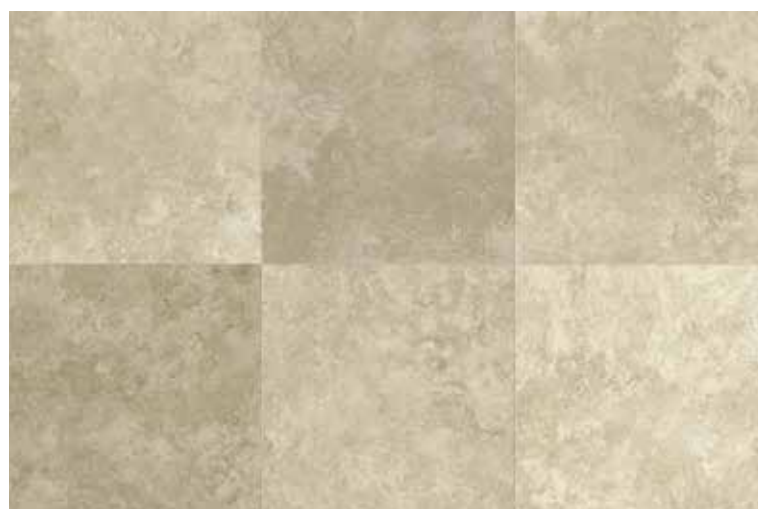

Formati Nominali Nominal Sizes	Superficie Finish	Spessore mm Thickness mm
600x600 / 24"x24"	ST RECT	20

Stucchi consigliati Recommended grouts	
KERAKOLL	43
MAPEI	111 Grigio Argento
LATICRETE	85 Almond

ELYSIAN TRAVERTINI



WALL: Travertino Light **EY 07** 1200x2780 / 48"x110" SP RECT
 FLOOR: CLAY Trust **CL 07** 1200x1200 / 48"x48" SP RECT
 WASHBASIN: BATHMOOD Glad **EY 07** SP + BATHMOOD Horizontal Bliss Mirror **EY 07** SP

RIASSUNTIVO FORMATI ED IMBALLI

Summary of sizes and packaging | Übersicht über Formate und Verpackungen | Récapitulatif formats et emballages
Sinóptico de formatos y embalajes | Краткая информация о форматах и упаковках | 规格和包装概述

		9 mm											
Formati Nominali Nominal Sizes		300x600 12"x24"		600x600 24"x24"		600x1200 24"x48"		800x800 31½"x31½"		800x1600 31½"x63"		1200x1200 48"x48"	
Tutti i formati sono rettificati. All sizes are rectified.													
Superficie Finish		NAT		SP		NAT		SP		NAT		SP	
	TRAVERTINO PEARLY EY 10 V2	■	■	■	■	■	■	■	■	■	■	■	■
	TRAVERTINO LIGHT EY 07 V2	■	■	■	■	■	■	■	■	■	■	■	■
	TRAVERTINO MISTY EY 11 V2	■	■	■	■	■	■	■	■	■	■	■	■
	TRAVERTINO DARK EY 08 V2	■	-	■	-	■	-	-	■	-	■	-	■
	T. PEARLY CROSS EY 12 V2	■	■	■	■	■	■	-	■	-	■	■	■
	T. LIGHT CROSS EY 13 V2	■	■	■	■	■	■	-	■	-	■	■	■
	T. MISTY CROSS EY 14 V2	■	■	■	■	■	■	-	■	-	■	■	-
	T. RUSTIC CROSS EY 15 V4	-	-	-	-	-	-	-	-	-	-	-	-
	Peso lordo per scatola Gross weight per box	25,58	25,58	22,13	22,13	29,56	29,56	29,19	27,36	55,12	61,56	61,56	61,56
	Pezzi per scatola Pieces for box	7	7	3	3	2	2	2	2	2	2	2	2
	mq. scatola sqm. box	1,26	1,23	1,08	1,08	1,44	1,44	1,44	1,28	2,56	2,88	2,88	2,88
	Scatole / Full pallet boxes / Full pallet	40	40	40	40	35	35	35	48	16	20	20	20
	mq. pallet sqm. pallet	50,40	50,40	43,20	43,20	50,40	50,40	50,40	61,44	40,96	57,60	57,60	57,60

TUTTI I FORMATI IN 9 MM NAT SONO REALIZZATI CON LA TECNOLOGIA PERFORMA.
All 9 mm NAT sizes are produced with PERFORMA technology.

		6 mm				12 mm			
Formati Nominali Nominal Sizes		600x1200 24"x48"		1200x2780 48"x110"		Line 1200x2780 48"x110"		1620x3240 63¾"x127½"	
Tutti i formati sono rettificati, eccetto il formato 1620x3240. All sizes except 1620x3240 are rectified.									
Superficie Finish		SP		SP		SP		SP	
	TRAVERTINO PEARLY EY 10 V2	■	■	■	■	■	■	■	■
	TRAVERTINO LIGHT EY 07 V2	■	■	■	■	■	■	■	■
	TRAVERTINO MISTY EY 11 V2	■	■	■	■	■	■	■	■
	TRAVERTINO DARK EY 08 V2	-	-	■	■	-	-	-	-
	Peso lordo per scatola Gross weight per box	-		-		-		-	
	Pezzi per scatola Pieces for box	3		Please refer to page 588		Please refer to page 588		Please refer to page 588	
	mq. scatola sqm. box	2,16		Please refer to page 588		Please refer to page 588		Please refer to page 588	
	Scatole / Full pallet boxes / Full pallet	24		Please refer to page 588		Please refer to page 588		Please refer to page 588	
	mq. pallet sqm. pallet	51,84		Please refer to page 588		Please refer to page 588		Please refer to page 588	

Per garantire elevati standard di sicurezza e le migliori performance tecniche in relazione al loro utilizzo finale (piani cucina, top, arredi), tutte le lastre in formato 1620x3240 in spessore 12mm prevedono l'applicazione di una stuoia in fibra di vetro sul retro della lastra.
All the 1620x3240 slabs in 12mm thickness are provided with a fiberglass mat applied to the back of the slab, to guarantee substantial safety standards and suitable technical performance required for their final use (kitchen countertops, tops, furnishings).

Per tutti i grandi formati è possibile prevedere, su richiesta, e con un lotto minimo l'applicazione di una stuoia in fibra di vetro.
For big sizes, a fiberglass mat can be applied on request, with a minimum production batch.

ACCORGIMENTI SPECIFICI PER L'APPLICAZIONE DELLE GRANDI LASTRE IN 6 MM DI SPESSORE: p. 582 | Precautions for 6mm big slabs applications: page 582 | spezifische Anweisungen zur Nutzung der Grossformate in 6mm: seite 582 | Precauciones específicas para la aplicacion de las grandes placas en 6 mm de espesor: page 582 | Precautions spécifiques pour la pose des grandes plaques en 6mm d'épaisseur: página 582 | специальные предосторожности для укладки больших плит толщиной 6 мм : страница 582

RACCOMANDAZIONI PER UTILIZZO E CURA DELLE LASTRE COUNTERTOPS p. 583 | How to use and take good care of the COUNTERTOPS slabs p. 583 | Tipps für den Einsatz und die Pflege der Platten COUNTERTOPS p. 583 | Recommendations pour l'utilisation et le soin des plaques COUNTERTOPS p.583 | Recomendaciones para el uso y cuidado de las placas COUNTERTOPS p. 583 | Рекомендации по использованию и уходу за плитami COUNTERTOPS p.583 | 规格的COUNTERTOPS系列陶瓷板的使用和护理建议 583

		20 mm							
Formati Nominali Nominal Sizes		600x600 24"x24"		800x800 31½"x31½"		300x1200 12"x48"		600x1200 24"x48"	
Tutti i formati sono rettificati. All sizes are rectified.									
Superficie Finish		ST		ST		ST		ST	
	TRAVERTINO PEARLY EY 10 V2	-	-	-	-	-	-	-	-
	TRAVERTINO LIGHT EY 07 V2	-	-	■	■	■	■	■	■
	TRAVERTINO MISTY EY 11 V2	-	-	■	■	■	■	■	■
	TRAVERTINO DARK EY 08 V2	-	-	-	-	-	-	■	■
	T. PEARLY CROSS EY 12 V2	■	■	■	■	-	-	■	■
	T. LIGHT CROSS EY 13 V2	■	■	■	■	-	-	■	■
	T. MISTY CROSS EY 14 V2	■	■	■	■	-	-	■	■
	T. RUSTIC CROSS EY 15 V4	■	■	-	-	-	-	-	-
	Peso lordo per scatola Gross weight per box	31,14		28,50		32,00		32,00	
	Pezzi per scatola Pieces for box	2		1		2		1	
	mq. scatola sqm. box	0,72		0,64		0,72		0,72	
	Scatole / Full pallet boxes / Full pallet	30		42		36		35	
	mq. pallet sqm. pallet	21,60		26,88		25,92		25,20	

MY NOTES

.....

.....

.....

.....

.....

.....

Maggiori informazioni
More information











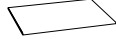



NAT: Naturale | Natural | Natur/unpoliert | Naturelle | Natural | Натуральный | 天然
ST: Strutturata | Structured | Strukturiert | Structuré | Estructurado | Труктурированный | 结构
SP: Spazzolata











EFFETTO PIETRA

PEZZI SPECIALI

Special pieces | Sonderstücke | Pièces spéciales | Piezas especiales | специальные изделия | 特殊件

	 Gradino A*	 Gradino A*	 Gradino A*	 Gradino B	 Gradino B	 Gradino B
Pezzi speciali Special pieces	300x600 12"x24"	330x800 13 1/8"x31 1/2"	330x1200 13 1/8"x48"	330x600 13 1/8"x24"	330x800 13 1/8"x31 1/2"	330x1200 13 1/8"x48"
Superficie Finish	NAT	SP	NAT	NAT	SP	NAT
 TRAVERTINO PEARLY EY 10	■	■	■	■	■	■
 TRAVERTINO LIGHT EY 07	■	■	■	■	■	■
 TRAVERTINO MISTY EY 11	■	■	■	■	■	■
 TRAVERTINO DARK EY 08	■	■	■	■	■	■
 T. PEARLY CROSS EY 12	■	■	■	■	■	■
 T. LIGHT CROSS EY 13	■	■	■	■	■	■
 T. MISTY CROSS EY 14	■	■	■	■	■	■
Pezzi per scatola Pieces for box	7	7	4	4	4	2

* **Finitura a becco di civetta** | One-round edge shaping | Ausführung mit Eckabrundung | Façonnage à bord rond | Acabado canto romo | Плитка с завалом | 鹰嘴边缘处理

	 Gradino B ang.	 Battiscopa*	 Gradino G*	 Gradino G*
Pezzi speciali Special pieces	330x330 13 1/8"x13 1/8"	72x600 2 7/8"x24"	72x800 2 7/8"x31 1/2"	300x600 12"x24"
Superficie Finish	NAT	SP	NAT	SP
 TRAVERTINO PEARLY EY 10	■	■	■	■
 TRAVERTINO LIGHT EY 07	■	■	■	■
 TRAVERTINO MISTY EY 11	■	■	■	■
 TRAVERTINO DARK EY 08	■	■	■	■
 T. PEARLY CROSS EY 12	■	■	■	■
 T. LIGHT CROSS EY 13	■	■	■	■
 T. MISTY CROSS EY 14	■	■	■	■
Pezzi per scatola Pieces for box	4	4	10	7

NAT: Naturale | Natural | Natur/unpoliert | Naturelle | Natural | Натуральный | 天然
ST: Strutturata | Structured | Strukturiert | Structuré | Estructurado | Труктурированный | 结构
SP: Spazzolata

ELYSIAN TRAVERTINI

DECORI

Decors | Dekore | Decors | Decoros | Декоры | 装饰砖

 **Layer NAT**
300x600 / 12"x24"



TRAVERTINO LIGHT **EY 07**



TRAVERTINO DARK **EY 08**



TRAVERTINO PEARLY **EY 10**



TRAVERTINO MISTY **EY 11**



TRAVERTINO PEARLY CROSS **EY 12**



TRAVERTINO LIGHT CROSS **EY 13**



TRAVERTINO MISTY CROSS **EY 14**

 **Mosaico 36T NAT**
300x300 / 12"x12"
Tessere 48x48 / 2"x2"



TRAVERTINO LIGHT **EY 07**



TRAVERTINO DARK **EY 08**



TRAVERTINO PEARLY **EY 10**



TRAVERTINO MISTY **EY 11**



TRAVERTINO PEARLY CROSS **EY 12**



TRAVERTINO LIGHT CROSS **EY 13**



TRAVERTINO MISTY CROSS **EY 14**

 **Pezzi per scatola**
Pieces for box

Mosaico 36T 6

Layer 4

MOSAICO 36T, LAYER:
Decoro su rete | Mesh-backed decoration | Dekor auf netz | Décor sur filet | Decoración en red | Декор в сету | 网板背帖装饰件

Una nuova proposta decorativa che esalta le superfici, per un effetto dalla profondità sorprendente.

A new decorative effect that brings out the astonishing depth of our surfaces.

Line SP RECT
1200x2780 / 48"x110"



TRAVERTINO PEARLY **EY 10**

Line SP RECT
1200x2780 / 48"x110"



TRAVERTINO LIGHT **EY 07**

Line SP RECT
1200x2780 / 48"x110"



TRAVERTINO MISTY **EY 11**

CARATTERISTICHE TECNICHE

Technical specifications | Technische Eigenschaften | Caractéristiques techniques | Características técnicas | Технические характеристики | 技术特征

STANDARD EN 14411 - G

CARATTERISTICHE TECNICHE TECHNICAL DATA TECHNISCHE DATEN CARACTERISTIQUES TECHNIQUES CARACTERÍSTICAS TÉCNICAS ТЕХНИЧЕСКИЕ ХАРАКТЕРИСТИКИ 技术特征	NORMA STANDARD NORM NORME NORMA СТАНДАРТИ 标准	VALORI PRESCRITTI DALLE NORME EN 14411 - G INTERNATIONAL STANDARDS EN 14411 - G INTERNATIONALE NORMWERTE EN 14411 - G VALEURS PREVUES PAR LES NORMES EN 14411 - G VALORES PREVISTOS POR LAS NORMAS EN 14411 - G ПРЕДУСМОТРЕННЫЕ СТАНДАРТОМ EN 14411-G EN 14411 - G标准规定值	*VALORE MEDIO MIRAGE MIRAGE AVERAGE VALUE MIRAGE MITTELWERT VALEURS MOYEN MIRAGE VALOR MEDIO MIRAGE СРЕДНЕЕ ЗНАЧЕНИЕ MIRAGE MIRAGE平均值
CARATTERISTICHE DIMENSIONALI - SIZE CHARACTERISTICS - MASSEIGENSCHAFTEN DETERMINATION DES CARACTERISTIQUES DIMENSIONELLES - CARACTERÍSTICAS DIMENSIONALES - РАЗМЕРНЫЕ ХАРАКТЕРИСТИКИ - 尺寸特征			
LATI SIDES - SEITEN COTES - CANTOS РАЗМЕРЫ СТОРОН - 侧边	EN ISO 10545-2	± 0,3% MAX (± 1,0 mm MAX)	CONFORME COMPLYING
SPESSORE THICKNESS - DICKE ÉPAISSEUR - ESPESOR ТОЛЩИНА - 厚度	EN ISO 10545-2	± 5,0% MAX (± 0,5 mm MAX)	CONFORME COMPLYING
RETTILINEITÀ DEGLI SPIGOLI STRAIGHTNESS OF SIDES - GERADLINIGKEIT DER KANTEN RECTITUDE DES ARETES - RECTITUD DE LOS CANTOS КОСОУГОЛЬНОСТЬ - 边角平直度	EN ISO 10545-2	± 0,3% MAX (± 0,8 mm MAX)	CONFORME COMPLYING
ORTOGONALITÀ RECTANGULARITY - RECHTWINKLIGKEIT PERPENDICULARITÉ - ORTOGONALIDAD КРИВИЗНА СТОРОН - 直角度	EN ISO 10545-2	± 0,3% MAX (± 1,5 mm MAX)	CONFORME COMPLYING
PLANARITÀ SURFACE FLATNESS - EBENFLÄCHIGKEIT PLANEITE DE SURFACE - PLANEIDAD КРИВИЗНА ЛИЦЕВОЙ ПОВЕРХНОСТИ - 平整度	EN ISO 10545-2	± 0,4% MAX (± 1,8 mm MAX)	CONFORME COMPLYING
ASSORBIMENTO D'ACQUA WATER ABSORPTION - WASSERAUFNAHME ABSORPTION D'EAU - ABSORCIÓN DE AGUA ВОДОПОГЛОЩЕНИЕ - 吸水率	EN ISO 10545-3	≤ 0,5%	≤ 0,1%
RESISTENZA ALLA FLESSIONE FLEXION RESISTANCE - BIEGEFESTIGKEIT RESISTANCE A LA FLEXION - RESISTENCIA A LA FLEXIÓN ПРЕДЕЛ ПРОЧНОСТИ ПРИ ИЗГИБЕ - 抗弯强度	EN ISO 10545-4	S ≥ 700 N (< 7,5 mm) S ≥ 1.300 N (> 7,5 mm) R ≥ 35 N/mm ² .	±6 mm: S≥1100N R≥45N/mm ² ±9 mm: S≥2.400N R≥48N/mm ² ±20 mm: S≥12.500N R≥48N/mm ²
RESISTENZA ALL'URTO IMPACT RESISTANCE - STOSSFESTIGKEIT RESISTANCE AUX CHOCS - RESISTENCIA A LOS GOLPES УДАРСТОЙКОСТЬ - 抗冲击强度	EN ISO 10545-5	VALORE DICHIARATO DECLARED VALUE	> 0,80
RESISTENZA ALL'ABRAZIONE ABRASION RESISTANCE - ABRIEBFESTIGKEIT RESISTANCE A L'ABRASION - RESISTENCIA A LA ABRASIÓN СТОЙКОСТЬ К ИСТИРАНИЮ - 耐磨强度	EN ISO 10545-6	≤ 175 mm ³	< 150 mm ³
COEFFICIENTE DI DILATAZIONE TERMICA LINEARE COEFFICIENT OF LINEAR THERMAL-EXPANSION - LINEARER WÄRMEAUDEHNUNGSKOEFFIZIENT COEFFICIENT DE DILATATION THERMIQUE LINEAIRE - COEFFICIENTE DE DILATACIÓN TÉRMICA LINEAL КОЭФФИЦИЕНТ ЛИНЕЙНОГО ТЕРМИЧЕСКОГО РАСТЯЖЕНИЯ - 线性热膨胀系数	EN ISO 10545-8	-	α=6,6x10 ⁻⁶ °C ⁻¹
RESISTENZA AGLI SBALZI TERMICI RESISTANCE TO THERMAL SHOCKS - BESTÄNDIGKEIT GEGEN TEMPERATURSCHWANKUNGEN RESISTANCE AUX CHOCS THERMIQUES - RESISTENCIA A LOS CHOQUES TÉRMICOS СТОЙКОСТЬ К ПЕРЕПАДАМ ТЕМПЕРАТУРЫ - 耐热突变性	EN ISO 10545-9	TEST SUPERATO SECONDO EN ISO 10545-1 PASS ACCORDING EN ISO 10545-1	NESSUN DANNO NO DAMAGE
RESISTENZA AL GELO FROST RESISTANCE - FROSTBESTÄNDIGKEIT RESISTANCE AU GEL - RESISTENCIA AL HIELO МОРОЗОСТОЙКОСТЬ - 耐冻性	EN ISO 10545-12	TEST SUPERATO SECONDO EN ISO 10545-1 PASS ACCORDING EN ISO 10545-1	NESSUN DANNO NO DAMAGE
RESISTENZA ALL'ATTACCO CHIMICO RESISTANCE TO CHEMICALS - CHEMIKALIENBESTÄNDIGKEIT RESISTANCE A L'ATTAQUE CHIMIQUE - RESISTENCIA QUÍMICA ХИМИЧЕСКАЯ СТОЙКОСТЬ - 耐化学药品作用	EN ISO 10545-13	B MIN.	A LA HA
RESISTENZA ALLE MACCHIE RESISTANCE TO STAINS - FLECKENBESTÄNDIGKEIT RESISTANCE AUX TACHES - RESISTENCIA A LAS MANCHAS УСТОЙЧИВОСТЬ К ПЯТНООБРАЗОВАНИЮ - 防污性	EN ISO 10545-14	VALORE DICHIARATO DECLARED VALUE	5
CESSIONE DI PIOMBO E CADMIO LEAD AND CADMIUM DISCHARGE - ABGABE VON BLEI UND CADMIUM PERTE DE PLOMB ET CADMIUM - CESIÓN DE PLOMO Y CADMIO ВЫДЕЛЕНИЕ СВИНЦА И КАДМИЯ - 铅和镉的排放	EN ISO 10545-15	VALORE DICHIARATO DECLARED VALUE	< AL LIMITE DI RILEVAMENTO < THAN INSTRUMENT LIMIT
			NAT SP ST 20 mm
	DM 236/89 BCRA	> 0,40	> 0,40 > 0,40 > 0,40
	ANSI A326.3	Wet and Dry	≥ 0,42 ≥ 0,42 ≥ 0,55
	AS 4586	-	P3 P2 -
	DIN 51130	-	R10 R9 R11
	DIN 51097	-	A+B - A+B+C
	UNE 41901	≥ CL1	CL2 CL1 CL3
	BS 7976 sl.96-4S	Wet and Dry	≥ 0,36 - ≥ 0,36
	BS 7976 sl.55-TRL	Wet and Dry	≥ 0,36 - ≥ 0,36
SCIVOLOSITÀ SKID RESISTANCE - RUTSCHWERT GLISSANCE - ADHERENCIA СКОЛЬЗКОСТЬ - 防滑性			

Per i certificati specifici, contattare Mirage SpA - For specific certificates, please contact Mirage SpA - Für die speziellen Zertifikate wenden Sie sich bitte an Mirage SpA - Pour les certificats spécifiques, veuillez contacter Mirage SpA
Para los certificados específicos, contactar Mirage SpA - Для сертификатов обращайтесь в компанию Mirage SpA - 关于具体的证书, 请联系Mirage SpA公司



WALL: MIROIR Gold 1200x2780 / 48"x110"
 FLOOR: JEWELS Moonless JW 17 1600x1600 / 63"x63" LUC RECT

EMPORIO 225

EMPORIO 225 is the **COVERING MATERIAL** collection that combines creativity and style research into a perfect balance.

The materials take on a key role in shaping spaces, with products featuring a **mirroring or natural inspiration with geometric, abstract and figurative patterns.**



WALL: CHARME Tissue Rose 75x280 / 3"x11"
 GLOCAL Classic GC 05 1200x2400 / 48"x96" SP RECT
 FLOOR: GLOCAL Classic GC 05 1200x1200 / 48"x48" SP RECT

COLORI

Colours | Farben | Couleurs | Colores | Цветов | 种颜色

1200x2780 / 48"x110"



Gold



Platinum

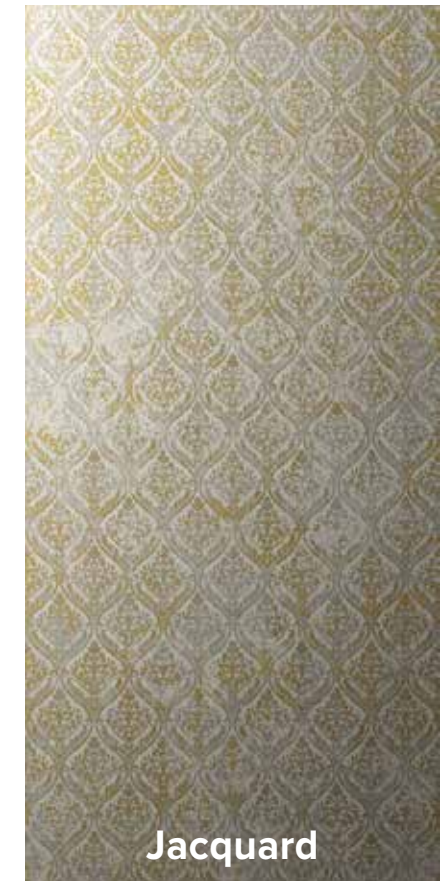

Jacquard



Expo



Stripes



Sakura



Jungle











Peony

WALL: MIROIR Expo 1200x2780 / 48"x110"
FLOOR: GLOCAL Absolute **gc 06** 1200x1200 / 48"x48" SP RECT

DESIGN

RIASSUNTIVO FORMATI ED IMBALLI

Summary of sizes and packaging | Übersicht über Formate und Verpackungen | Récapitulatif formats et emballages
Sinóptico de formatos y embalajes | Краткая информация о форматах и упаковках | 规格和包装概述

		± 6 mm	
Formati Nominali Nominal Sizes		1200x2780 48"x110"	
	GOLD	1 graphic available	▪
	PLATINUM	1 graphic available	▪
	JACQUARD	1 graphic available	▪
	EXPO	1 graphic available	▪
	STRIPES	1 graphic available	▪
	SAKURA	1 graphic available	▪
	JUNGLE	1 graphic available	▪
	PEONY	1 graphic available	▪

Accorgimenti generali per lastre in gres porcellanato MIRAGE MIROIR alla pagina 584.
General precautions for MIRAGE MIROIR slabs in porcelain stoneware on page 584.



WALL: MIROIR Sakura 1200x2780 / 48"x110"
FLOOR: ELYSIAN Mediterranea EY 01 1200x1200 / 48"x48" SP RECT

COLORI
Colours | Farben | Couleurs | Colores | Цветов | 种颜色

TISSUE 75x280 / 3"x11"

PASTEL TISSUE 75x280 / 3"x11"

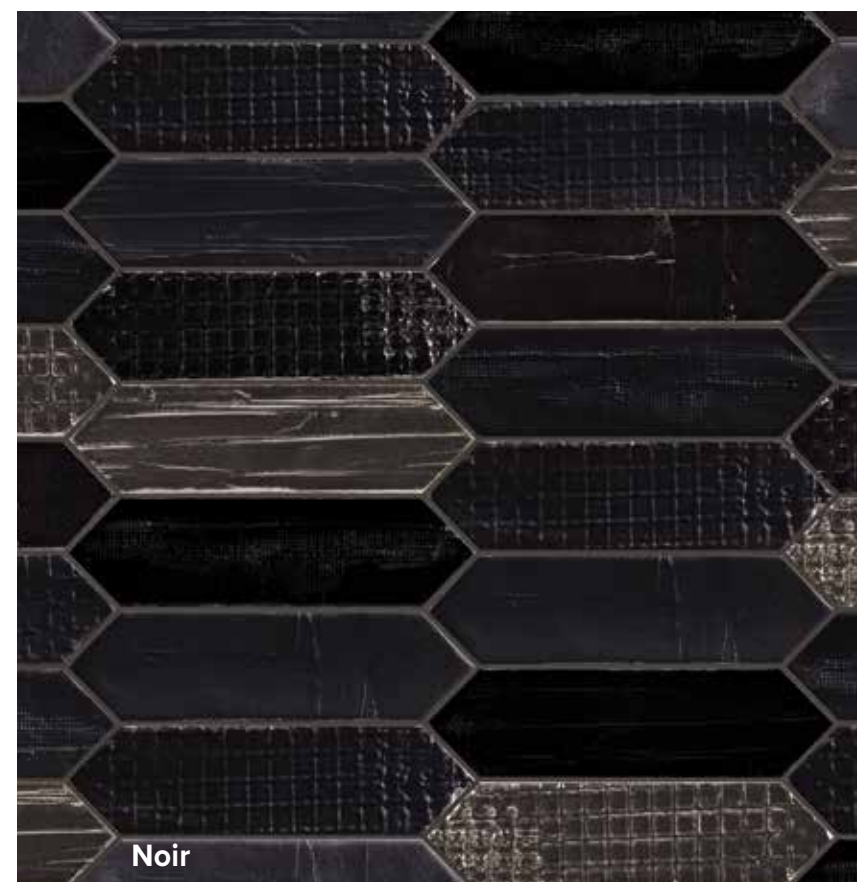

WALL: CHARME Tissue Azul 75x280 / 3"x11" | JEWELS Statuario Lunensis JW 12 1200x2400 / 48"x110" LUC RECT
FLOOR: GLOCAL Classic GC 05 600x600 / 24"x24" NAT RECT

COLORI
Colours | Farben | Couleurs | Colores | Цветов | 种颜色

RUCHE 125x109 / 5"x4½"



WALL: CHARME Ruche Noir 125x109 / 5"x4½"
FLOOR: GLOCAL Perfect GC 02 600x1200 / 24"x48" NAT RECT



Blanc



Noir

COLORI
Colours | Farben | Couleurs | Colores | Цветов | 种颜色

MAIOLICHE di SANT'ANTONIO 150x150 / 6"x6"

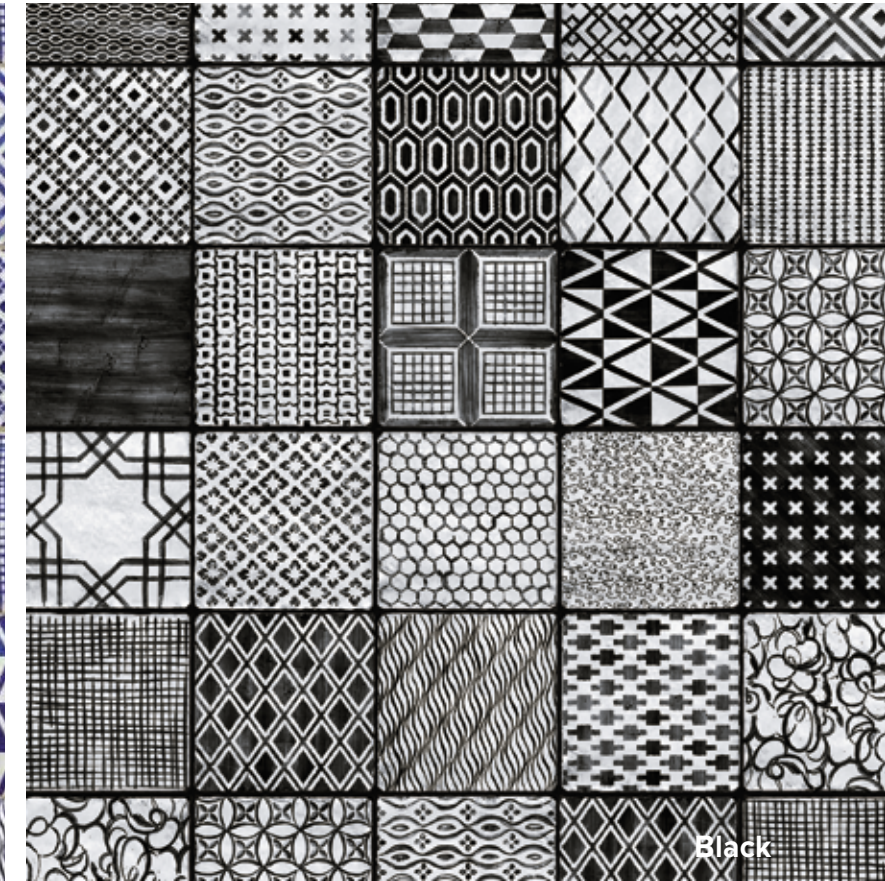

FLOOR: CHARME Maioliche di Sant'Antonio Black

RIASSUNTIVO FORMATI ED IMBALLI

Summary of sizes and packaging | Übersicht über Formate und Verpackungen | Récapitulatif formats et emballages
Sinóptico de formatos y embalajes | Краткая информация о форматах и упаковках | 规格和包装概述

TISSUE - RUCHE

Formati Nominali Nominal Sizes		75x280 3"x11"	125x109 5"x4"
TISSUE	7 available colors	■	-
RUCHE	2 available colors	-	■
Pezzi per scatola Pieces for box		22	44

MAIOLICHE DI SANT'ANTONIO

Formati Nominali Nominal Sizes		150x150 6"x6"
BLACK		■
BLUE		■
MIX		■
TAUPE		■
Pezzi per scatola Pieces for box		8

BACCHETTE

Formati Nominali Nominal Sizes		5x600 3/16"x24"
BACCHETTA GLITTER ORO		■
Pezzi per scatola Pieces for box		10



Tutti i decori Charme sono realizzati in tecnica semiartigianale.
I diversi smalti, utilizzati per la realizzazione degli stessi, hanno infatti caratteristiche di superficie particolari, pertanto ogni effetto di irregolarità è da considerarsi come caratteristica di pregio del decoro. Per la posa raccomandiamo una miscelazione random dei pezzi, per ottenere il risultato estetico migliore.

All Charme Decors are made using a semi-artisan technique.
The various enamels used have distinctive surface characteristics, so any uneven effects are to be considered a sign of a quantity decorative element. When laying we recommend mixing the pieces randomly for best results.

WALL: CHARME Tissue Noir 75x280 / 3"x11"
FLOOR: GLOCAL Absolute GC 06 600x600 / 24"x24" SP RECT

COLORI

Colours | Farben | Couleurs | Colores | Цветов | 种颜色

800x1600 / 31½"x63"



WALL: Separé White Crystal **CP 05** 800x1600 / 31½"x63" LUC
FLOOR: COSMOPOLITAN White Crystal **CP 05** 800x800 / 31½"x31½" LUC RECT



Calacatta Gold
CP 02



White Crystal
CP 05



Mystic Grey
CP 06



Clear
GC 01



Perfect
GC 02















Ideal
GC 03

DESIGN

RIASSUNTIVO FORMATI ED IMBALLI

Summary of sizes and packaging | Übersicht über Formate und Verpackungen | Récapitulatif formats et emballages
Sinóptico de formatos y embalajes | Краткая информация о форматах и упаковках | 规格和包装概述

		± 6 mm
	Formati Nominali Nominal Sizes	800x1600 31½"x63"
	Superficie Finish	SP
	CLEAR GC 01	■
	PERFECT GC 02	■
	IDEAL GC 03	■
	Pezzi per scatola Pieces for box	1

		± 9 mm
	Formati Nominali Nominal Sizes	800x1600 31½"x63"
	Superficie Finish	LUC
	CALACATTA GOLD CP 02	■
	WHITE CRYSTAL CP 05	■
	MYSTIC GREY CP 06	■
	Pezzi per scatola Pieces for box	1

EMPORIO 225

SEPARÉ



PRODOTTO ADATTO ESCLUSIVAMENTE PER L'APPLICAZIONE A RIVESTIMENTO. | Ausschließlich für die Anwendung als Wandverkleidung geeignetes Produkt. | Produit adapté exclusivement à une application en revêtement. | Producto solo apto para aplicación como revestimiento. | Продукт, подходящий для применения в качестве настенной облицовки | 产品只适用于墙体应用。

WALL: Separé Ideal **GC 01** 800x1600 / 31½"x63" SP
FLOOR: GLOCAL Ideal **GC 01** 800x800 / 31½"x31½" SP RECT



WALL: NYUMA Talcum **NY 05** 1200x2780 / 48"x110" SP RECT
 FLOOR: KAO Cocoa **KA 05** 200x1200 / 8"x48" SP RECT
 COUNTER and FURNITURE: NYUMA Talcum **NY 05** SP + SISTIEX 150x150 / 6"x6"

COLORI

Colours | Farben | Couleurs | Colores | Цветов | 种颜色

150x150 / 6"x6"



Shell

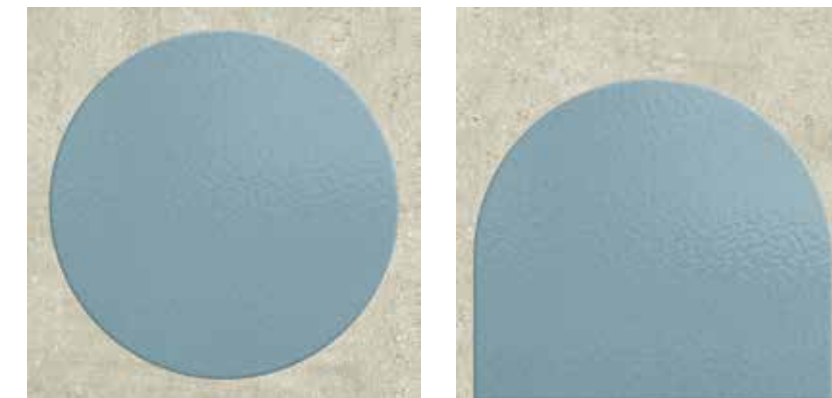

Coral

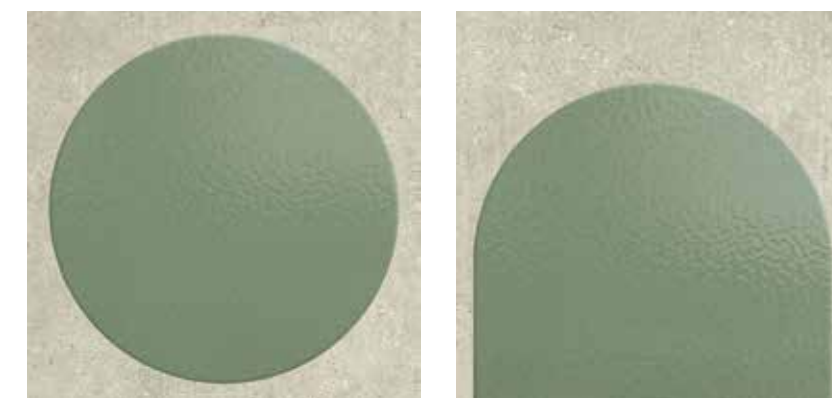

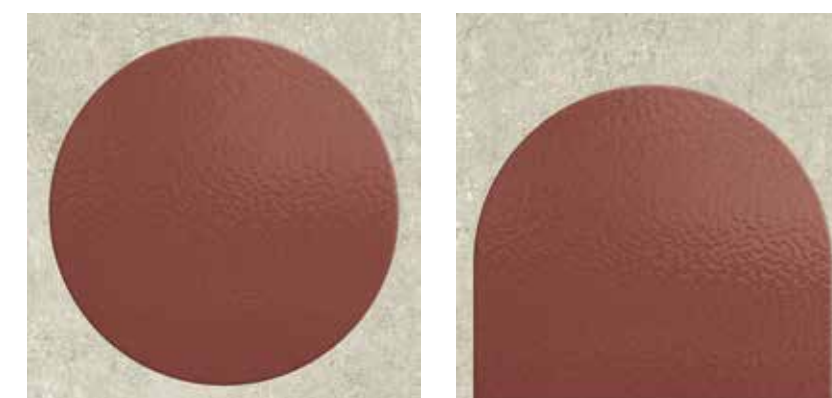

Sage



Berry

PRODOTTO ADATTO ESCLUSIVAMENTE PER L'APPLICAZIONE A RIVESTIMENTO. | Ausschließlich für die Anwendung als Wandverkleidung geeignetes Produkt. | Produit adapté exclusivement à une application en revêtement. | Producto solo apto para aplicación como revestimiento. | Продукт, подходящий для применения в качестве настенной облицовки | 产品只适用于墙体应用。

 Formati Nominali	150x150
Nominal Sizes	6"x6"
SHELL	▪
CORAL	▪
SAGE	▪
BERRY	▪
 Pezzi per scatola	8
Pieces for box	

COLORI

Colours | Farben | Couleurs | Colores | Цветов | 种颜色

600x1200 / 24"x48"



WALL: CLAY Karma **CL 08** 600x1200 / 24"x48" SP RECT + RAKU Momoyama 600x1200 / 24"x48"
 FLOOR: CLAY Verve **CL 05** 800x800 / 31½"x31½" SP RECT
 FURNITURE: NORR Farge **RR 05** NAT



Momoyama



Kyoto



Rikyu

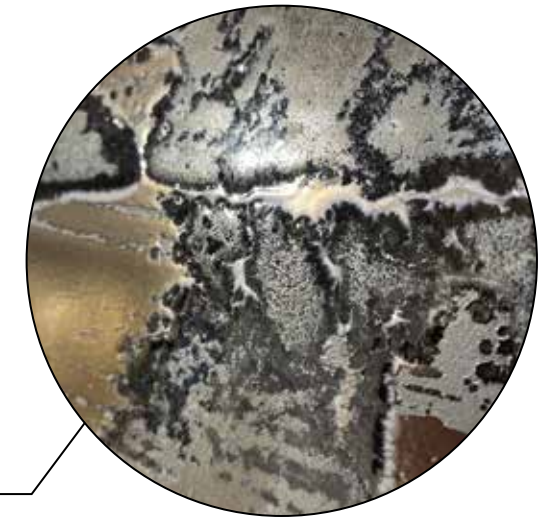

PRODOTTO ADATTO ESCLUSIVAMENTE PER L'APPLICAZIONE A RIVESTIMENTO. | Ausschließlich für die Anwendung als Wandverkleidung geeignetes Produkt. | Produit adapté exclusivement à une application en revêtement. | Producto solo apto para aplicación como revestimiento. | Продукт, подходящий для применения в качестве настенной облицовки | 产品只适用于墙体应用。

Formati Nominali Nominal Sizes	600x1200 24"x48"
KYOTO	▪
RIKYU	▪
MOMOYAMA	▪
Pezzi per scatola Pieces for box	2

COLORI
Colours | Farben | Couleurs | Colores | Цветов | 种颜色

1200x2780 / 48"x110"

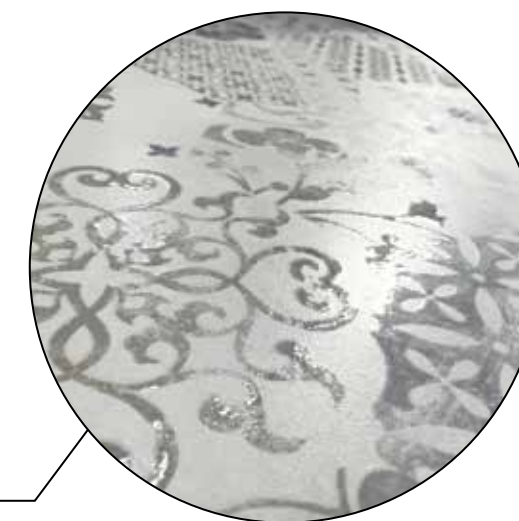

FLOOR: OUDH Cedro **OU 07** 250x1500 / 10"x60" SP RECT
COUNTER: Positano 1200x2780 / 48"x110" SP RECT

PRODOTTO ADATTO PER APPLICAZIONE A RIVESTIMENTO E PAVIMENTO (TRAFFICO LEGGERO). | Product suitable for wall and floor applications (light traffic).

EFFETTO CEMENTO/RESINA



FLOOR: Type **GC 04** 600x600 / 24"x24" SP RECT
WALL: Nebula **GC 11** 1200x2780 / 48"x110" SP RECT | Cube **Green** Nebula **GC 11** 150x150 / 6"x6"

GLOCAL

x Giulio Cappellini

GLOCAL recalls the most neutral and eclectic soul of **SMOOTH CONCRETE**.

Giulio Cappellini guided a meticulous renewal of the collection, displaying a more contemporary version, adding eight new colors accompanied by contemporary decorative solutions.



WALL: Youth **GC 15** 600x1200 / 24"x48" SP RECT

COLORI
Colours | Farben | Couleurs | Colores | Цветов | 种颜色



FLOOR: Journey **GC 13** 1200x1200 / 48"x48" SP RECT
WALL: Skin Journey **GC 13** 1200x2780 / 48"x110"





FLOOR: Clear **GC 01** 600x1200 / 24"x48" SP RECT + Youth **GC 15** 600x1200 / 24"x48" SP RECT
WALL: Youth **GC 15** 600x1200 / 24"x48" SP RECT + Lumina **GC 18** 1200x2780 / 48"x110" SP RECT
FOREGROUND WALL: Turquoise **GC 13** Journey 150x150 / 6"x6"

COLORI

Colours | Farben | Couleurs | Colores | Цветов | 种颜色

CLEAR **GC 01**



Formati Nominali Nominal Sizes	Superficie Finish	Spessore mm Thickness mm
300x300 / 12"x12"	NAT RECT	9
150x600 / 6"x24"	SP RECT	9
300x600 / 12"x24"	NAT / SP / ST RECT	9
600x600 / 24"x24"	NAT / SP / ST RECT	9
600x600 / 24"x24"	SP RECT	20
600x1200 / 24"x48"	NAT / SP / ST RECT	9
800x800 / 31½"x31½"	NAT / SP RECT	9
800x1600 / 31½"x31½"	SP RECT	9
1200x1200 / 48"x48"	SP RECT	9
1200x2400 / 48"x96"	SP RECT	9
600x1200 / 24"x48"	SP RECT	6
1200x1200 / 48"x48"	NAT RECT	6
1200x2780 / 48"x110"	SP RECT	6
1600x1600 / 63"x63"	SP RECT	6
1600x3200 / 63"x126"	SP RECT	6
1620x3240 / 63¾"x127½"	SP NOT RECT	12

Stucchi consigliati Recommended grouts	
KERAKOLL	05
MAPEI	111 Grigio Argento
LATICRETE	88 Silver Shadow

IDEAL **GC 03**



Formati Nominali Nominal Sizes	Superficie Finish	Spessore mm Thickness mm
300x300 / 12"x12"	NAT RECT	9
150x600 / 6"x24"	SP RECT	9
300x600 / 12"x24"	NAT / SP / ST RECT	9
600x600 / 24"x24"	NAT / SP / ST RECT	9
600x600 / 24"x24"	SP RECT	20
600x1200 / 24"x48"	NAT / SP / ST RECT	9
800x800 / 31½"x31½"	NAT / SP RECT	9
800x1600 / 31½"x31½"	SP RECT	9
1200x1200 / 48"x48"	SP RECT	9
1200x2400 / 48"x96"	SP RECT	9
600x1200 / 24"x48"	SP RECT	6
1200x1200 / 48"x48"	NAT RECT	6
1200x2780 / 48"x110"	SP RECT	6
1600x1600 / 63"x63"	SP RECT	6
1600x3200 / 63"x126"	SP RECT	6
1620x3240 / 63¾"x127½"	SP NOT RECT	12
600x600 / 24"x24"	ST RECT	20
600x1200 / 24"x48"	ST RECT	20
800x800 / 31½"x31½"	ST RECT	20
1200x1200 / 48"x48"	ST RECT	20
600x600 / 24"x24"	ST RECT	30

Stucchi consigliati Recommended grouts	
KERAKOLL	08
MAPEI	112 Grigio Medio
LATICRETE	78 Sterling Silver

PERFECT **GC 02**

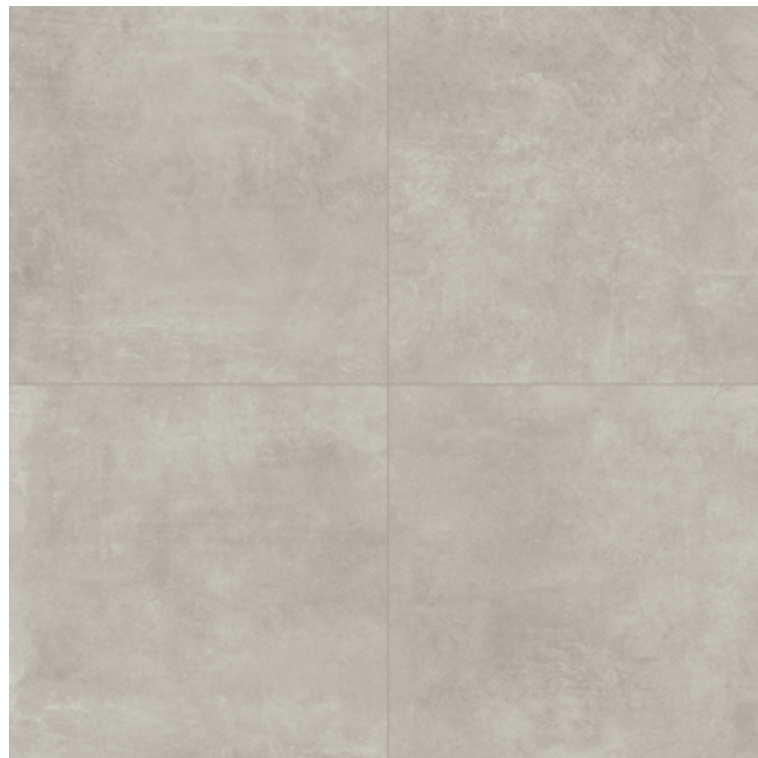

Formati Nominali Nominal Sizes	Superficie Finish	Spessore mm Thickness mm
300x300 / 12"x12"	NAT RECT	9
150x600 / 6"x24"	SP RECT	9
300x600 / 12"x24"	NAT / SP / ST RECT	9
600x600 / 24"x24"	NAT / SP / ST RECT	9
600x600 / 24"x24"	SP RECT	20
600x1200 / 24"x48"	NAT / SP / ST RECT	9
800x800 / 31½"x31½"	NAT / SP RECT	9
800x1600 / 31½"x31½"	SP RECT	9
1200x1200 / 48"x48"	SP RECT	9
1200x2400 / 48"x96"	SP RECT	9
600x1200 / 24"x48"	SP RECT	6
1200x1200 / 48"x48"	NAT RECT	6
1200x2780 / 48"x110"	SP RECT	6
1600x1600 / 63"x63"	SP RECT	6
1600x3200 / 63"x126"	SP RECT	6
600x600 / 24"x24"	ST RECT	20
600x1200 / 24"x48"	ST RECT	20
800x800 / 31½"x31½"	ST RECT	20
1200x1200 / 48"x48"	ST RECT	20

Stucchi consigliati Recommended grouts	
KERAKOLL	06
MAPEI	110 Manhattan
LATICRETE	89 Smoke Grey

TYPE **GC 04**

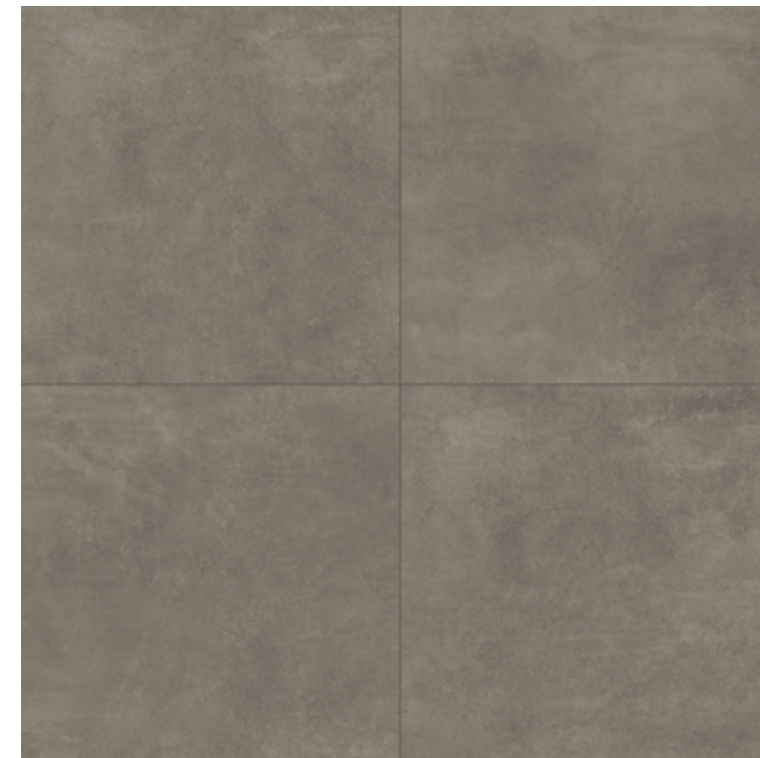

Formati Nominali Nominal Sizes	Superficie Finish	Spessore mm Thickness mm
150x600 / 6"x24"	SP RECT	9
300x600 / 12"x24"	NAT / SP / ST RECT	9
600x600 / 24"x24"	NAT / SP / ST RECT	9
600x1200 / 24"x48"	SP / NAT RECT	9
800x800 / 31½"x31½"	NAT / SP RECT	9
1200x1200 / 48"x48"	SP RECT	9
1200x2400 / 48"x96"	SP RECT	9
600x600 / 24"x24"	ST RECT	20
600x1200 / 24"x48"	ST RECT	20
800x800 / 31½"x31½"	ST RECT	20
1200x1200 / 48"x48"	ST RECT	20
600x600 / 24"x24"	ST RECT	30

Stucchi consigliati Recommended grouts	
KERAKOLL	36
MAPEI	113 Grigio Cemento
LATICRETE	34 Sand Stone

COLORI

Colours | Farben | Couleurs | Colores | Цветов | 种颜色

CLASSIC GC 05

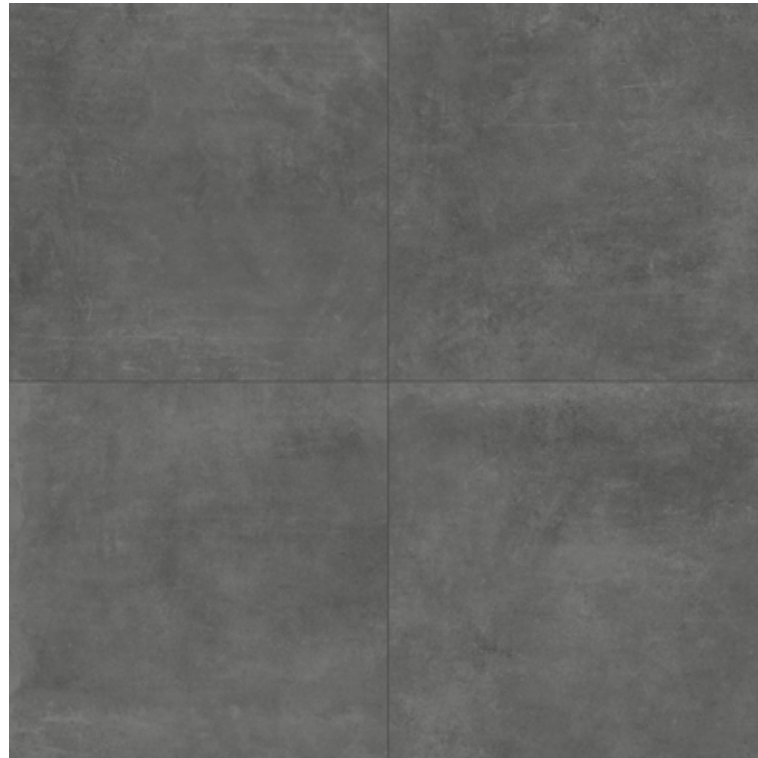

Formati Nominali Nominal Sizes	Superficie Finish	Spessore mm Thickness mm
150x600 / 6"x24"	SP RECT	9
300x600 / 12"x24"	NAT / SP / ST RECT	9
600x600 / 24"x24"	NAT / SP / ST RECT	9
600x600 / 24"x24"	SP RECT	20
600x1200 / 24"x48"	SP / NAT RECT	9
800x800 / 31½"x31½"	NAT / SP RECT	9
1200x1200 / 48"x48"	SP RECT	9
1200x2400 / 48"x96"	SP RECT	9
600x600 / 24"x24"	ST RECT	20
600x1200 / 24"x48"	ST RECT	20
800x800 / 31½"x31½"	ST RECT	20
1200x1200 / 48"x48"	ST RECT	20
600x600 / 24"x24"	ST RECT	30

Stucchi consigliati
Recommended grouts

KERAKOLL	10
MAPEI	114 Antracite
LATICRETE	45 Raven

SUGAR GC 07



Formati Nominali Nominal Sizes	Superficie Finish	Spessore mm Thickness mm
150x600 / 6"x24"	SP RECT	9
300x600 / 12"x24"	NAT / SP / ST RECT	9
600x600 / 24"x24"	NAT / SP / ST RECT	9
600x600 / 24"x24"	SP RECT	20
600x1200 / 24"x48"	NAT / SP / ST RECT	9
800x800 / 31½"x31½"	NAT / SP RECT	9
800x1600 / 31½"x31½"	SP RECT	9
1200x1200 / 48"x48"	SP RECT	9
1200x2400 / 48"x96"	SP RECT	9
600x1200 / 24"x48"	SP RECT	6
1200x1200 / 48"x48"	NAT RECT	6
1200x2780 / 48"x110"	SP RECT	6
1600x1600 / 63"x63"	SP RECT	6
1600x3200 / 63"x126"	SP RECT	6
1620x3240 / 63¾"x127½"	SP NOT RECT	12
600x600 / 24"x24"	ST RECT	20
600x1200 / 24"x48"	ST RECT	20
800x800 / 31½"x31½"	ST RECT	20
1200x1200 / 48"x48"	ST RECT	20

Stucchi consigliati
Recommended grouts

KERAKOLL	35
MAPEI	112 Grigio Medio
LATICRETE	78 Sterling Silver

ABSOLUTE GC 06



Formati Nominali Nominal Sizes	Superficie Finish	Spessore mm Thickness mm
150x600 / 6"x24"	SP RECT	9
300x600 / 12"x24"	NAT / SP / ST RECT	9
600x600 / 24"x24"	NAT / SP / ST RECT	9
600x1200 / 24"x48"	NAT / SP / ST RECT	9
800x800 / 31½"x31½"	NAT / SP RECT	9
800x1600 / 31½"x31½"	SP RECT	9
1200x1200 / 48"x48"	SP RECT	9
600x1200 / 24"x48"	SP RECT	6
1200x1200 / 48"x48"	NAT RECT	6
1200x2780 / 48"x110"	SP RECT	6
600x600 / 24"x24"	ST RECT	20
600x1200 / 24"x48"	ST RECT	20
800x800 / 31½"x31½"	ST RECT	20
1200x1200 / 48"x48"	ST RECT	20

Stucchi consigliati
Recommended grouts

KERAKOLL	11
MAPEI	114 Antracite
LATICRETE	45 Raven

CHAMOIS GC 08

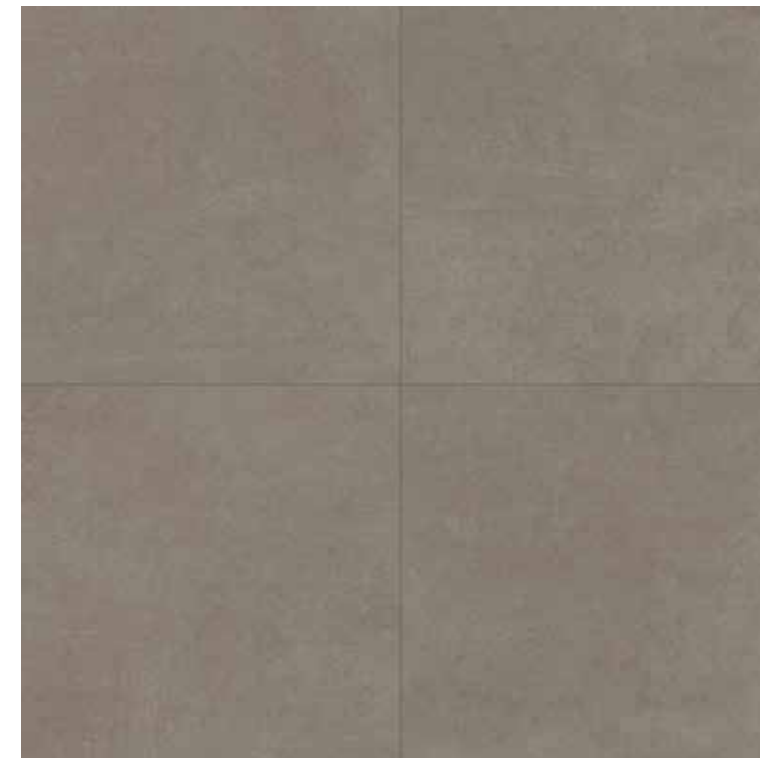

Formati Nominali Nominal Sizes	Superficie Finish	Spessore mm Thickness mm
150x600 / 6"x24"	SP RECT	9
300x600 / 12"x24"	NAT / SP / ST RECT	9
600x600 / 24"x24"	NAT / SP / ST RECT	9
600x600 / 24"x24"	SP RECT	20
600x1200 / 24"x48"	SP / NAT RECT	9
800x800 / 31½"x31½"	NAT / SP RECT	9
1200x1200 / 48"x48"	SP RECT	9
600x600 / 24"x24"	ST RECT	20
600x1200 / 24"x48"	ST RECT	20
800x800 / 31½"x31½"	ST RECT	20
1200x1200 / 48"x48"	ST RECT	20
600x600 / 24"x24"	ST RECT	30

Stucchi consigliati
Recommended grouts

KERAKOLL	46
MAPEI	112 Grigio Medio
LATICRETE	78 Sterling Silver

COLORI

Colours | Farben | Couleurs | Colores | Цветов | 种颜色

TOFFEE GC 09



Formati Nominali Nominal Sizes	Superficie Finish	Spessore mm Thickness mm
150x600 / 6"x24"	SP RECT	9
300x600 / 12"x24"	NAT / SP / ST RECT	9
600x600 / 24"x24"	NAT / SP / ST RECT	9
600x1200 / 24"x48"	SP / NAT RECT	9
800x800 / 31½"x31½"	NAT / SP RECT	9
1200x1200 / 48"x48"	SP RECT	9

Stucchi consigliati
Recommended grouts

KERAKOLL	36	
MAPEI	114 Antracite	
LATICRETE	45 Raven	

NEBULA GC 11

New

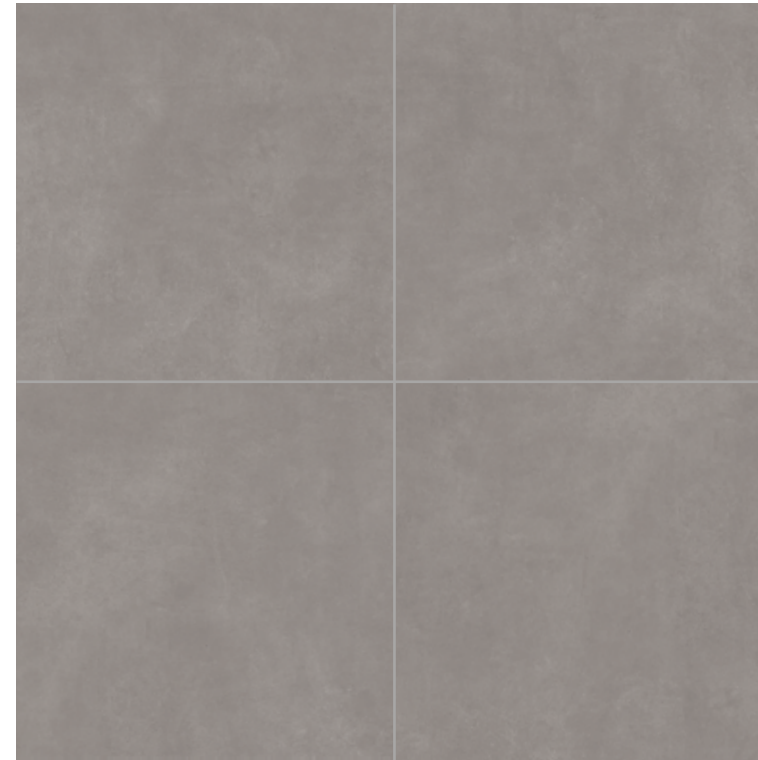

Formati Nominali Nominal Sizes	Superficie Finish	Spessore mm Thickness mm
150x600 / 6"x24"	SP RECT	9
300x600 / 12"x24"	NAT / SP / ST RECT	9
600x600 / 24"x24"	NAT / SP / ST RECT	9
600x1200 / 24"x48"	NAT / SP / ST RECT	9
800x800 / 31½"x31½"	NAT / SP RECT	9
1200x1200 / 48"x48"	SP RECT	9
1200x2780 / 48"x110"	SP RECT	6

Stucchi consigliati
Recommended grouts

KERAKOLL	35	
MAPEI	112 Grigio Medio	
LATICRETE	78 Sterling Silver	

GINGER GC 10

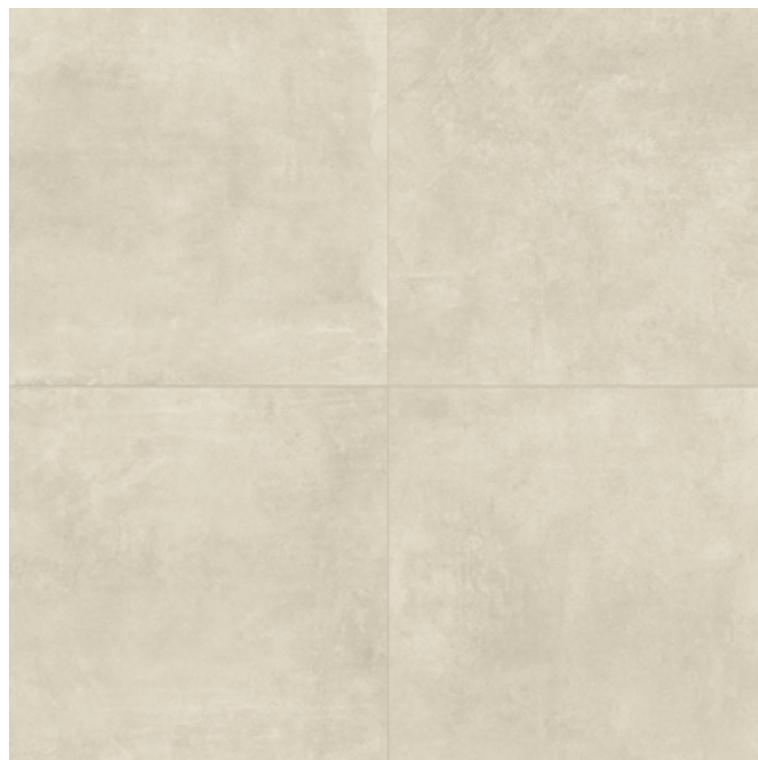

Formati Nominali Nominal Sizes	Superficie Finish	Spessore mm Thickness mm
150x600 / 6"x24"	SP RECT	9
300x600 / 12"x24"	NAT / SP / ST RECT	9
600x600 / 24"x24"	NAT / SP / ST RECT	9
600x1200 / 24"x48"	NAT / SP / ST RECT	9
800x800 / 31½"x31½"	NAT / SP RECT	9
800x1600 / 31½"x31½"	SP RECT	9
1200x1200 / 48"x48"	SP RECT	9
1200x2400 / 48"x96"	SP RECT	9
600x1200 / 24"x48"	SP RECT	6
1200x1200 / 48"x48"	NAT RECT	6
1200x2780 / 48"x110"	SP RECT	6
1600x1600 / 63"x63"	SP RECT	6
1600x3200 / 63"x126"	SP RECT	6
1620x3240 / 63¾"x127½"	SP NOT RECT	12

Stucchi consigliati
Recommended grouts

KERAKOLL	43	
MAPEI	111 Grigio Argento	
LATICRETE	88 Silver Shadow	

ESSENCE GC 12

New

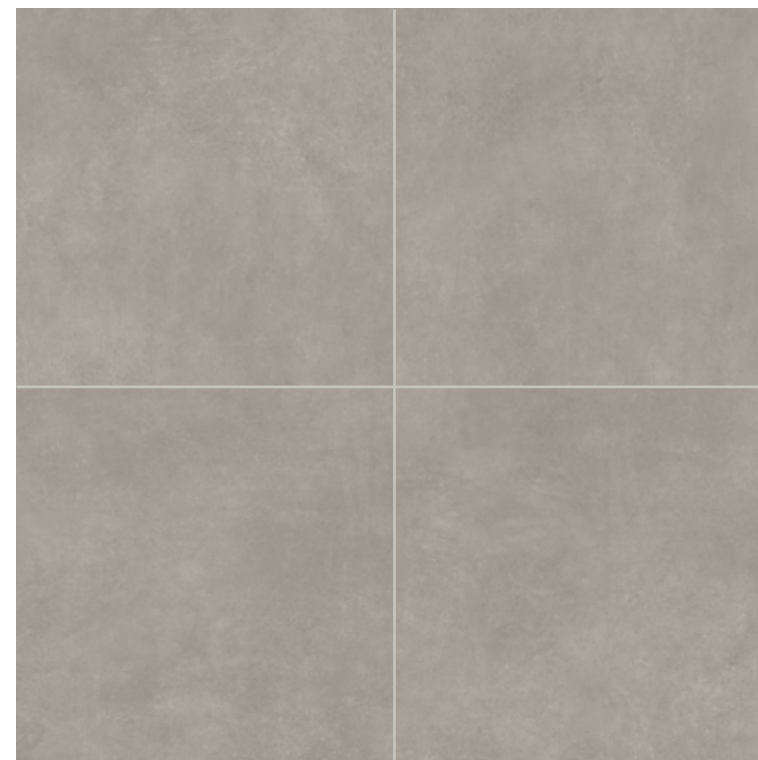

Formati Nominali Nominal Sizes	Superficie Finish	Spessore mm Thickness mm
150x600 / 6"x24"	SP RECT	9
300x600 / 12"x24"	NAT / SP / ST RECT	9
600x600 / 24"x24"	NAT / SP / ST RECT	9
600x1200 / 24"x48"	NAT / SP / ST RECT	9
800x800 / 31½"x31½"	NAT / SP RECT	9
1200x1200 / 48"x48"	SP RECT	9
1200x2780 / 48"x110"	SP RECT	6

Stucchi consigliati
Recommended grouts

KERAKOLL	06	
MAPEI	110 Manhattan	
LATICRETE	89 Smoke Grey	

COLORI

Colours | Farben | Couleurs | Colores | Цветов | 种颜色

JOURNEY GC 13

New

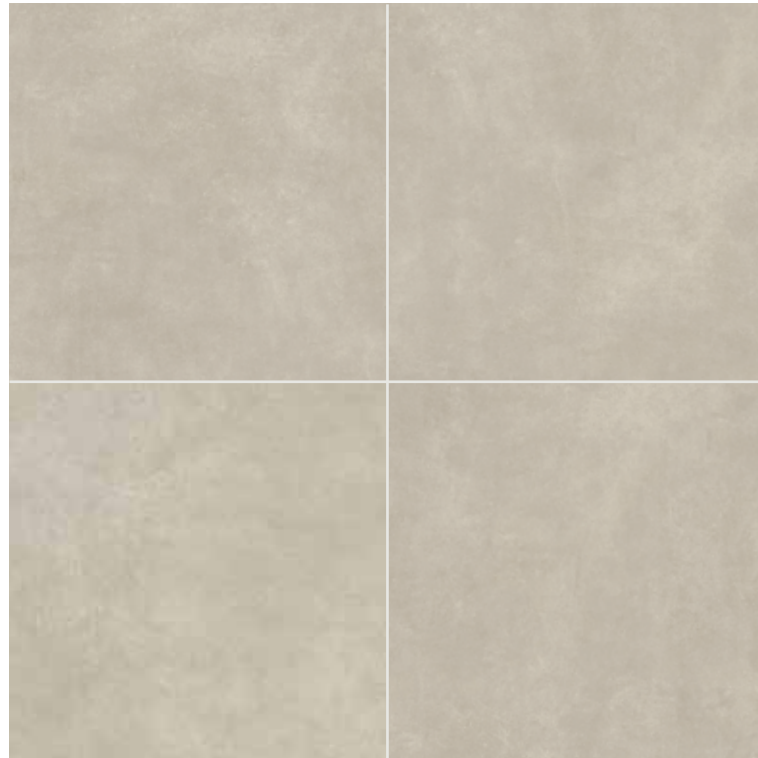

Formati Nominali Nominal Sizes	Superficie Finish	Spessore mm Thickness mm
150x600 / 6"x24"	SP RECT	9
300x600 / 12"x24"	NAT / SP / ST RECT	9
600x600 / 24"x24"	NAT / SP / ST RECT	9
600x1200 / 24"x48"	NAT / SP / ST RECT	9
800x800 / 31½"x31½"	NAT / SP RECT	9
1200x1200 / 48"x48"	SP RECT	9
1200x2780 / 48"x110"	SP RECT	6

Stucchi consigliati Recommended grouts		
KERAKOLL	05	
MAPEI	111 Grigio Argento	
LATICRETE	88 Silver Shadow	

YOUTH GC 15

New

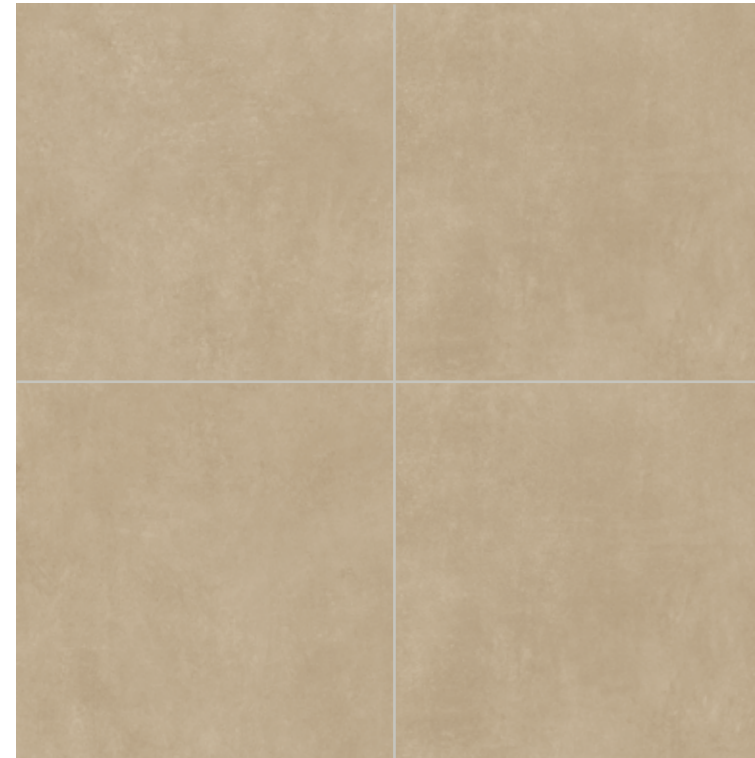

Formati Nominali Nominal Sizes	Superficie Finish	Spessore mm Thickness mm
150x600 / 6"x24"	SP RECT	9
300x600 / 12"x24"	NAT / SP / ST RECT	9
600x600 / 24"x24"	NAT / SP / ST RECT	9
600x1200 / 24"x48"	NAT / SP / ST RECT	9
800x800 / 31½"x31½"	NAT / SP RECT	9
800x1600 / 31½"x31½"	SP RECT	9
1200x1200 / 48"x48"	SP RECT	9
1200x2780 / 48"x110"	SP RECT	6
600x600 / 24"x24"	ST RECT	20
600x1200 / 24"x48"	ST RECT	20
800x800 / 31½"x31½"	ST RECT	20

Stucchi consigliati Recommended grouts		
KERAKOLL	06	
MAPEI	110 Manhattan	
LATICRETE	89 Smoke Grey	

SLIGHT GC 14

New

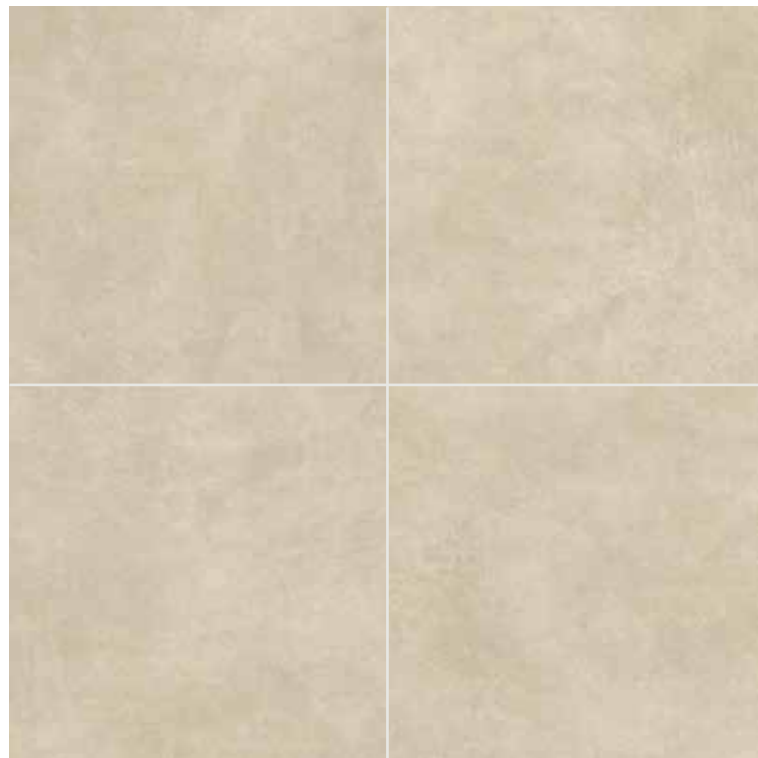

Formati Nominali Nominal Sizes	Superficie Finish	Spessore mm Thickness mm
150x600 / 6"x24"	SP RECT	9
300x600 / 12"x24"	NAT / SP / ST RECT	9
600x600 / 24"x24"	NAT / SP / ST RECT	9
600x1200 / 24"x48"	NAT / SP / ST RECT	9
800x800 / 31½"x31½"	NAT / SP RECT	9
800x1600 / 31½"x31½"	SP RECT	9
1200x1200 / 48"x48"	SP RECT	9
1200x2780 / 48"x110"	SP RECT	6
600x600 / 24"x24"	ST RECT	20
600x1200 / 24"x48"	ST RECT	20
800x800 / 31½"x31½"	ST RECT	20

Stucchi consigliati Recommended grouts		
KERAKOLL	05	
MAPEI	111 Grigio Argento	
LATICRETE	88 Silver Shadow	

HARMONY GC 16

New

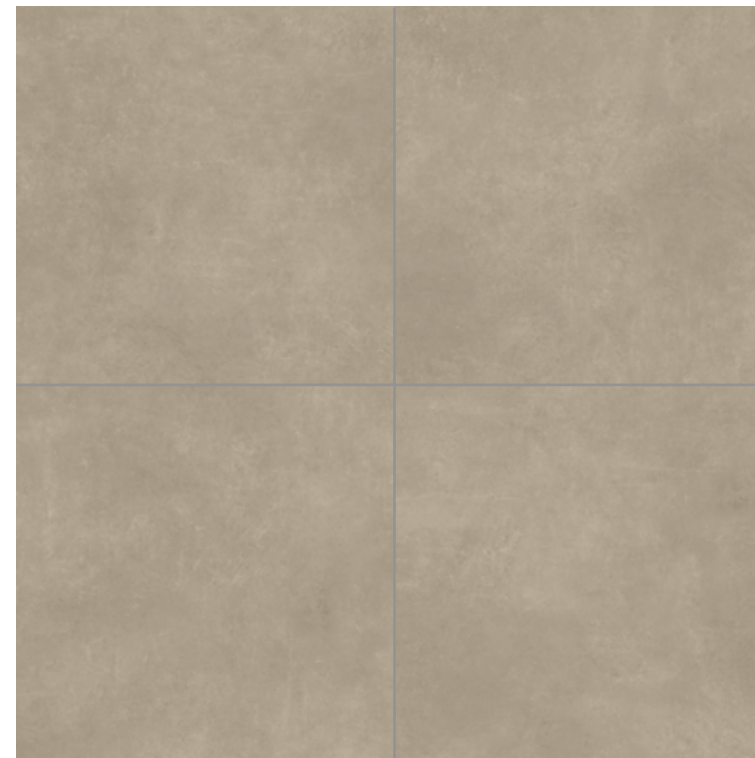

Formati Nominali Nominal Sizes	Superficie Finish	Spessore mm Thickness mm
150x600 / 6"x24"	SP RECT	9
300x600 / 12"x24"	NAT / SP / ST RECT	9
600x600 / 24"x24"	NAT / SP / ST RECT	9
600x1200 / 24"x48"	NAT / SP / ST RECT	9
800x800 / 31½"x31½"	NAT / SP RECT	9
1200x1200 / 48"x48"	SP RECT	9
600x600 / 24"x24"	ST RECT	20
600x1200 / 24"x48"	ST RECT	20
800x800 / 31½"x31½"	ST RECT	20

Stucchi consigliati Recommended grouts		
KERAKOLL	35	
MAPEI	112 Grigio Medio	
LATICRETE	78 Sterling Silver	

EFFETTO CEMENTO/RESINA

COLORI

Colours | Farben | Couleurs | Colores | Цветов | 种颜色

BRAVE GC 17

New

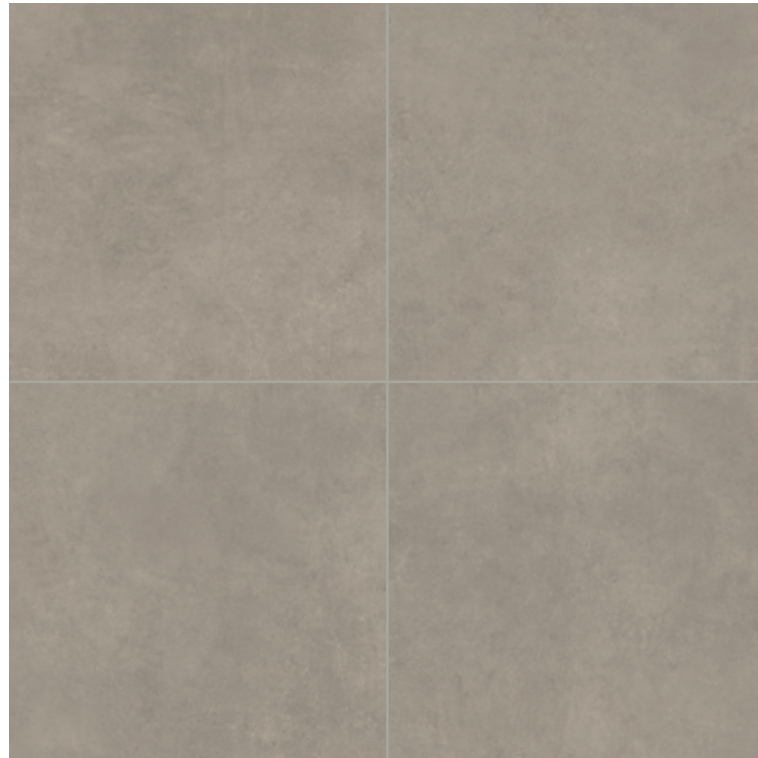

Formati Nominali Nominal Sizes	Superficie Finish	Spessore mm Thickness mm
150x600 / 6"x24"	SP RECT	9
300x600 / 12"x24"	NAT / SP / ST RECT	9
600x600 / 24"x24"	NAT / SP / ST RECT	9
600x1200 / 24"x48"	NAT / SP / ST RECT	9
800x800 / 31½"x31½"	NAT / SP RECT	9
1200x1200 / 48"x48"	SP RECT	9

Stucchi consigliati Recommended grouts	
KERAKOLL	35
MAPEI	112 Grigio Medio
LATICRETE	78 Sterling Silver



IRON GC 20



Formati Nominali Nominal Sizes	Superficie Finish	Spessore mm Thickness mm
150x600 / 6"x24"	SP RECT	9
300x600 / 12"x24"	SP RECT	9
600x600 / 24"x24"	SP RECT	9
600x1200 / 24"x48"	SP RECT	9
1200x2780 / 48"x110"	SP RECT	6
1600x1600 / 63"x63"	SP RECT	6
1600x3200 / 63"x126"	SP RECT	6

Stucchi consigliati Recommended grouts	
KERAKOLL	11
MAPEI	114 Antracite
LATICRETE	45 Raven



LUMINA GC 18

New



Formati Nominali Nominal Sizes	Superficie Finish	Spessore mm Thickness mm
150x600 / 6"x24"	SP RECT	9
300x600 / 12"x24"	NAT / SP RECT	9
600x600 / 24"x24"	NAT / SP RECT	9
600x1200 / 24"x48"	NAT / SP RECT	9
800x800 / 31½"x31½"	NAT / SP RECT	9
1200x1200 / 48"x48"	SP RECT	9
1200x2780 / 48"x110"	SP RECT	6

Stucchi consigliati Recommended grouts	
KERAKOLL	05
MAPEI	111 Grigio Argento
LATICRETE	88 Silver Shadow



CORTEN GC 21



Formati Nominali Nominal Sizes	Superficie Finish	Spessore mm Thickness mm
150x600 / 6"x24"	SP RECT	9
300x600 / 12"x24"	SP RECT	9
600x600 / 24"x24"	SP RECT	9
600x1200 / 24"x48"	SP RECT	9
1200x2780 / 48"x110"	SP RECT	6

Stucchi consigliati Recommended grouts	
KERAKOLL	28
MAPEI	113 Grigio Cemento
LATICRETE	34 Sand Stone



RIASSUNTIVO FORMATI ED IMBALLI

Summary of sizes and packaging | Übersicht über Formate und Verpackungen | Récapitulatif formats et emballages
Sinóptico de formatos y embalajes | Краткая информация о форматах и упаковках | 规格和包装概述

		± 9 mm								
Formati Nominali Nominal Sizes		300x300 12"x12"	150x600 6"x24"	300x600 12"x24"			600x600 24"x24"			
Tutti i formati sono rettificati. All sizes are rectified.										
Superficie Finish		NAT	SP	NAT	SP	ST	NAT	SP	ST	
CLEAR GC 01	V2	■	■	■	■	■	■	■	■	
PERFECT GC 02	V2	■	■	■	■	■	■	■	■	
IDEAL GC 03	V2	■	■	■	■	■	■	■	■	
TYPE GC 04	V2	-	■	■	■	■	■	■	■	
CLASSIC GC 05	V2	-	■	■	■	■	■	■	■	
ABSOLUTE GC 06	V2	-	■	■	■	■	■	■	■	
SUGAR GC 07	V2	-	■	■	■	■	■	■	■	
CHAMOIS GC 08	V2	-	■	■	■	■	■	■	■	
TOFFEE GC 09	V2	-	■	■	■	■	■	■	■	
GINGER GC 10	V2	-	■	■	■	■	■	■	■	
NEBULA GC 11	V2	-	■	■	■	■	■	■	■	
ESSENCE GC 12	V2	-	■	■	■	■	■	■	■	
JOURNEY GC 13	V2	-	■	■	■	■	■	■	■	
SLIGHT GC 14	V2	-	■	■	■	■	■	■	■	
YOUTH GC 15	V2	-	■	■	■	■	■	■	■	
HARMONY GC 16	V2	-	■	■	■	■	■	■	■	
BRAVE GC 17	V2	-	■	■	■	■	■	■	■	
LUMINA GC 18	V2	-	■	■	■	-	■	■	-	
IRON GC 20	V2	-	■	-	■	-	-	■	-	
CORTEN GC 21	V2	-	■	-	■	-	-	■	-	
Peso lordo per scatola Gross weight per box		22,50	26,92	25,58	25,58	25,40	22,13	22,12	22,12	
Pezzi per scatola Pieces for box		12	14	7	7	7	3	3	3	
mq. scatola sqm. box		1,08	1,26	1,26	1,26	1,26	1,08	1,08	1,08	
Scatole / Full pallet boxes / Full pallet		48	40	40	40	40	40	40	40	
mq. pallet sqm. pallet		51,84	50,40	50,40	50,40	50,40	43,20	43,20	43,20	

		± 9 mm										± 20 mm	
Formati Nominali Nominal Sizes		600x1200 24"x48"			800x800 31½"x31½"		800x1600 31½"x63"		1200x1200 48"x48"		1200x2400 48"x96"		600x600 24"x24"
Tutti i formati sono rettificati. All sizes are rectified.													
Superficie Finish		NAT	SP	ST	NAT	SP	SP	SP	SP	SP	SP	SP	
CLEAR GC 01	V2	■	■	■	■	■	■	■	■	■	■	■	■
PERFECT GC 02	V2	■	■	■	■	■	■	■	■	■	■	■	■
IDEAL GC 03	V2	■	■	■	■	■	■	■	■	■	■	■	■
TYPE GC 04	V2	■	■	-	■	■	-	■	■	-	■	■	-
CLASSIC GC 05	V2	■	■	-	■	■	-	■	■	-	■	■	■
ABSOLUTE GC 06	V2	■	■	■	■	■	■	■	■	-	■	■	-
SUGAR GC 07	V2	■	■	■	■	■	■	■	■	■	■	■	■
CHAMOIS GC 08	V2	■	■	-	■	■	-	■	■	-	■	■	■
TOFFEE GC 09	V2	■	■	-	■	■	-	■	■	-	■	■	-
GINGER GC 10	V2	■	■	■	■	■	■	■	■	■	■	■	-
NEBULA GC 11	V2	■	■	■	■	■	-	■	■	-	■	■	-
ESSENCE GC 12	V2	■	■	■	■	■	-	■	■	-	■	■	-
JOURNEY GC 13	V2	■	■	■	■	■	-	■	■	-	■	■	-
SLIGHT GC 14	V2	■	■	■	■	■	■	■	■	-	■	■	-
YOUTH GC 15	V2	■	■	■	■	■	■	■	■	-	■	■	-
HARMONY GC 16	V2	■	■	■	■	■	-	■	■	-	■	■	-
BRAVE GC 17	V2	■	■	■	■	■	-	■	■	-	■	■	-
LUMINA GC 18	V2	■	■	-	■	■	-	■	■	-	■	■	-
IRON GC 20	V2	-	■	-	-	-	-	-	-	-	-	-	-
CORTEN GC 21	V2	-	■	-	-	-	-	-	-	-	-	-	-
Peso lordo per scatola Gross weight per box		30,00	29,61	29,31	25,23	25,23	55,12	61,56					-
Pezzi per scatola Pieces for box		2	2	2	2	2	2	2					2
mq. scatola sqm. box		1,44	1,44	1,44	1,28	1,28	2,56	2,88					0,72
Scatole / Full pallet boxes / Full pallet		35	35	35	48	48	16	20					32
mq. pallet sqm. pallet		50,40	50,40	50,40	61,44	61,44	40,96	57,60					23,04

Per tutti i grandi formati è possibile prevedere, su richiesta, e con un lotto minimo l'applicazione di una stuoia in fibra di vetro.
For big sizes, a fibreglass mat can be applied on request, with a minimum production batch.

SP: Spazzolata

NAT: Naturale | Natural | Natur/unpoliert | Naturelle | Natural | Натуральный | 天然

ST: Strutturata | Structured | Strukturiert | Structuré | Estructurado | Труктурированный | 结构

RIASSUNTIVO FORMATI ED IMBALLI

Summary of sizes and packaging | Übersicht über Formate und Verpackungen | Récapitulatif formats et emballages
Sinóptico de formatos y embalajes | Краткая информация о форматах и упаковках | 规格和包装概述

		± 6 mm					± 12 mm
Formati Nominali Nominal Sizes		600x1200 24"x48"	1200x1200 48"x48"	1200x2780 48"x109"	1600x1600 63"x63"	1600x3200 63"x126"	1620x3240 63¾"x127½"
Tutti i formati sono rettificati, eccetto il formato 1620x3240. All sizes except 1620x3240 are rectified.							
Superficie Finish		NAT	SP	SP	SP	SP	SP
CLEAR GC 01	V2	■	■	■	■	■	■
PERFECT GC 02	V2	■	■	■	■	■	-
IDEAL GC 03	V2	■	■	■	■	■	■
TYPE GC 04	V2	-	-	-	-	-	-
CLASSIC GC 05	V2	-	-	-	-	-	-
ABSOLUTE GC 06	V2	■	■	■	-	-	-
SUGAR GC 07	V2	■	■	■	■	■	■
CHAMOIS GC 08	V2	-	-	-	-	-	-
TOFFEE GC 09	V2	-	-	-	-	-	-
GINGER GC 10	V2	■	■	■	■	■	■
NEBULA GC 11	V2	-	-	■	-	-	-
ESSENCE GC 12	V2	-	-	■	-	-	-
JOURNEY GC 13	V2	-	-	■	-	-	-
SLIGHT GC 14	V2	-	-	■	-	-	-
YOUTH GC 15	V2	-	-	■	-	-	-
HARMONY GC 16	V2	-	-	-	-	-	-
BRAVE GC 17	V2	-	-	-	-	-	-
LUMINA GC 18	V2	-	-	■	-	-	-
IRON GC 20	V2	-	-	■	■	■	-
CORTEN GC 21	V2	-	-	■	-	-	-
Peso lordo per scatola Gross weight per box		-	41,44				
Pezzi per scatola Pieces for box		3	2	Please refer to page 588	Please refer to page 588	Please refer to page 588	Please refer to page 588
mq. scatola sqm. box		2,16	2,88				
Scatole / Full pallet boxes / Full pallet		24	20				
mq. pallet sqm. pallet		51,84	57,60				

Per garantire elevati standard di sicurezza e le migliori performance tecniche in relazione al loro utilizzo finale (piani cucina, top, arredi), tutte le lastre in formato 1620x3240 in spessore 12mm prevedono l'applicazione di una stuoia in fibra di vetro sul retro della lastra.
All the 1620x3240 slabs in 12mm thickness are provided with a fiberglass mat applied to the back of the slab, to guarantee substantial safety standards and suitable technical performance required for their final use (kitchen countertops, tops, furnishings).

Per tutti i grandi formati è possibile prevedere, su richiesta, e con un lotto minimo l'applicazione di una stuoia in fibra di vetro.
For big sizes, a fiberglass mat can be applied on request, with a minimum production batch.

ACCORGIMENTI SPECIFICI PER L'APPLICAZIONE DELLE GRANDI LASTRE IN 6 MM DI SPESSORE: p. 582 | Precautions for 6mm big slabs applications: page 582 | spezifische Anweisungen zur Nutzung der Grossformate in 6mm: seite 582 | Precauciones específicas para la aplicación de las grandes placas en 6 mm de espesor: page 582 | Precautions spécifiques pour la pose des grandes plaques en 6mm d'épaisseur: página 582 | специальные предосторожности для укладки больших плит толщиной 6 мм : страница 582

RACCOMANDAZIONI PER UTILIZZO E CURA DELLE LASTRE COUNTERTOPS p. 583 | How to use and take good care of the COUNTERTOPS slabs p. 583 | Tipps für den Einsatz und die Pflege der Platten COUNTERTOPS p. 583 | Recommendations pour l'utilisation et le soin des plaques COUNTERTOPS p.583 | Recomendaciones para el uso y cuidado de las placas COUNTERTOPS p. 583 | Рекомендации по использованию и уходу за плитami COUNTERTOPS p.583 | 规格的COUNTERTOPS系列陶瓷板的使用和护理建议 583

		± 20 mm				± 30 mm
Formati Nominali Nominal Sizes		600x600 24"x24"	600x1200 24"x48"	800x800 31½"x31½"	1200x1200 48"x48"	600x600 24"x24"
Tutti i formati sono rettificati. All sizes are rectified.						
Superficie Finish		ST	ST	ST	ST	ST
PERFECT GC 02	V2	■	■	■	■	-
IDEAL GC 03	V2	■	■	■	■	■
TYPE GC 04	V2	■	■	■	■	■
CLASSIC GC 05	V2	■	■	■	■	■
ABSOLUTE GC 06	V2	■	■	■	■	-
SUGAR GC 07	V2	■	■	■	■	-
CHAMOIS GC 08	V2	■	■	■	■	■
SLIGHT GC 14	V2	■	■	■	-	-
YOUTH GC 15	V2	■	■	■	-	-
HARMONY GC 16	V2	■	■	■	-	-
Peso lordo per scatola Gross weight per box		31,15	32,00	28,50	Please refer to page 588	23,60
Pezzi per scatola Pieces for box		2	1	1		1
mq. scatola sqm. box		0,72	0,72	0,64		0,36
Scatole / Full pallet boxes / Full pallet		30	35	42		40
mq. pallet sqm. pallet		21,60	25,20	26,88		14,40

SP: Spazzolata

NAT: Naturale | Natural | Natur/unpoliert | Naturelle | Natural | Натуральный | 天然

ST: Strutturata | Structured | Strukturiert | Structuré | Estructurado | Труктурированный | 结构

PEZZI SPECIALI

Special pieces | Sonderstücke | Pièces spéciales | Piezas especiales | специальные изделия | 特殊件

Pezzi speciali Special pieces	Battiscopa*		Gradino A*		Gradino A*		Gradino A*		Gradino G*		Gradino G*	
	72x600 27/8"x24"	72x800 27/8"x31 1/2"	300x600 12"x24"		330x800 13 1/8"x31 1/2"		330x1200 13 1/8"x48"		300x600 12"x24"		330x800 13 1/8"x31 1/2"	
Superficie Finish	SP	SP	NAT	SP	NAT	SP	NAT	SP	NAT	SP	NAT	SP
CLEAR GC 01	■	■	■	■	■	■	■	■	■	■	■	■
PERFECT GC 02	■	■	■	■	■	■	■	■	■	■	■	■
IDEAL GC 03	■	■	■	■	■	■	■	■	■	■	■	■
TYPE GC 04	■	■	■	■	■	■	■	■	■	■	■	■
CLASSIC GC 05	■	■	■	■	■	■	■	■	■	■	■	■
ABSOLUTE GC 06	■	■	■	■	■	■	■	■	■	■	■	■
SUGAR GC 07	■	■	■	■	■	■	■	■	■	■	■	■
CHAMOIS GC 08	■	■	■	■	■	■	■	■	■	■	■	■
TOFFEE GC 09	■	■	■	■	■	■	■	■	■	■	■	■
GINGER GC 10	■	■	■	■	■	■	■	■	■	■	■	■
NEBULA GC 11	■	■	■	■	■	■	■	■	■	■	■	■
ESSENCE GC 12	■	■	■	■	■	■	■	■	■	■	■	■
JOURNEY GC 13	■	■	■	■	■	■	■	■	■	■	■	■
SLIGHT GC 14	■	■	■	■	■	■	■	■	■	■	■	■
YOUTH GC 15	■	■	■	■	■	■	■	■	■	■	■	■
HARMONY GC 16	■	■	■	■	■	■	■	■	■	■	■	■
BRAVE GC 17	■	■	■	■	■	■	■	■	■	■	■	■
LUMINA GC 18	■	■	■	■	■	■	■	■	■	■	■	■
IRON GC 20	■	■	-	■	-	■	-	■	-	■	-	■
CORTEN GC 21	■	■	-	■	-	■	-	■	-	■	-	■
Pezzi per scatola Pieces for box	10		7		7		4		7		7	

* Finitura a becco di civetta | One-round edge shaping | Ausführung mit Eckabrundung | Façonnage à bord rond | Acabado canto romo | Плитка с завалом | 鹰嘴边缘处理

Pezzi speciali Special pieces	Gradino B ang.		Gradino B		Gradino B		Gradino B		Unico 2.0	Copertina 2.0
	330x330 13 1/8"x13 1/8"	330x600 13 1/8"x24"	330x800 13 1/8"x31 1/2"	330x1200 13 1/8"x48"	300x600x20 12"x24"x3/4"	300x600x20 12"x24"x3/4"				
Superficie Finish	NAT	SP	NAT	SP	NAT	SP	NAT	SP	ST	ST
CLEAR GC 01	■	■	■	■	■	■	-	-	-	-
PERFECT GC 02	■	■	■	■	■	■	-	-	-	-
IDEAL GC 03	■	■	■	■	■	■	■	■	■	■
TYPE GC 04	■	■	■	■	■	■	■	■	■	■
CLASSIC GC 05	■	■	■	■	■	■	■	■	-	-
ABSOLUTE GC 06	■	■	■	■	■	■	■	■	■	■
SUGAR GC 07	■	■	■	■	■	■	■	■	-	-
CHAMOIS GC 08	■	■	■	■	■	■	■	■	■	-
TOFFEE GC 09	■	■	■	■	■	■	■	■	-	-
GINGER GC 10	■	■	■	■	■	■	■	■	-	-
NEBULA GC 11	■	■	■	■	■	■	■	■	-	-
ESSENCE GC 12	■	■	■	■	■	■	■	■	-	-
JOURNEY GC 13	■	■	■	■	■	■	■	■	-	-
SLIGHT GC 14	■	■	■	■	■	■	■	■	-	-
YOUTH GC 15	■	■	■	■	■	■	■	■	-	-
HARMONY GC 16	■	■	■	■	■	■	■	■	-	-
BRAVE GC 17	■	■	■	■	■	■	■	■	-	-
LUMINA GC 18	■	■	■	■	■	■	■	■	-	-
IRON GC 20	-	■	-	■	-	■	-	■	-	-
CORTEN GC 21	-	■	-	■	-	■	-	■	-	-
Pezzi per scatola Pieces for box	4		4		4		2		3	3

MY NOTES

.....

.....

.....

.....

.....

Maggiori informazioni
More information



SP: Spazzolata

NAT: Naturale | Natural | Natur/unpoliert | Naturelle | Natural | Натуральный | 天然

ST: Strutturata | Structured | Strukturiert | Structuré | Estructurado | Труктурированный | 结构

DECORI

Decors | Dekore | Decors | Decoros | Декоры | 装饰砖

Cube
150x150 / 6"x6"



BLUE
CLEAR GC 01



RED
GINGER GC 10



ORANGE
PERFECT GC 02



YELLOW
ESSENCE GC 12



TURQUOISE
JOURNEY GC 13



GREEN
NEBULA GC 11



BROWN
ABSOLUTE GC 06

Mosaico Color
300x300 / 12"x12"
Tessere 48x48 / 2"x2"



BLUE

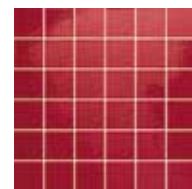

RED

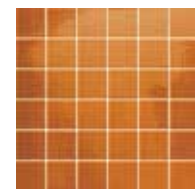

ORANGE



YELLOW

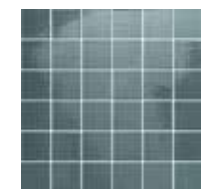

TURQUOISE

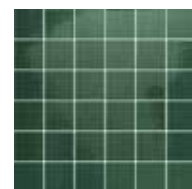

GREEN

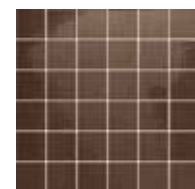

BROWN

Board
600x600 / 24"x24"



YOUTH GC 15

Depot SP
600x600 / 24"x24"



IRON GC 20

Skin
1200x2780 / 48"x110"

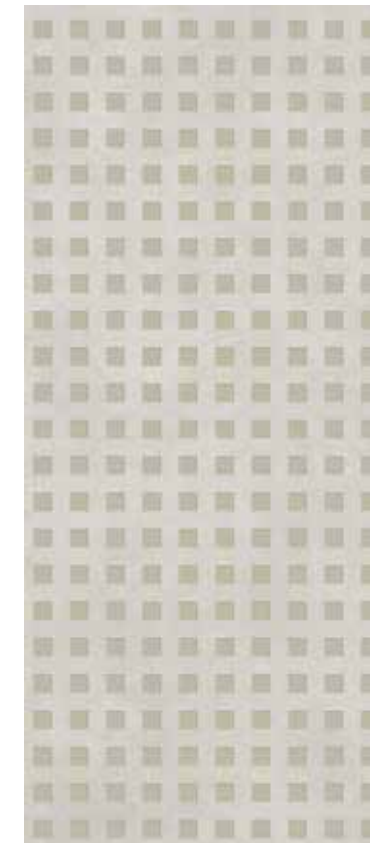

CLEAR GC 01



GINGER GC 10



PERFECT GC 02

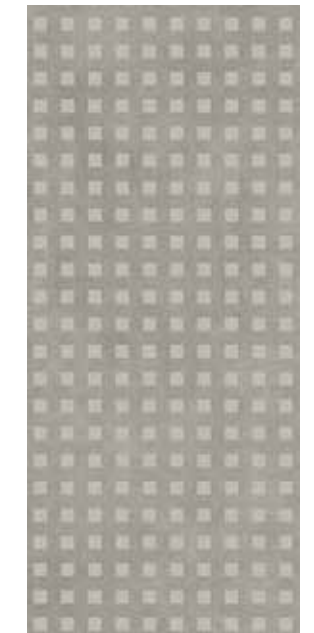

ESSENCE GC 12



JOURNEY GC 13



NEBULA GC 11

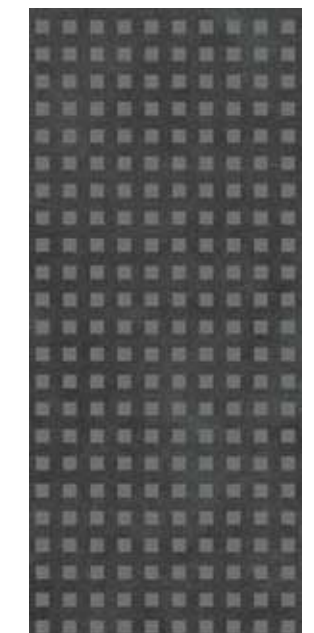

ABSOLUTE GC 06

MOSAICO COLOR:
Decoro su rete | Mesh-backed decoration | Dekor auf netz | Décor sur filet | Decoración en red | Декор в сетку | 网板背帖装饰件

CUBE, MOSAICO COLOR, BOARD:
Adatti esclusivamente per applicazione a rivestimento | Decorations for wall use only

SKIN:
Adatti esclusivamente per applicazione a rivestimento | Decorations for wall use only

DECORI

Decors | Dekore | Decors | Decoros | Декоры | 装饰砖

 **Globe**
600x600 / 24"x24"

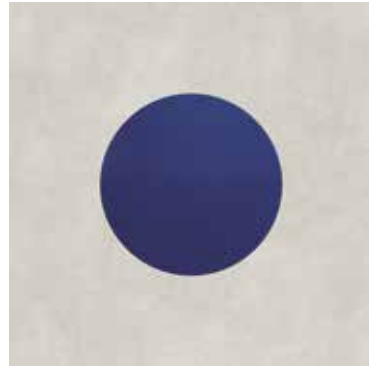

BLUE
CLEAR GC 01

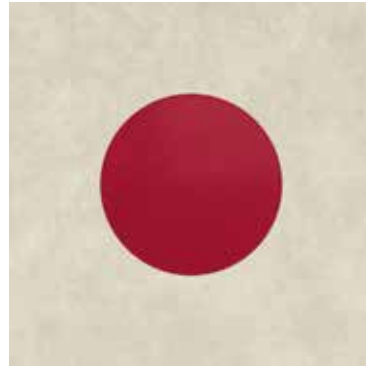

RED
GINGER GC 10

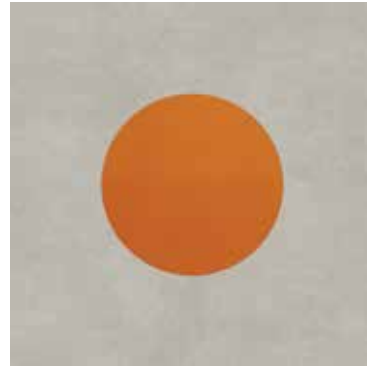

ORANGE
PERFECT GC 02

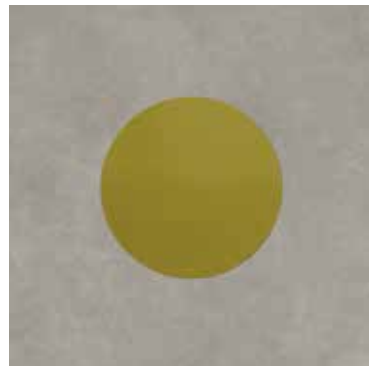

YELLOW
ESSENCE GC 12

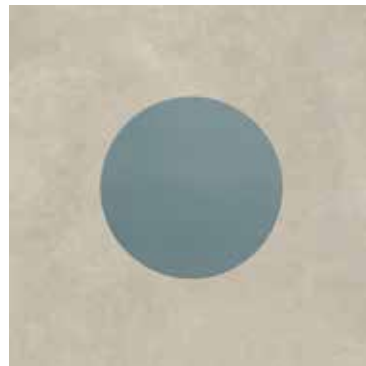

TURQUOISE
JOURNEY GC 13

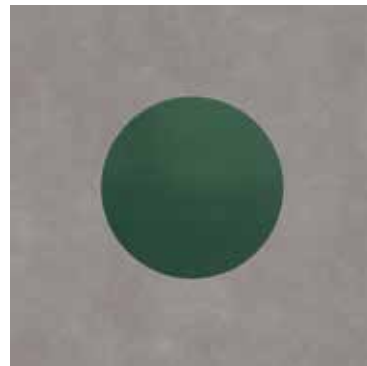

GREEN
NEBULA GC 11



BROWN
ABSOLUTE GC 06

GLOBE:
Adatti esclusivamente per applicazione a rivestimento | Decorations for wall use only

 **Globe Skin**
600x600 / 24"x24"

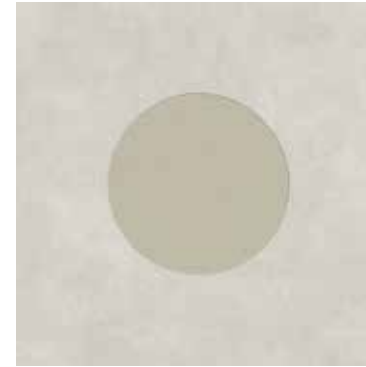

CLEAR GC 01

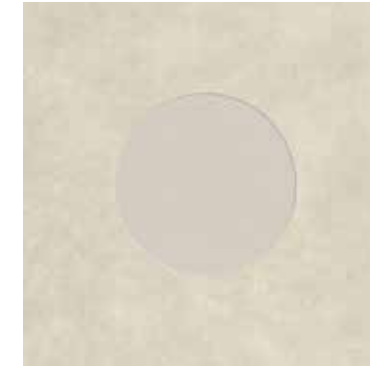

GINGER GC 10

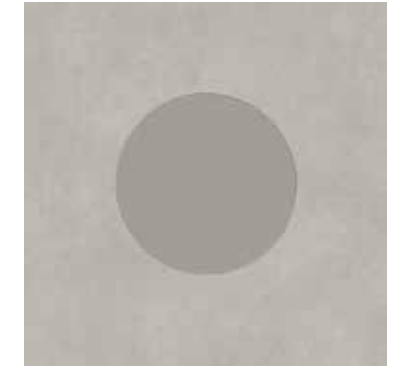

PERFECT GC 02

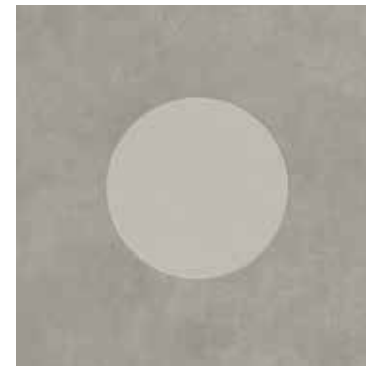

ESSENCE GC 12

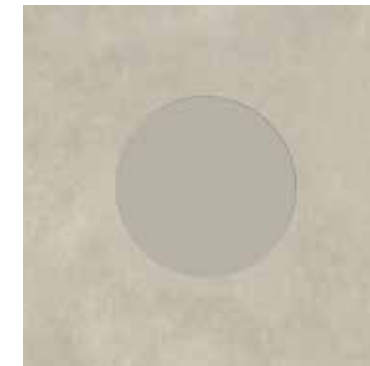

JOURNEY GC 13



NEBULA GC 11

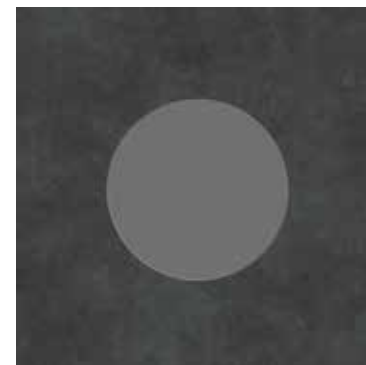

ABSOLUTE GC 06

GLOBE SKIN:
Adatti esclusivamente per applicazione a rivestimento | Decorations for wall use only

DECORI

Decors | Dekore | Decors | Decoros | Декоры | 装饰砖

 **Mosaico 36T NAT**
300x300 / 12"x12"
Tessere 48x48 / 2"x2"

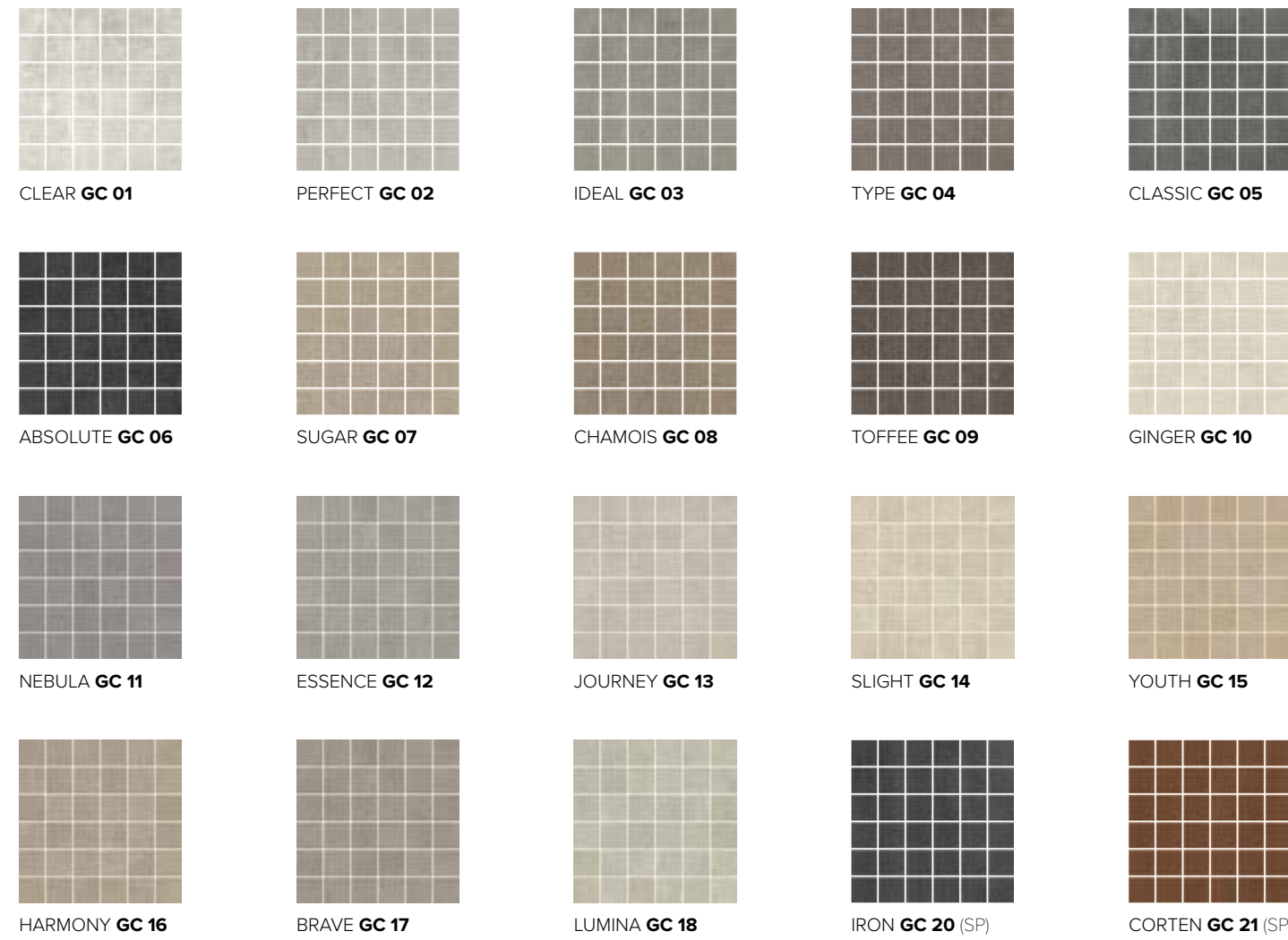

 **Mattoncino NAT**
300x300 / 12"x12"
Tessere 24x48 / 1"x2"

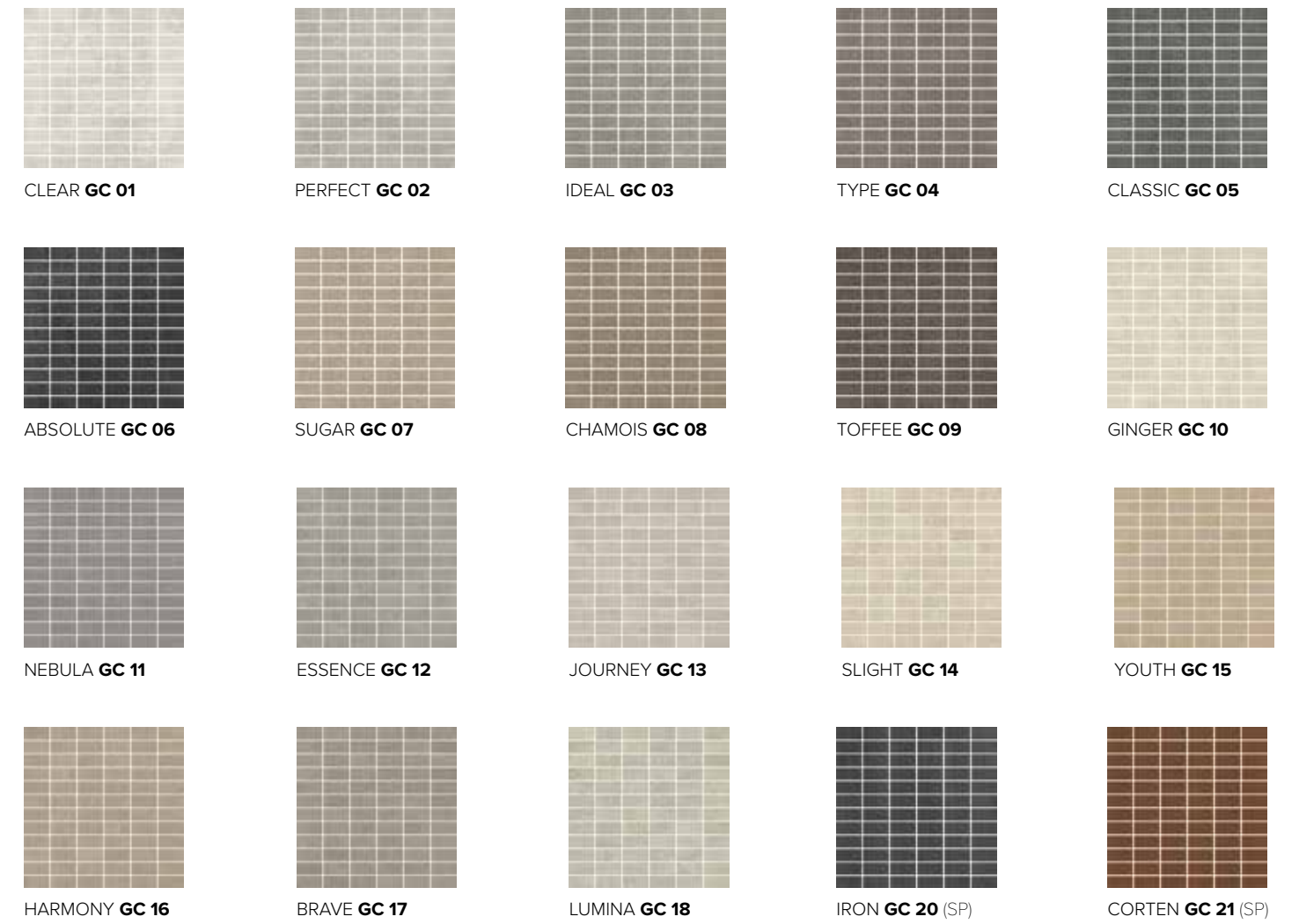

 **Knit NAT**
300x300 / 12"x12"
Tessere 24x48 / 1"x2"

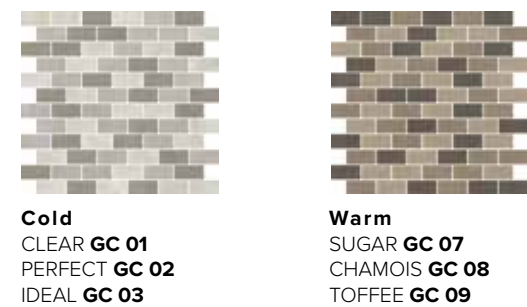

 **Ensemble NAT**
300x300 / 12"x12"



 Pezzi per scatola	
Pieces for box	
Mattoncino	6
Mosaico 36T	6
Knit	6
Ensemble	12
Depot	3
Mosaico Color	6
Cube	8
Globe	2
Globe Skin	2
Skin	-
Board	2
Boule	1
Sun	1
Writer	1

EFFETTO CEMENTO/RESINA

I DECORATI 800x800x20 mm

800x800x20 mm decorated tiles | Die dekorierten Fliesen 800x800x20 mm | Les décorés 800x800x20 mm
Azulejos decorados 800x800x20 mm | Декоры 800x800x20 mm | 装饰砖 800x800x20 mm

BOULE (FREDDO) ST 20mm

800x800x20 / 31½"x31½"x¾"

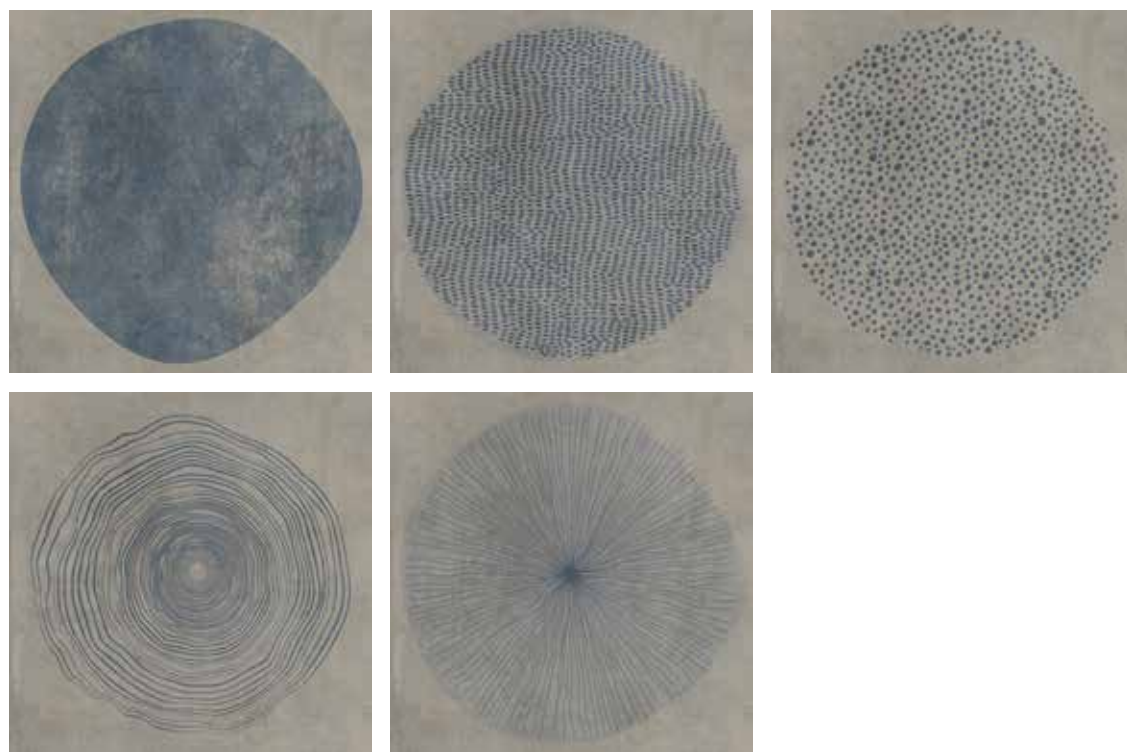

IDEAL GC 03 5 grafiche - 5 graphics

BOULE (FREDDO) ST 20mm

800x800x20 / 31½"x31½"x¾"



IDEAL GC 03 5 grafiche - 5 graphics

GLOCAL

SUN ST 20mm

800x800x20 / 31½"x31½"x¾"



PERFECT GC 02 6 grafiche - 6 graphics

WRITER ST 20mm

800x800x20 / 31½"x31½"x¾"



IDEAL GC 03 8 grafiche - 8 graphics

BOULE, SUN E WRITER: grafiche miscelate in modo casuale.
BOULE, SUN AND WRITER: graphics mixed randomly.



FLOOR: Type **GC 04** 600x600 / 24"x24" SP RECT
 WALL: Nebula **GC 11** 1200x2780 / 48"x110" SP RECT

CARATTERISTICHE TECNICHE

Technical specifications | Technische Eigenschaften | Caractéristiques techniques | Características técnicas | Технические характеристики | 技术特征

STANDARD EN 14411 - G

	CARATTERISTICHE TECNICHE TECHNICAL DATA TECHNISCHE DATEN CARACTERISTIQUES TECHNIQUES CARACTERÍSTICAS TÉCNICAS ТЕХНИЧЕСКИЕ ХАРАКТЕРИСТИКИ 技术特征	NORMA STANDARD NORM NORME NORMA ЗНАЧЕНИЯ 标准	VALORI PRESCRITTI DALLE NORME EN 14411 - G INTERNATIONAL STANDARDS EN 14411 - G INTERNATIONALE NORMWERTE EN 14411 - G VALEURS PREVUES PAR LES NORMES EN 14411 - G VALORES PREVISTOS POR LAS NORMAS EN 14411 - G ПРЕДУСМОТРЕННЫЕ СТАНДАРТОМ EN 14411-G EN 14411 - G标准规定值	*VALORE MEDIO MIRAGE MIRAGE AVERAGE VALUE MIRAGE MITTELWERT VALEURS MOYEN MIRAGE VALOR MEDIO MIRAGE СРЕДНЕЕ ЗНАЧЕНИЕ MIRAGE MIRAGE平均值
	CARATTERISTICHE DIMENSIONALI - SIZE CHARACTERISTICS - MASSEIGENSCHAFTEN DETERMINATION DES CARACTERISTIQUES DIMENSIONNELLES - CARACTERÍSTICAS DIMENSIONALES - РАЗМЕРНЫЕ ХАРАКТЕРИСТИКИ - 尺寸特征			
	LATI SIDES - SEITEN COTES - CANTOS РАЗМЕРЫ СТОРОН - 側邊	EN ISO 10545-2	± 0,3% MAX (± 1,0 mm MAX)	CONFORME COMPLYING
	SPESSORE THICKNESS - DICKE ÉPAISSEUR - ESPESOR ТОЛЩИНА - 厚度	EN ISO 10545-2	± 5,0% MAX (± 0,5 mm MAX)	CONFORME COMPLYING
	RETTILINEITÀ DEGLI SPIGOLI STRAIGHTNESS OF SIDES - GERADLINIGKEIT DER KANTEN RECTITUDE DES ARETES - RECTITUD DE LOS CANTOS КОСОУГОЛЬНОСТЬ - 边角平直度	EN ISO 10545-2	± 0,3% MAX (± 0,8 mm MAX)	CONFORME COMPLYING
	ORTOGONALITÀ RECTANGULARITY - RECHTWINKLIGKEIT PERPENDICULARITÉ - ORTOGONALIDAD КРИВИЗНА СТОРОН - 直角度	EN ISO 10545-2	± 0,3% MAX (± 1,5 mm MAX)	CONFORME COMPLYING
	PLANARITÀ SURFACE FLATNESS - EBENFLÄCHIGKEIT PLANEITE DE SURFACE - PLANEIDAD КРИВИЗНА ЛИЦЕВОЙ ПОВЕРХНОСТИ - 平整度	EN ISO 10545-2	± 0,4% MAX (± 1,8 mm MAX)	CONFORME COMPLYING
	ASSORBIMENTO D'ACQUA WATER ABSORPTION - WASSERAUFNAHME ABSORPTION D'EAU - ABSORCIÓN DE AGUA ВОДОПОГЛОЩЕНИЕ - 吸水率	EN ISO 10545-3	≤ 0,5%	≤ 0,1%
	RESISTENZA ALLA FLESSIONE FLEXION RESISTANCE - BIEGEFESTIGKEIT RESISTANCE A LA FLEXION - RESISTENCIA A LA FLEXIÓN ПРЕДЕЛ ПРОЧНОСТИ ПРИ ИЗГИБЕ - 抗弯强度	EN ISO 10545-4	S ≥ 700 N (< 7,5 mm) S ≥ 1.300 N (> 7,5 mm) R ≥ 35 N/mm ² .	±6 mm: S≥1100N R≥45 N/mm ² ±9 mm: S≥2.400N R≥48 N/mm ² ±12 mm: S≥4.000N R≥48 N/mm ² ±20 mm: S≥12.500N R≥48 N/mm ² ±30 mm: S≥26.000N R≥48 N/mm ²
	RESISTENZA ALL'URTO IMPACT RESISTANCE - STOSSFESTIGKEIT RESISTANCE AUX CHOCES - RESISTENCIA A LOS GOLPES УДАРОСТОЙКОСТЬ - 抗冲击强度	EN ISO 10545-5	VALORE DICHIARATO DECLARED VALUE	> 0,80
	RESISTENZA ALL'ABRAZIONE ABRASION RESISTANCE - ABRIEFESTIGKEIT RESISTANCE A L'ABRASION - RESISTENCIA A LA ABRASIÓN СТОЙКОСТЬ К ИСТИРАНИЮ - 耐磨强度	EN ISO 10545-6	≤ 175 mm ³	< 150 mm ³
	COEFFICIENTE DI DILATAZIONE TERMICA LINEARE COEFFICIENT OF LINEAR THERMAL-EXPANSION - LINEARER WÄRMEAUSSDEHNUNGSKOEFFIZIENT COEFFICIENT DE DILATATION THERMIQUE LINEAIRE - COEFICIENTE DE DILATACIÓN TÉRMICA LINEAL КОЭФФИЦИЕНТ ЛИНЕЙНОГО ТЕРМИЧЕСКОГО РАСТЯЖЕНИЯ - 线性热膨胀系数	EN ISO 10545-8	-	α=6,6x10 ⁻⁶ °C ⁻¹
	RESISTENZA AGLI SBALZI TERMICI RESISTANCE TO THERMAL SHOCKS - BESTÄNDIGKEIT GEGEN TEMPERATURSCHWANKUNGEN RESISTANCE AUX CHOCES THERMIQUES - RESISTENCIA A LOS CHOQUES TÉRMICOS СТОЙКОСТЬ К ПЕРЕПАДАМ ТЕМПЕРАТУРЫ - 耐热突变性	EN ISO 10545-9	TEST SUPERATO SECONDO EN ISO 10545-1 PASS ACCORDING EN ISO 10545-1	NESSUN DANNO NO DAMAGE
	RESISTENZA AL GELO FROST RESISTANCE - FROSTBESTÄNDIGKEIT RESISTANCE AU GEL - RESISTENCIA AL HIELO МОРОЗОСТОЙКОСТЬ - 耐冻性	EN ISO 10545-12	TEST SUPERATO SECONDO EN ISO 10545-1 PASS ACCORDING EN ISO 10545-1	NESSUN DANNO NO DAMAGE
	RESISTENZA ALL'ATTACCO CHIMICO RESISTANCE TO CHEMICALS - CHEMIKALIENBESTÄNDIGKEIT RESISTANCE A L'ATTAQUE CHIMIQUE - RESISTENCIA QUÍMICA ХИМИЧЕСКАЯ СТОЙКОСТЬ - 耐化学品作用	EN ISO 10545-13	UB MIN.	A LA HA
	RESISTENZA ALLE MACCHIE RESISTANCE TO STAINS - FLECKENBESTÄNDIGKEIT RESISTANCE AUX TACHES - RESISTENCIA A LAS MANCHAS УСТОЙЧИВОСТЬ К ПЯТНООБРАЗОВАНИЮ - 防污性	EN ISO 10545-14	VALORE DICHIARATO DECLARED VALUE	5
	CESSIONE DI PIOMBO E CADMIO LEAD AND CADMIUM DISCHARGE - ABGABE VON BLEI UND CADMIUM PERTE DE PLOMB ET CADMIUM - CESIÓN DE PLOMO Y CADMIO ВЫДЕЛЕНИЕ СВИНЦА И КАДМИЯ - 铅和镉的排放	EN ISO 10545-15	VALORE DICHIARATO DECLARED VALUE	< AL LIMITE DI RILEVAMENTO < THAN INSTRUMENT LIMIT
				NAT ST SP ST 20/30mm
	DM 236/89 BCRA		> 0,40	> 0,40 > 0,40 > 0,40
	ANSI A326.3		Wet and Dry	≥ 0,42 ≥ 0,55 ≥ 0,42 ≥ 0,55
	AS 4586		-	P2 P5 P2 P5
	DIN 51130		-	R10 R11 R9 R11
	DIN 51097		-	A A+B+C A A+B+C
	UNE 41901		≥ CL1	CL2 CL3 CL1 CL3
	BS 7976 sl.96-4S		Wet and Dry	≥ 0,36 ≥ 0,36 - ≥ 0,36
	BS 7976 sl.55-TRL		Wet and Dry	- ≥ 0,36 - ≥ 0,36
	SCIVOLOSITÀ SKID RESISTANCE - RUTSCHWERT GLISSANCE - ADHERENCIA СКОЛЬЗКОСТЬ - 防滑性			

Per i certificati specifici, contattare Mirage SpA - For specific certificates, please contact Mirage SpA - Für die speziellen Zertifikate wenden Sie sich bitte an Mirage SpA - Pour les certificats spécifiques, veuillez contacter Mirage SpA
 Para los certificados específicos, contactar Mirage SpA - Для сертификатов обращайтесь в компанию Mirage SpA - 关于具体的证书, 请联系Mirage SpA公司



WALL: Moonless **JW 17** 1200x2780 / 48"x110" LUC RECT
FLOOR: JURUPA Camp **JP 04** 200x1200 / 8"x48" NAT RECT

JEWELS

The authentic expression of the most **PRECIOUS** natural stone, Jewels is an exclusive collection of marbles used historically in architecture.

Porcelain stoneware for floors and walls, combining aesthetic excellence with the quality of porcelain stoneware, for classic and contemporary settings with an timeless charm.



JW 02 Calacatta Reale 600x600/ 24"x24" LUC RECT



FLOOR: Onyx **JW 15** 1600x1600 / 63"x63" LUC RECT
 WALL: Onyx **JW 15** 1600x3200 / 63"x126" LUC RECT
 WASHBASIN: BATHMOOD Wish **JW 15** LUC + BATHMOOD Round Bliss Mirror

COLORI

Colours | Farben | Couleurs | Colores | Цветов | 种颜色

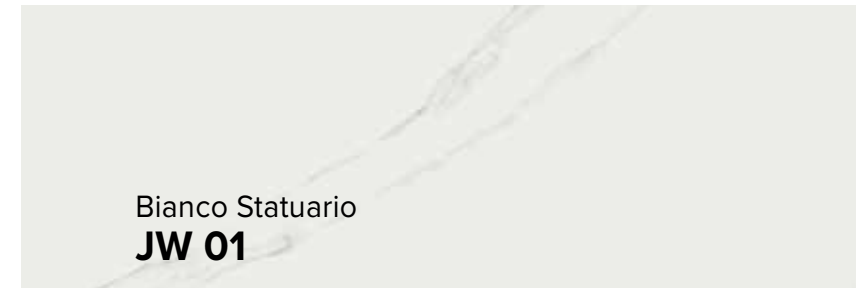

Bianco Statuario
JW 01



Calacatta Reale
JW 02



Royal
JW 03

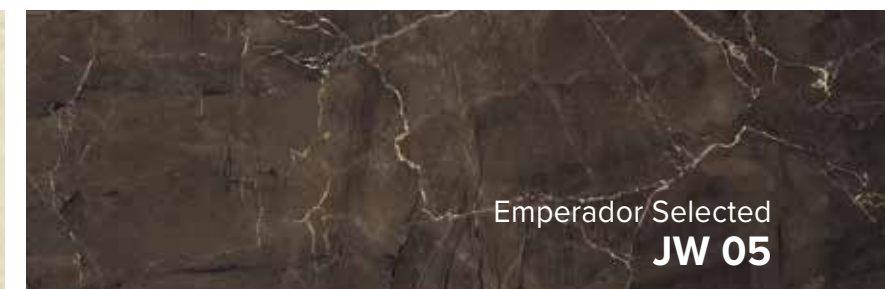

Emperador Selected
JW 05

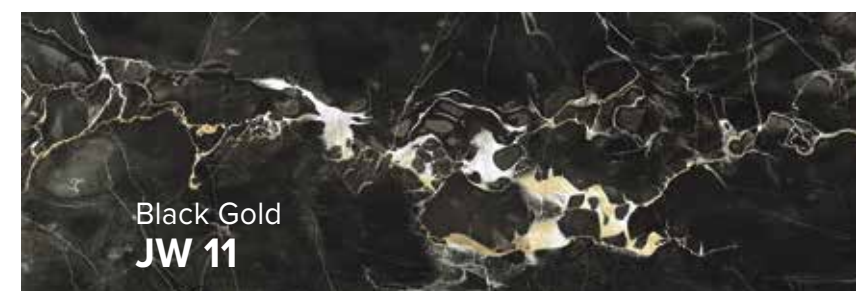

Black Gold
JW 11

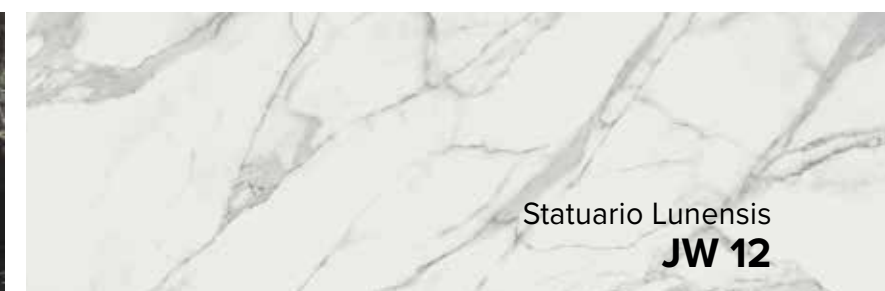

Statuario Lunensis
JW 12

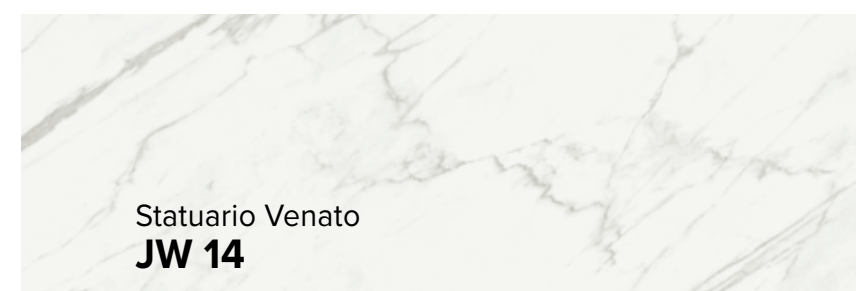

Statuario Venato
JW 14



Onyks
JW 15



Raymi
JW 16



Moonless
JW 17

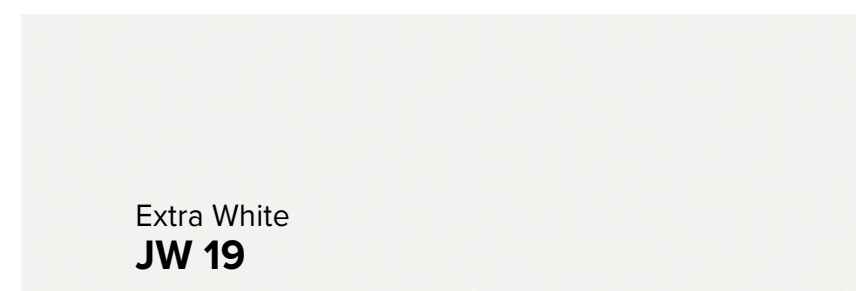

Extra White
JW 19



WALL: Raymi **JW 16** 1200x2400 / 48"x96" LUC RECT
FLOOR: Raymi **JW 16** 600x1197 / 24"x48" LUC RECT
WASHBASIN: BATHMOOD Happiness **JW 11** LUC + BATHMOOD Appeal **JW 16** LUC

COLORI

Colours | Farben | Couleurs | Colores | Цветов | 种颜色

BIANCO STATUARIO **JW 01**



Formati Nominali Nominal Sizes		Superficie Finish	Spessore mm Thickness mm
150x600 / 6"x24"	LUC RECT	9	
600x600 / 24"x24"	LUC RECT	9	
600x1197 / 24"x48"	LUC RECT	9	
1200x1200 / 48"x48"	LUC RECT	9	
1200x2400 / 48"x96"	LUC RECT	9	
1200x2780 / 48"x110"	LUC RECT	6	

Stucchi consigliati Recommended grouts		
KERAKOLL	02	
MAPEI	111 Grigio Argento	
LATICRETE	88 Silver Shadow	



EMPERADOR SELECTED **JW 05**



Formati Nominali Nominal Sizes		Superficie Finish	Spessore mm Thickness mm
150x600 / 6"x24"	LUC RECT	9	
600x600 / 24"x24"	LUC RECT	9	

Stucchi consigliati Recommended grouts		
KERAKOLL	47	
MAPEI	114 Antracite	
LATICRETE	45 Raven	



CALACATTA REALE **JW 02**



Formati Nominali Nominal Sizes		Superficie Finish	Spessore mm Thickness mm
150x600 / 6"x24"	LUC RECT	9	
600x600 / 24"x24"	LUC RECT	9	
600x1197 / 24"x48"	LUC RECT	9	
1200x1200 / 48"x48"	LUC RECT	9	
1200x2400 / 48"x96"	LUC RECT	9	
1200x2780 / 48"x110"	LUC RECT	6	
1600x1600 / 63"x63"	LUC RECT	9	
1600x3200 / 63"x126"	LUC RECT	6	

Stucchi consigliati Recommended grouts		
KERAKOLL	02	
MAPEI	111 Grigio Argento	
LATICRETE	88 Silver Shadow	



BLACK GOLD **JW 11**



Formati Nominali Nominal Sizes		Superficie Finish	Spessore mm Thickness mm
150x600 / 6"x24"	LUC RECT	9	
600x600 / 24"x24"	LUC RECT	9	
1200x2780 / 48"x110"	LUC RECT	6	

Stucchi consigliati Recommended grouts		
KERAKOLL	11	
MAPEI	114 Antracite	
LATICRETE	45 Raven	



ROYAL **JW 03**



Formati Nominali Nominal Sizes		Superficie Finish	Spessore mm Thickness mm
150x600 / 6"x24"	LUC RECT	9	
600x600 / 24"x24"	LUC RECT	9	
600x1197 / 24"x48"	LUC RECT	9	
1200x1200 / 48"x48"	LUC RECT	9	
1200x2400 / 48"x96"	LUC RECT	9	
1200x2780 / 48"x110"	LUC RECT	6	
1620x3240 / 63 3/4"x127 1/2"	SLK NOT RECT	12	

Stucchi consigliati Recommended grouts		
KERAKOLL	21	
MAPEI	110 Manhattan	
LATICRETE	89 Smoke Grey	



STATUARIO LUNENSIS **JW 12**



Formati Nominali Nominal Sizes		Superficie Finish	Spessore mm Thickness mm
150x600 / 6"x24"	LUC RECT	9	
600x600 / 24"x24"	LUC RECT	9	
600x1197 / 24"x48"	LUC RECT	9	
1200x1200 / 48"x48"	LUC RECT	9	
1200x2400 / 48"x96"	LUC RECT	9	
1200x2780 / 48"x110"	LUC RECT	6	
1620x3240 / 63 3/4"x127 1/2"	SLK NOT RECT	12	

Stucchi consigliati Recommended grouts		
KERAKOLL	02	
MAPEI	111 Grigio Argento	
LATICRETE	88 Silver Shadow	



COLORI

Colours | Farben | Couleurs | Colores | Цветов | 种颜色

STATUARIO VENATO **JW 14**



LEED Compliant **V2**

Formati Nominali Nominal Sizes	Superficie Finish	Spessore mm Thickness mm
150x600 / 6"x24"	NAT / LUC RECT	9
600x600 / 24"x24"	NAT / LUC RECT	9
600x1197 / 24"x48"	NAT / LUC RECT	9
1200x1200 / 48"x48"	LUC RECT	9
1200x2400 / 48"x96"	LUC RECT	9
1200x2780 / 48"x110"	NAT / LUC RECT	6
1600x1600 / 63"x63"	LUC RECT	6
1600x3200 / 63"x126"	LUC RECT	6
1620x3240 / 63 3/4"x127 1/2"	SLK / LUC NOT RECT	12

Stucchi consigliati Recommended grouts		
KERAKOLL	02	
MAPEI	111 Grigio Argento	
LATICRETE	88 Silver Shadow	

ONYKS **JW 15**



LEED Compliant **V2**

Formati Nominali Nominal Sizes	Superficie Finish	Spessore mm Thickness mm
150x600 / 6"x24"	NAT / LUC RECT	9
600x600 / 24"x24"	NAT / LUC RECT	9
600x1197 / 24"x48"	NAT / LUC RECT	9
1200x1200 / 48"x48"	LUC RECT	9
1200x2400 / 48"x96"	LUC RECT	9
1200x2780 / 48"x110"	LUC RECT	6
1600x1600 / 63"x63"	LUC RECT	6
1600x3200 / 63"x126"	LUC RECT	6

Stucchi consigliati Recommended grouts		
KERAKOLL	21	
MAPEI	110 Manhattan	
LATICRETE	89 Smoke Grey	

RAYMI **JW 16**



LEED Compliant **V2**

Formati Nominali Nominal Sizes	Superficie Finish	Spessore mm Thickness mm
150x600 / 6"x24"	NAT / LUC RECT	9
600x600 / 24"x24"	NAT / LUC RECT	9
600x1197 / 24"x48"	NAT / LUC RECT	9
1200x1200 / 48"x48"	NAT / LUC RECT	9
1200x2400 / 48"x96"	LUC RECT	9
1200x2780 / 48"x110"	NAT / LUC RECT	6
1600x1600 / 63"x63"	LUC RECT	6
1600x3200 / 63"x126"	LUC RECT	6

Stucchi consigliati Recommended grouts		
KERAKOLL	08	
MAPEI	112 Grigio Medio	
LATICRETE	78 Sterling Silver	

MOONLESS **JW 17**



LEED Compliant **V2**

Formati Nominali Nominal Sizes	Superficie Finish	Spessore mm Thickness mm
150x600 / 6"x24"	LUC RECT	9
600x600 / 24"x24"	LUC RECT	9
600x1197 / 24"x48"	LUC RECT	9
1200x2780 / 48"x110"	LUC RECT	6
1600x1600 / 63"x63"	LUC RECT	6
1600x3200 / 63"x126"	LUC RECT	6

Stucchi consigliati Recommended grouts		
KERAKOLL	12	
MAPEI	114 Antracite	
LATICRETE	45 Raven	

EXTRA WHITE **JW 19**

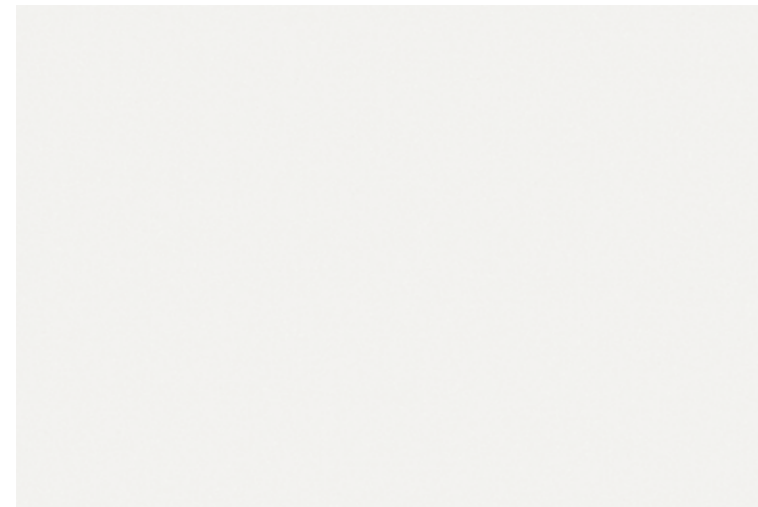

LEED Compliant **V2**

Formati Nominali Nominal Sizes	Superficie Finish	Spessore mm Thickness mm
150x600 / 6"x24"	NAT / LUC RECT	9
600x600 / 24"x24"	NAT / LUC RECT	9
600x1197 / 24"x48"	NAT / LUC RECT	9
1200x1200 / 48"x48"	NAT / LUC RECT	9
1200x2400 / 48"x96"	LUC RECT	9
1200x2780 / 48"x110"	NAT / LUC RECT	6
1600x1600 / 63"x63"	LUC RECT	6
1600x3200 / 63"x126"	LUC RECT	6

Stucchi consigliati Recommended grouts		
KERAKOLL	02	
MAPEI	111 Grigio Argento	
LATICRETE	88 Silver Shadow	

RIASSUNTIVO FORMATI ED IMBALLI

Summary of sizes and packaging | Übersicht über Formate und Verpackungen | Récapitulatif formats et emballages
Sinóptico de formatos y embalajes | Краткая информация о форматах и упаковках | 规格和包装概述

											± 9 mm
Formati Nominali Nominal Sizes		150x600 6"x24"	600x600 24"x24"	600x1197 24"x48"	1200x1200 48"x48"	1200x2400 48"x96"					
Tutti i formati sono rettificati. All sizes are rectified.											
Superficie Finish		NAT	LUC	NAT	LUC	NAT	LUC	NAT	LUC	LUC	
	BIANCO STATUARIO JW 01	V2	-	■	-	■	-	■	-	■	■
	CALACATTA REALE JW 02	V2	-	■	-	■	-	■	-	■	■
	ROYAL JW 03	V2	-	■	-	■	-	■	-	■	■
	EMPERADOR SELECTED JW 05	V2	-	■	-	■	-	■	-	■	■
	BLACK GOLD JW 11	V2	-	■	-	■	-	■	-	■	■
	STATUARIO LUNENSIS JW 12	V2	-	■	-	■	-	■	-	■	■
	STATUARIO VENATO JW 14	V2	■	■	■	■	■	■	-	■	■
	ONYKS JW 15	V2	■	■	■	■	■	■	-	■	■
	RAYMI JW 16	V2	■	■	■	■	■	■	■	■	■
	MOONLESS JW 17	V2	-	■	-	■	-	■	-	■	■
	EXTRA WHITE JW 19	V2	■	■	■	■	■	■	■	■	■
	Peso lordo per scatola Gross weight per box	26,92	25,26	22,16	22,02	29,60	29,14	61,56	61,56	Please refer to page 588	
	Pezzi per scatola Pieces for box	14	14	3	3	2	2	2	2		
	mq. scatola sqm. box	1,26	1,26	1,08	1,08	1,436	1,436	2,88	2,88		
	Scatole / Full pallet boxes / Full pallet	40	40	40	40	35	35	20	20		
	mq. pallet sqm. pallet	50,40	50,40	43,20	43,20	50,26	50,26	57,60	57,60		

											± 6 mm	± 12 mm
Formati Nominali Nominal Sizes		1200x2780 48"x110"	* Kit Vein Matching 1200x2780 48"x110"	1600x1600 63"x63"	1600x3200 63"x126"	1620x3240 63¾"x127½"						
Tutti i formati sono rettificati, eccetto il formato 1620x3240. All sizes except 1620x3240 are rectified.												
Superficie Finish		LUC	NAT	LUC	LUC	LUC	SLK	LUC				
	BIANCO STATUARIO JW 01	V2	■	-	-	-	-	-	-	-		
	CALACATTA REALE JW 02	V2	■	-	-	■	-	-	-	-		
	ROYAL JW 03	V2	■	-	-	-	■	-	-	-		
	EMPERADOR SELECTED JW 05	V2	-	-	-	-	-	-	-	-		
	BLACK GOLD JW 11	V2	■	-	-	-	-	-	-	-		
	STATUARIO LUNENSIS JW 12	V2	■	-	-	-	■	-	-	-		
	STATUARIO VENATO JW 14	V2	■	■	■	■	■	■	■	■		
	ONYKS JW 15	V2	■	-	-	■	-	-	-	-		
	RAYMI JW 16	V2	■	■	-	■	-	-	-	-		
	MOONLESS JW 17	V2	■	-	-	■	-	-	-	-		
	EXTRA WHITE JW 19	V2	■	■	-	■	-	-	-	-		
	Peso lordo per scatola Gross weight per box	Please refer to page 588		Please refer to page 588		Please refer to page 588		Please refer to page 588		Please refer to page 588		
	Pezzi per scatola Pieces for box	Please refer to page 588		Please refer to page 588		Please refer to page 588		Please refer to page 588		Please refer to page 588		
	mq. scatola sqm. box	Please refer to page 588		Please refer to page 588		Please refer to page 588		Please refer to page 588		Please refer to page 588		
	Scatole / Full pallet boxes / Full pallet	Please refer to page 588		Please refer to page 588		Please refer to page 588		Please refer to page 588		Please refer to page 588		
	mq. pallet sqm. pallet	Please refer to page 588		Please refer to page 588		Please refer to page 588		Please refer to page 588		Please refer to page 588		

* Kit Vein Matching (5 pz / 5 pcs)

Per tutti i grandi formati è possibile prevedere, su richiesta, e con un lotto minimo l'applicazione di una stuoia in fibra di vetro.
For big sizes, a fibreglass mat can be applied on request, with a minimum production batch.

Per garantire elevati standard di sicurezza e le migliori performance tecniche in relazione al loro utilizzo finale (piani cucina, top, arredi), tutte le lastre in formato 1620x3240 in spessore 12mm prevedono l'applicazione di una stuoia in fibra di vetro sul retro della lastra.
All the 1620x3240 slabs in 12mm thickness are provided with a fibreglass mat applied to the back of the slab, to guarantee substantial safety standards and suitable technical performance required for their final use (kitchen countertops, tops, furnishings).

MY NOTES

.....

.....

.....

.....

.....

Maggiori informazioni
More information



ACCORGIMENTI SPECIFICI PER L'APPLICAZIONE DELLE GRANDI LASTRE IN 6 MM DI SPESSORE: p. 582 | Precautions for 6mm big slabs applications: page 582 | spezifische Anweisungen zur Nutzung der Grossformate in 6mm: seite 582 | Precauciones específicas para la aplicación de las grandes placas en 6 mm de espesor: page 582 | Precautions spécifiques pour la pose des grandes plaques en 6mm d'épaisseur: página 582 | специальные предосторожности для укладки больших плит толщиной 6 мм : страница 582

RACCOMANDAZIONI PER UTILIZZO E CURA DELLE LASTRE COUNTERTOPS p. 583 | How to use and take good care of the COUNTERTOPS slabs p. 583 | Tipps für den Einsatz und die Pflege der Platten COUNTERTOPS p. 583 | Recomendaciones para el uso y cuidado de las placas COUNTERTOPS p. 583 | Рекомендации по использованию и уходу за плитami COUNTERTOPS p.583 | 规格的COUNTERTOPS系列陶瓷板的使用和护理建议 583

NAT: Naturale | Natural | Natur-unpoliert | Naturelle | Natural | Натуральный | 天然
LUC: Lucido | Glossy | Lucida | Lucida | Lustrado | блестящая | 闪亮
SLK: Silk

PEZZI SPECIALI

Special pieces | Sonderstücke | Pièces spéciales | Piezas especiales | специальные изделия | 特殊件

Pezzi speciali Special pieces	Battiscopa*		Gradino A*		Gradino G*
	72x600 27/8"x24"		300x600 12"x24"		300x600 12"x24"
Superficie Finish	NAT	LUC	NAT	LUC	NAT
BIANCO STATUARIO JW 01	-	■	-	■	-
CALACATTA REALE JW 02	-	■	-	■	-
ROYAL JW 03	-	■	-	■	-
EMPERADOR SELECTED JW 05	-	■	-	■	-
BLACK GOLD JW 11	-	■	-	■	-
STATUARIO LUNENSIS JW 12	-	■	-	■	-
STATUARIO VENATO JW 14	■	■	■	■	■
ONYKS JW 15	■	■	■	■	■
RAYMI JW 16	■	■	■	■	■
MOONLESS JW 17	-	■	-	■	-
EXTRA WHITE JW 19	■	■	■	■	■
Pezzi per scatola Pieces for box	10	10	7	7	7

* Finitura a becco di civetta | One-round edge shaping | Ausführung mit Eckabrundung | Façonnage à bord rond | Acabado canto romo | Плитка с завалом | 鹰嘴边缘处理

Pezzi speciali Special pieces	Gradino B ang.		Gradino B		Gradino B
	330x330 13/8"x13/8"		330x600 13/8"x24"		330x1197 13/8"x48"
Superficie Finish	NAT	LUC	NAT	LUC	LUC
BIANCO STATUARIO JW 01	-	■	-	■	■
CALACATTA REALE JW 02	-	■	-	■	■
ROYAL JW 03	-	■	-	■	■
EMPERADOR SELECTED JW 05	-	■	-	■	-
BLACK GOLD JW 11	-	■	-	■	-
STATUARIO LUNENSIS JW 12	-	■	-	■	■
STATUARIO VENATO JW 14	■	■	■	■	■
ONYKS JW 15	■	■	■	■	■
RAYMI JW 16	■	■	■	■	■
MOONLESS JW 17	-	■	-	■	■
EXTRA WHITE JW 19	■	■	■	■	■
Pezzi per scatola Pieces for box	4	4	4	4	2

DECORI

Decors | Dekore | Decors | Decoros | Декоры | 装饰砖

Mosaico 144 LUC
300x300 / 12"x12"
Tessere 22x22 / 4/5"x4/5"

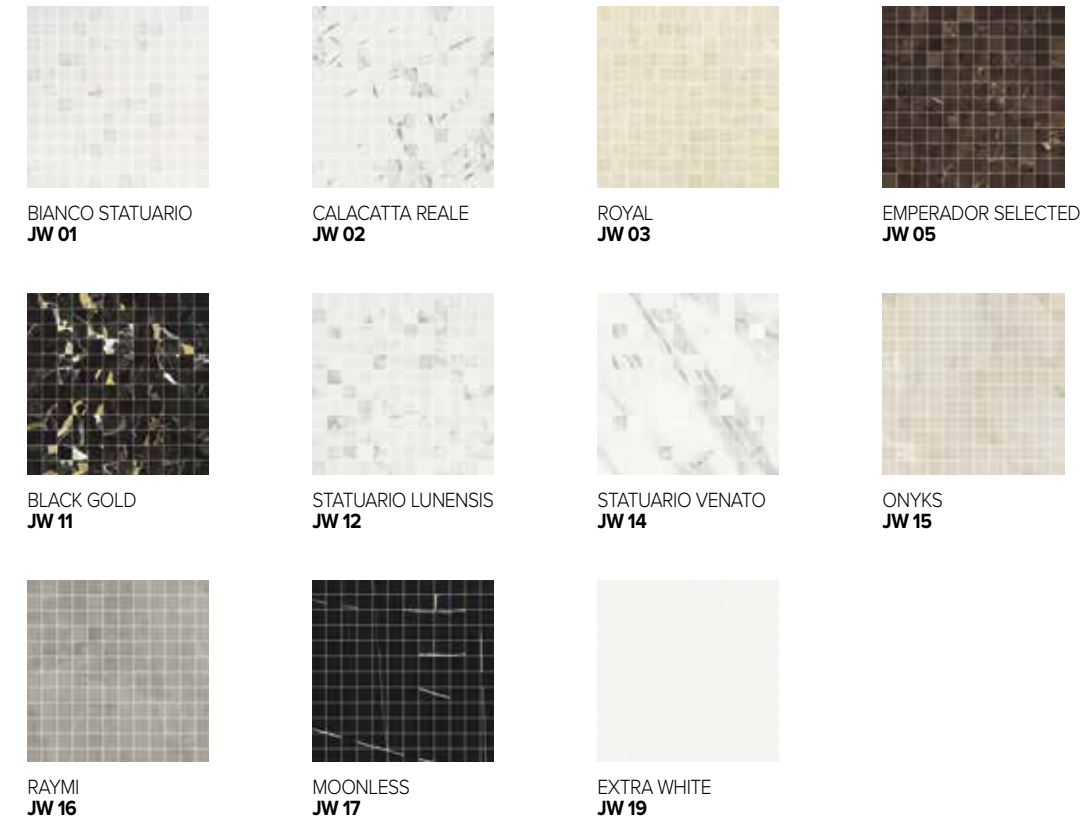

Mosaico 36T NAT
300x300 / 12"x12"
Tessere 48x48 / 2"x2"

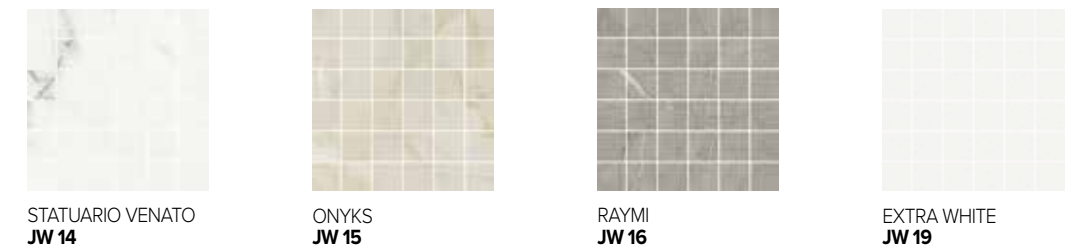

Pezzi per scatola
Pieces for box

Mosaico 144T 6

Mosaico 36T 6

COMPOSIZIONI

Compositions | Kombinationen | Compositions | Composiciones | Композиции | 组合

FRAME

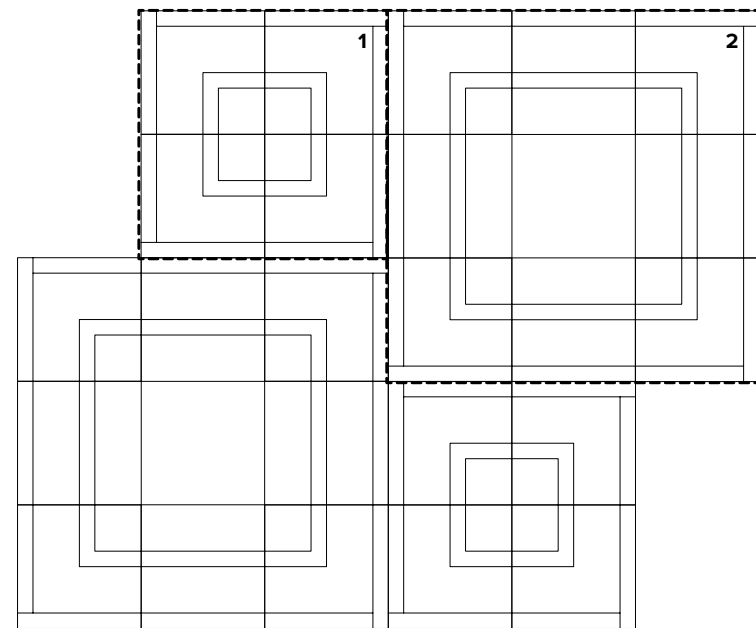
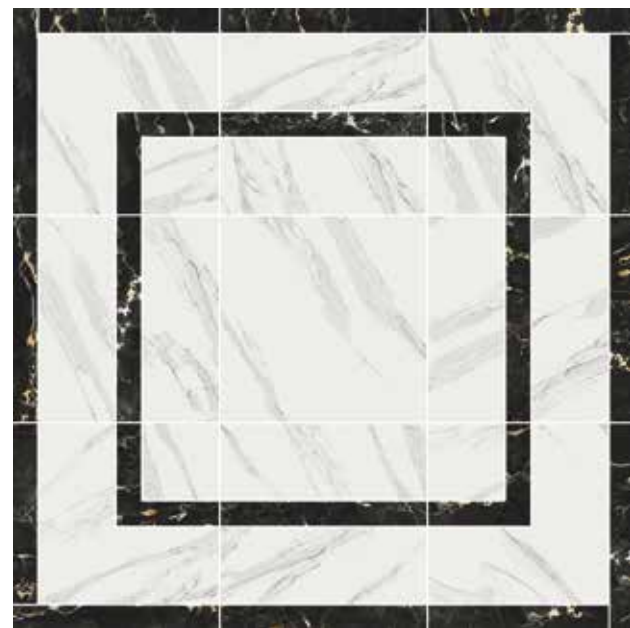

Abbinamento consigliato | Suggested match

- CALACATTA REALE **JW 02**
- BLACK GOLD **JW 11**

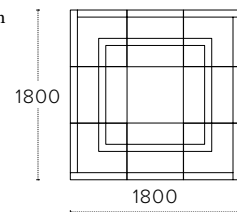

MATRIX



Inserti disponibili
Available insert

- Satin Insert**
- Silver Insert**
- Gold Insert**

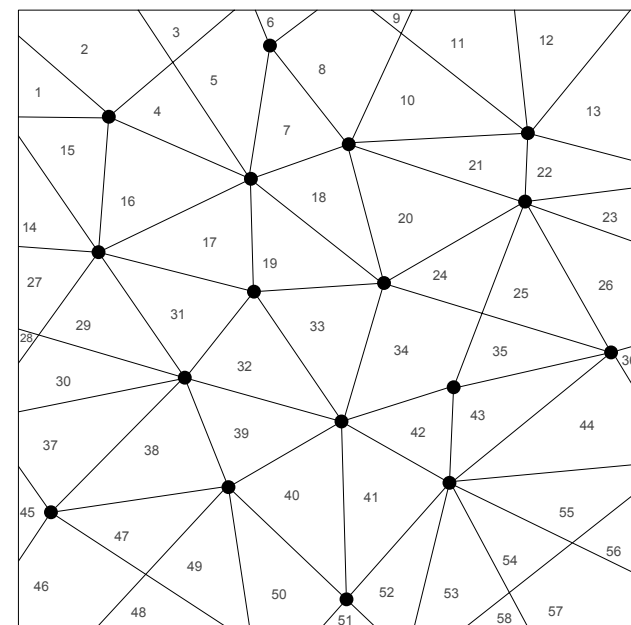

Abbinamento consigliato | Suggested match

- CALACATTA REALE **JW 02**

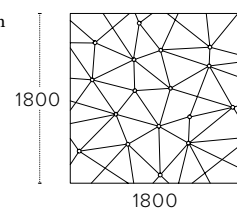

GEOMETRIC



Abbinamento consigliato | Suggested match

- RAYMI **JW 16**
- STATUARIO VENATO **JW 14**
- BLACK GOLD **JW 11**

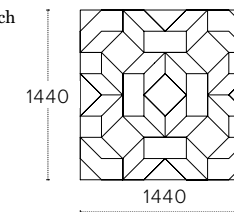

Tutte le composizioni Jewels Suit vengono consegnate imballate sequenzialmente, per agevolare le operazioni di posa del materiale. Ogni singolo pezzo viene numerato ed avrà una corrispondenza su una tavola di progetto consegnata assieme al materiale.

[EN] All Jewels Suit compositions are delivered packaged in sequence, to facilitate laying operations. Each piece is numbered and shown on the design layout supplied with the material.

[DE] Alle Jewels Suit-Kombinationen werden in der richtigen Reihenfolge verpackt geliefert, um das Verlegen des Materials zu erleichtern. Jedes einzelne Stück wird nummeriert und ist auf einem Projekt dargestellt, das zusammen mit dem Material geliefert wird.

[FR] Toutes les compositions Jewels Suit seront livrées emballées dans un ordre séquentiel, pour faciliter la réalisation du calepinage. Chaque pièce est numérotée et sa place sera indiquée sur une planche de projet remise avec le matériau.

[ES] Todas las composiciones Jewels Suit se entregan en un embalaje secuencial para agilizar las operaciones de colocación del material. Se enumera cada pieza junto con su respectivo equivalente en una tabla de proyecto, que también se entregará con el material.

[RU] Все композиции Jewels Suit поставляются упакованными в определенной последовательности для упрощения операции укладки. Каждый отдельный элемент нумеруется, и соответствующий номер указывается на проектной чертеже, поставляемом вместе с материалом.

[中文] 所有 Jewels Suit 组合均按顺序包装, 方便材料的铺贴操作。每一块瓷砖均有编号, 并在与材料一起交付的项目表上有对应编号。



Kit speciali per posa a macchia aperta.

JW 14 è disponibile anche in speciali kit che permettono di realizzare la posa **“BOOK MATCHING”** o **“DIAMOND MATCHING”**.

Le composizioni possono essere abbinata al fondo, di cui mantengono formato e calibro. Per un risultato ancora più ricercato e prezioso.

JW 14 is also available in special kits that can be used for the **“Book Matching”** or **“Diamond Matching”** laying schemes.

The compositions can be combined with the base tiles, which have the same size and worksize, for an even more beautiful, sophisticated effect.



JW 12 - 1200x2780 / 48"x110" LUC

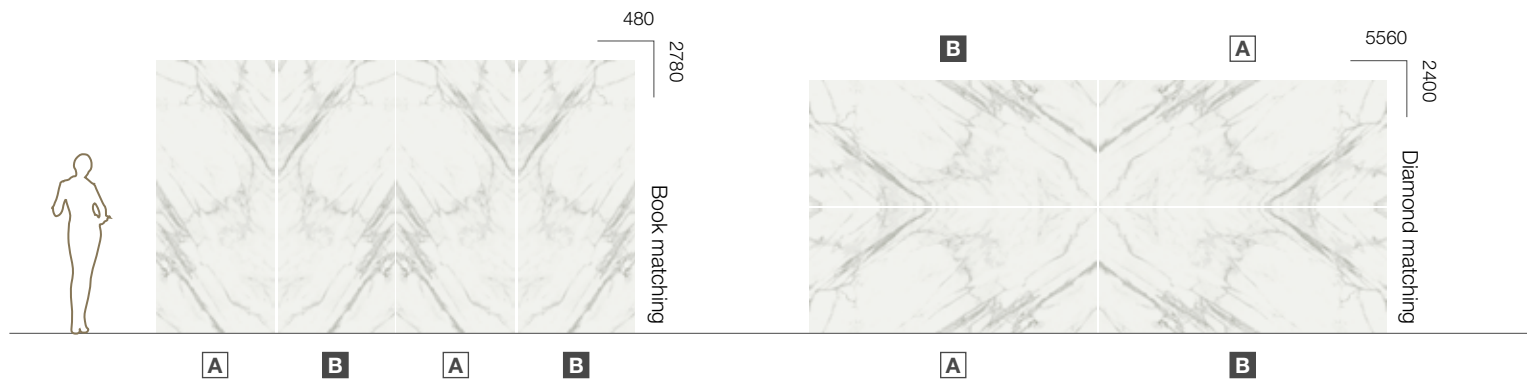

JW 14 existent aussi en kits spéciaux qui permettent de réaliser la pose « **Book Matching** » ou « **Diamond Matching** ».

JW 14 sind auch in speziellen Sets erhältlich, die die Verlegung **“Book Matching”** oder **“Diamond Matching”** ermöglichen.

JW 14 también están disponibles en kits especiales que permiten realizar la colocación **“Book Matching”** o **“Diamond Matching”**.

Изделия JW 14 представлены также в специальных комплектах для укладки по схеме **“открытая книга” (Book Matching)** или **“ромб” (Diamond Matching)**.

JW14还备有特殊套件，可以实现**“书页式对拼”**或**“钻石对拼”**铺设。组合可以与底砖匹配，保持其尺寸和口径，旨在追求更加考究和精美的效果。

Il processo produttivo non garantisce la continuità nel disegno della venatura tra i vari pezzi spediti. Eventuali disallineamenti tra le venature in continuità sono da considerarsi caratteristica intrinseca del prodotto.

The production process does not guarantee continuity in the design of the veining among the various pieces provided. Any misalignment between the continuous veining is to be considered an intrinsic characteristic of the product.

Kit Vein Matching.

Per offrire un servizio sempre più personalizzato, Mirage® mette a disposizione il Kit Vein Matching nei colori Statuario Lunensis JW 12 e Statuario Venato JW 14 in formato 1200x2780 mm, superficie lucida. Il kit è composto da 5 lastre numerate e dalle grafiche sequenziali ad effetto vena continua.

For an increasingly customised service, Mirage® offers the Vein Matching Kit in JW 12 and JW 14 colours, in the 1200x2780 mm size, glossy finish. The kit is composed of 5 numbered slabs and sequential patterns that create a continuous vein effect.



JW 12 - 1200x2780 / 48"x110" LUC



JW 14 - 1200x2780 / 48"x110" LUC

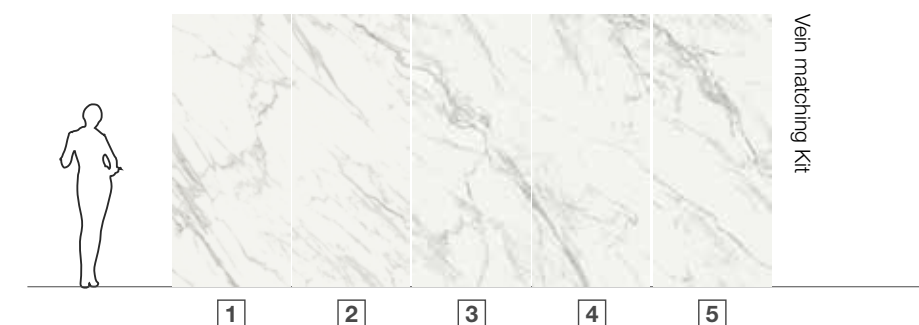

Il processo produttivo non garantisce la continuità nel disegno della venatura tra i vari pezzi spediti. Eventuali disallineamenti tra le venature in continuità sono da considerarsi caratteristica intrinseca del prodotto.

The production process does not guarantee continuity in the design of the veining among the various pieces provided. Any misalignment between the continuous veining is to be considered an intrinsic characteristic of the product.

CARATTERISTICHE TECNICHE

Technical specifications | Technische Eigenschaften | Caractéristiques techniques | Características técnicas | Технические характеристики | 技术特征



FLOOR: Calacatta Reale **JW 02** 600x1200 / 24"x48" LUC RECT
 WALL: Calacatta Reale **JW 02** 1200x2780 / 48"x110" LUC RECT
 COUNTER: Cosmopolitan Amazonzite **CP 07** LUC

STANDARD EN 14411 - G

	CARATTERISTICHE TECNICHE TECHNICAL DATA TECHNISCHE DATEN CARACTERISTIQUES TECHNIQUES CARACTERÍSTICAS TÉCNICAS ТЕХНИЧЕСКИЕ ХАРАКТЕРИСТИКИ 技术特征	NORMA STANDARD NORM NORME NORMA ЗНАЧЕНИЯ 标准	VALORI PRESCRITTI DALLE NORME EN 14411 - G INTERNATIONAL STANDARDS EN 14411 - G INTERNATIONALE NORMWERTE EN 14411 - G VALEURS PREVUES PAR LES NORMES EN 14411 - G VALORES PREVISTOS POR LAS NORMAS EN 14411 - G ПРЕДУСМОТРЕННЫЕ СТАНДАРТОМ EN 14411-G EN 14411 - G标准规定值	VALORE MEDIO MIRAGE MIRAGE AVERAGE VALUE MIRAGE MITTELWERT VALEUR MOYEN MIRAGE VALOR MEDIO MIRAGE СРЕДНЕЕ ЗНАЧЕНИЕ MIRAGE MIRAGE平均值		
				NAT (UGL)	LUC (GL)	SLK (UGL)
	CARATTERISTICHE DIMENSIONALI - SIZE CHARACTERISTICS - MASSEIGENSCHAFTEN DETERMINATION DES CARACTERISTIQUES DIMENSIONNELLES - CARACTERÍSTICAS DIMENSIONALES - РАЗМЕРНЫЕ ХАРАКТЕРИСТИКИ - 尺寸特征					
	LATI SIDES - SEITEN COTES - CANTOS РАЗМЕРЫ СТОРОН - 侧边	EN ISO 10545-2	± 0,3% MAX (± 1,0 mm MAX)	CONFORME COMPLYING		
	SPESORE THICKNESS - DICKE ÉPAISSEUR - ESPESOR ТОЛЩИНА - 厚度	EN ISO 10545-2	± 5,0% MAX (± 0,5 mm MAX)	CONFORME COMPLYING		
	RETTILINEITÀ DEGLI SPIGOLI STRAIGHTNESS OF SIDES - GERADLINIGKEIT DER KANTEN RECTITUDE DES ARES - RECTITUD DE LOS CANTOS КОСОУГОЛЬНОСТЬ - 边角平直度	EN ISO 10545-2	± 0,3% MAX (± 0,8 mm MAX)	CONFORME COMPLYING		
	ORTOGONALITÀ RECTANGULARITY - RECHTWINKLIGKEIT PERPENDICULARITÉ - ORTOGONALIDAD КРИВИЗНА СТОРОН - 直角度	EN ISO 10545-2	± 0,3% MAX (± 1,5 mm MAX)	CONFORME COMPLYING		
	PLANARITÀ SURFACE FLATNESS - EBENFLÄCHIGKEIT PLANEITE DE SURFACE - PLANEIDAD КРИВИЗНА ЛИЦЕВОЙ ПОВЕРХНОСТИ - 平整度	EN ISO 10545-2	± 0,4% MAX (± 1,8 mm MAX)	CONFORME COMPLYING		
	ASSORBIMENTO D'ACQUA WATER ABSORPTION - WASSERAUFNAHME ABSORPTION D'EAU - ABSORCIÓN DE AGUA ВОДОПОГЛОЩЕНИЕ - 吸水率	EN ISO 10545-3	≤ 0,5%	≤ 0,1%	≤ 0,1%	≤ 0,1%
	RESISTENZA ALLA FLESSIONE FLEXION RESISTANCE - BIEGEFESTIGKEIT RESISTANCE A LA FLEXION - RESISTENCIA A LA FLEXIÓN ПРЕДЕЛ ПРОЧНОСТИ ПРИ ИЗГИБЕ - 抗弯强度	EN ISO 10545-4	S ≥ 700 N (< 7,5 mm) S ≥ 1.300 N (> 7,5 mm) R ≥ 35 N/mm²	≠ 6 mm: S ≥ 1100 N R ≥ 45 N/mm² ≠ 9 mm: S ≥ 2.500 N R ≥ 48 N/mm² ≠ 12 mm: S ≥ 4.500 N R ≥ 48 N/mm²		
	RESISTENZA ALL'URTO IMPACT RESISTANCE - STOSSFESTIGKEIT RESISTANCE AUX CHOCS - RESISTENCIA A LOS GOLPES УДАРСТОЙКОСТЬ - 抗冲击强度	EN ISO 10545-5	VALORE DICHIARATO DECLARED VALUE	> 0,89	> 0,89	> 0,89
	RESISTENZA ALL'ABRASIONE ABRASION RESISTANCE - ABRIEBFESTIGKEIT RESISTANCE A L'ABRASION - RESISTENCIA A LA ABRASIÓN СТОЙКОСТЬ К ИСТИРАНИЮ - 耐磨强度	EN ISO 10545-6	≤ 175 mm³	< 175 mm³	< 150 mm³	< 150 mm³
	COEFFICIENTE DI DILATAZIONE TERMICA LINEARE COEFFICIENT OF LINEAR THERMAL EXPANSION - LINEARER WÄRMEAUSSDEHNUNGSKOEFFIZIENT - COEFFICIENT DE DILATATION THERMIQUE LINEAIRE - COEFICIENTE DE DILATACIÓN TÉRMICA LINEAL - КОЭФФИЦИЕНТ ЛИНЕЙНОГО ТЕРМИЧЕСКОГО РАСШИРЕНИЯ - 线性热膨胀系数	EN ISO 10545-8	-	α 6,2x10 ⁻⁶ °C ⁻¹	α 6,2x10 ⁻⁶ °C ⁻¹	α 6,2x10 ⁻⁶ °C ⁻¹
	RESISTENZA AGLI SBALZI TERMICI RESISTANCE TO THERMAL SHOCKS - BESTÄNDIGKEIT GEGEN TEMPERATURSCHWANKUN- GEN - RESISTANCE AUX CHOCS THERMIQUES - RESISTENCIA A LOS CHOQUES TÉRMICOS - СТОЙКОСТЬ К ПЕРЕПАДАМ ТЕМПЕРАТУРЫ - 耐热突变性	EN ISO 10545-9	TEST SUPERATO SECONDO EN ISO 10545-1 PASS ACCORDING EN ISO 10545-1	NESSUN DANNO NO DAMAGE		
	RESISTENZA AL GELO FROST RESISTANCE - FROSTBESTÄNDIGKEIT RESISTANCE AU GEL - RESISTENCIA AL HIELO МОРОЗОСТОЙКОСТЬ - 耐冻性	EN ISO 10545-12	TEST SUPERATO SECONDO EN ISO 10545-1 PASS ACCORDING EN ISO 10545-1	NESSUN DANNO NO DAMAGE		
	RESISTENZA ALL'ATTACCO CHIMICO RESISTANCE TO CHEMICALS - CHEMIKALIENBESTÄNDIGKEIT RESISTANCE A L'ATTAQUE CHIMIQUE - RESISTENCIA QUÍMICA ХИМИЧЕСКАЯ СТОЙКОСТЬ - 耐化学品作用	EN ISO 10545-13	B MIN.	A LA HA	A LA	A LA HA
	RESISTENZA ALL'ABRASIONE SUPERFICIALE SURFACE ABRASION RESISTANCE - ABRIEBFESTIGKEIT DER OBERFLÄCHE RÉSISTANCE À L'ABRASION SUPERFICIELLE - RESISTENCIA A LA ABRASIÓN SUPERFICIAL - ХИМИЧЕСКАЯ СТОЙКОСТЬ - 耐表面磨损	EN ISO 10545-7	-	LUC PEI 5 (JW 01-02-03-12-14-15-19) PEI 4 (JW 16) / PEI 3 (JW 05) / PEI 2 (JW 11-17) *		
	RESISTENZA ALLE MACCHIE RESISTANCE TO STAINS - FLECKENBESTÄNDIGKEIT RESISTANCE AUX TACHES - RESISTENCIA A LAS MANCHAS УСТОЙЧИВОСТЬ К ПЯТНООБРАЗОВАНИЮ - 防污性	EN ISO 10545-14	VALORE DICHIARATO DECLARED VALUE	5	5	5
				NAT	LUC	SLK
		DM 236/89 BCRA	> 0,40	> 0,40	-	-
		ANSI A326.3	Wet and Dry	≥ 0,42	-	-
		AS 4586	-	P2	-	-
		DIN 51130	-	R9	-	-
		DIN 51097	-	-	-	-
		UNE 41901	≥ CL1	CL1	-	-
		BS 7976 sl.96-4S	Wet and Dry	-	-	-
		BS 7976 sl.55-TRL	Wet and Dry	-	-	-
	SCIVOLOSITÀ SKID RESISTANCE - RUTSCHWERT GLISSANCE - ADHERENCIA СКОЛЬЗКОСТЬ - 防滑性					

Per i certificati specifici, contattare Mirage Spa - For specific certificates, please contact Mirage Spa - Für die speziellen Zertifikate wenden Sie sich bitte an Mirage SpA - Pour les certificats spécifiques, veuillez contacter Mirage SPA - Para los certificados específicos, contactar Mirage SPA - Для сертификатов обращайтесь в компанию Mirage SpA - 关于具体的证书,请联系Mirage Spa公司

* La superficie LUC può essere soggetta a graffi se in contatto con materiali più duri (es sassi, frammenti di piastrella, etc...) LUC finish can be subjected to scratches if in contact with harder materials (eg stones, tile fragments, etc...)



FLOOR: Washington **JL 04** 1200x1200 / 48"x48" LUC RECT
WALL: Washington **JL 04** 1200x2780 / 48"x110" LUC RECT + NORR Grå **RR 02** 1200x2780 / 48"x110" NAT RECT

JOLIE

Jolie is an anthology of iconic marble effects in porcelain stoneware.

Rare and pure references, where every vein and every single slab are carefully selected to create a precious and timeless style. 7 colors that can be used for floors and walls, but also furnishings and finishes, to create and design any type of style and environment.



Calacatta Vena Antica **JL 03** 1200x1200 / 48"x48" LUC RECT

COLORI

Colours | Farben | Couleurs | Colores | Цветов | 种颜色

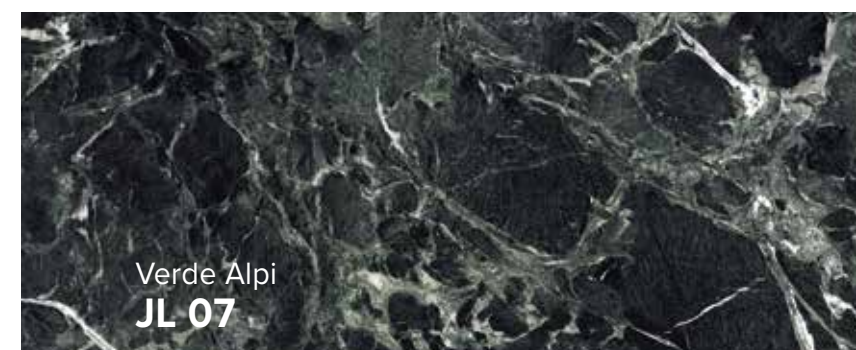
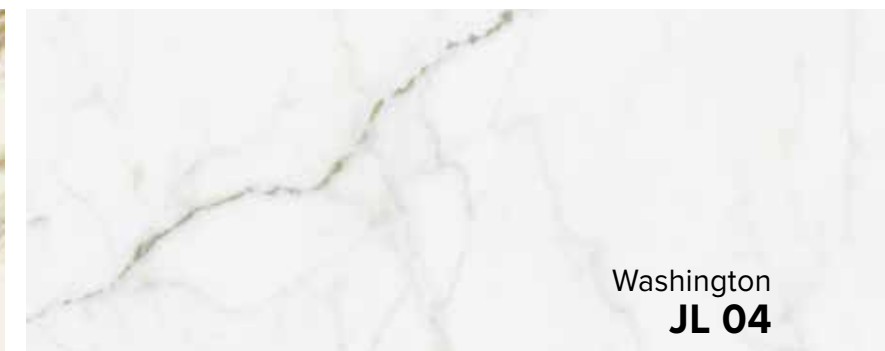

WALL AND COUNTER: Pietra Grey **JL 06** 1200x2780 / 48"x110" SP RECT
FLOOR: ELYSIAN Travertino Light **EY 07** 1200x1200 / 48"x48" SP RECT



WALL: Pietra Grey **JL 06** 1200x2780 / 48"x110" SP RECT + WANDERLUST Agata Multicolor **WA 09** 1200x2780 / 48"x110" LUC RECT
FLOOR: JURUPA Wild **JP 05** 200x1200 / 8"x48" NAT RECT
VANITY UNIT: BATHMOOD Glad **JL 06** SP + BATHMOOD Stay **WA 09** LUC + BATHMOOD Vertical Bliss Mirror **JL 06** SP



WALL: Statuario Fine **JL 01** 1200x2780 / 48"x110" LUC RECT Vein Matching
FLOOR: Statuario Fine **JL 01** 1200x1200 / 48"x48" LUC RECT
TABLE: WANDERLUST Galway Green **WA 12** LUC

COLORI

Colours | Farben | Couleurs | Colores | Цветов | 种颜色

STATUARIO FINE **JL 01**



Formati Nominali Nominal Sizes		Superficie Finish	Spessore mm Thickness mm
800x800 / 31½"x31½"	LUC / SP RECT	9	
800x1600 / 31½"x63"	LUC / SP RECT	9	
600x1200 / 48"x48"	LUC / SP RECT	9	
1200x1200 / 48"x48"	LUC / SP RECT	9	
600x1200 / 48"x48"	PRL RECT	6	
1200x2780 / 48"x110"	LUC / SP RECT	6	

Stucchi consigliati Recommended grouts		
KERAKOLL	02	
MAPEI	103 Bianco Luna	
LATICRETE	50 Sea Glass	



CALACATTA SELECT **JL 02**



Formati Nominali Nominal Sizes		Superficie Finish	Spessore mm Thickness mm
800x800 / 31½"x31½"	LUC / SP RECT	9	
800x1600 / 31½"x63"	LUC / SP RECT	9	
600x1200 / 48"x48"	LUC / SP RECT	9	
1200x1200 / 48"x48"	LUC / SP RECT	9	
600x1200 / 48"x48"	PRL RECT	6	
1200x2780 / 48"x110"	LUC / SP RECT	6	

Stucchi consigliati Recommended grouts		
KERAKOLL	02	
MAPEI	103 Bianco Luna	
LATICRETE	50 Sea Glass	



CALACATTA VENA ANTICA **JL 03**



Formati Nominali Nominal Sizes		Superficie Finish	Spessore mm Thickness mm
800x800 / 31½"x31½"	LUC RECT	9	
800x1600 / 31½"x63"	LUC RECT	9	
600x1200 / 48"x48"	LUC / SP RECT	9	
1200x1200 / 48"x48"	LUC RECT	9	
1200x2780 / 48"x110"	LUC RECT	6	
1620x3240 / 63¾"x127½"	SLK NOT RECT	12	

Stucchi consigliati Recommended grouts		
KERAKOLL	24	
MAPEI	103 Bianco Luna	
LATICRETE	50 Sea Glass	



WASHINGTON **JL 04**



Formati Nominali Nominal Sizes		Superficie Finish	Spessore mm Thickness mm
800x800 / 31½"x31½"	LUC / SP RECT	9	
800x1600 / 31½"x63"	LUC / SP RECT	9	
600x1200 / 48"x48"	LUC / SP RECT	9	
1200x1200 / 48"x48"	LUC / SP RECT	9	
600x1200 / 48"x48"	PRL RECT	6	
1200x2780 / 48"x110"	LUC / SP RECT	6	
Line 1200x2780 / 48"x110"	SP RECT	6	
1620x3240 / 63¾"x127½"	SLK NOT RECT	12	

Stucchi consigliati Recommended grouts		
KERAKOLL	02	
MAPEI	103 Bianco Luna	
LATICRETE	50 Sea Glass	



TUNDRA LITE **JL 05**



Formati Nominali Nominal Sizes		Superficie Finish	Spessore mm Thickness mm
800x800 / 31½"x31½"	LUC / SP RECT	9	
800x1600 / 31½"x63"	LUC / SP RECT	9	
600x1200 / 48"x48"	LUC / SP RECT	9	
1200x1200 / 48"x48"	LUC / SP RECT	9	
600x1200 / 48"x48"	PRL RECT	6	
1200x2780 / 48"x110"	LUC / SP RECT	6	

Stucchi consigliati Recommended grouts		
KERAKOLL	08	
MAPEI	113 Grigio Cemento	
LATICRETE	78 Sterling Silver	



PIETRA GREY **JL 06**



Formati Nominali Nominal Sizes		Superficie Finish	Spessore mm Thickness mm
800x800 / 31½"x31½"	LUC / SP RECT	9	
800x1600 / 31½"x63"	LUC / SP RECT	9	
600x1200 / 48"x48"	LUC / SP RECT	9	
1200x1200 / 48"x48"	LUC / SP RECT	9	
600x1200 / 48"x48"	PRL RECT	6	
1200x2780 / 48"x110"	LUC / SP RECT	6	
1620x3240 / 63¾"x127½"	SLK NOT RECT	12	

Stucchi consigliati Recommended grouts		
KERAKOLL	11	
MAPEI	114 Antracite	
LATICRETE	45 Raven	









COLORI

Colours | Farben | Couleurs | Colores | Цветов | 种颜色

VERDE ALPI **JL 07**



 Formati Nominali Nominal Sizes	 Superficie Finish	 Spessore mm Thickness mm
600x1200 / 48"x48"	LUC / SP RECT	9
1200x1200 / 48"x48"	LUC RECT	9
600x1200 / 48"x48"	PRL RECT	6
1200x2780 / 48"x110"	LUC RECT	6

 Stucchi consigliati Recommended grouts		
KERAKOLL	11	
MAPEI	114 Antracite	
LATICRETE	45 Raven	

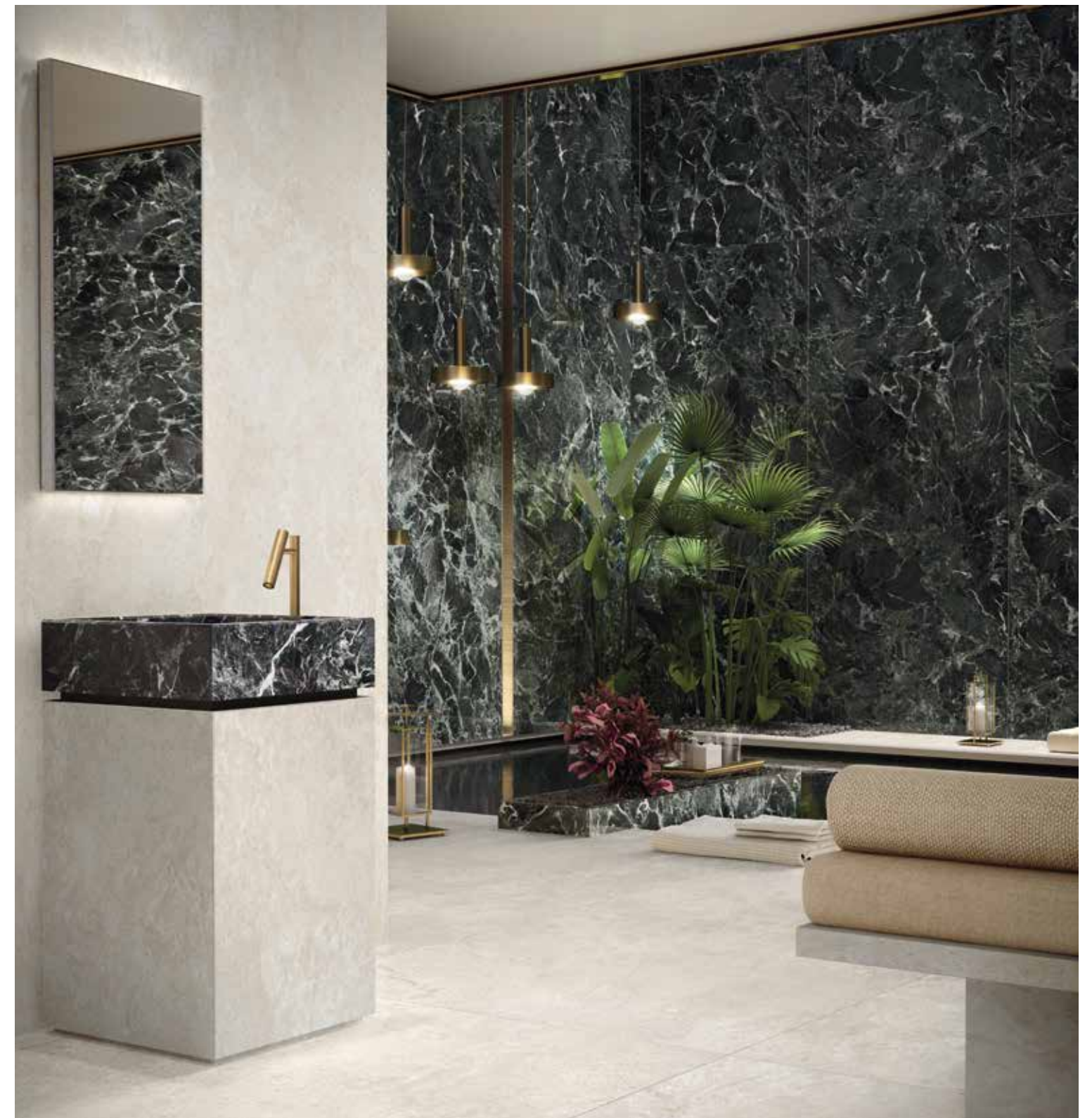

RIASSUNTIVO FORMATI ED IMBALLI

Summary of sizes and packaging | Übersicht über Formate und Verpackungen | Récapitulatif formats et emballages
Sinóptico de formatos y embalajes | Краткая информация о форматах и упаковках | 规格和包装概述

		± 9 mm							
Formati Nominali Nominal Sizes		800x800 31½"x31½"		800x1600 31½"x63"		600x1200 24"x48"		1200x1200 48"x48"	
Tutti i formati sono rettificati. All sizes are rectified.									
Superficie Finish		LUC	SP	LUC	SP	LUC	SP	LUC	SP
	STATUARIO FINE JL 01	V2	■	■	■	■	■	■	■
	CALACATTA SELECT JL 02	V2	■	■	■	■	■	■	■
	CALACATTA VENA ANTICA JL 03	V2	■	-	■	-	■	■	-
	WASHINGTON JL 04	V2	■	■	■	■	■	■	■
	TUNDRA LITE JL 05	V2	■	■	■	■	■	■	■
	PIETRA GREY JL 06	V2	■	■	■	■	■	■	■
	VERDE ALPI JL 07	V2	-	-	-	-	■	■	-
	Peso lordo per scatola Gross weight per box	27,36	27,36	55,12	55,12	30,30	30,30	61,56	61,56
	Pezzi per scatola Pieces for box	2	2	2	2	2	2	2	2
	mq. scatola sqm. box	1,28	1,28	2,56	2,56	1,44	1,44	2,88	2,88
	Scatole / Full pallet boxes / Full pallet	48	48	16	16	35	35	20	20
	mq. pallet sqm. pallet	61,44	61,44	40,96	40,96	50,40	50,40	57,60	57,60

		± 6 mm					± 12 mm	
Formati Nominali Nominal Sizes		600x1200 24"x48"		1200x2780 48"x110"		Line 1200x2780 48"x110"	* Kit Vein Matching 1200x2780 48"x110"	1620x3240 63¾"x127½"
Tutti i formati sono rettificati, eccetto il formato 1620x3240. All sizes except 1620x3240 are rectified.								
Superficie Finish		PRL	LUC	SP	SP	LUC		SLK
	STATUARIO FINE JL 01	V2	■	■	-	■		-
	CALACATTA SELECT JL 02	V2	■	■	-	■		-
	CALACATTA VENA ANTICA JL 03	V2	-	■	-	■		■
	WASHINGTON JL 04	V2	■	■	■	■		■
	TUNDRA LITE JL 05	V2	■	■	■	-		-
	PIETRA GREY JL 06	V2	■	■	■	-		■
	VERDE ALPI JL 07	V2	■	■	-	-		-
	Peso lordo per scatola Gross weight per box	30,30						
	Pezzi per scatola Pieces for box	2		Please refer to page 588	Please refer to page 588	Please refer to page 588	Please refer to page 588	Please refer to page 588
	mq. scatola sqm. box	1,44						
	Scatole / Full pallet boxes / Full pallet	35						
	mq. pallet sqm. pallet	50,40						

Per tutti i grandi formati è possibile prevedere, su richiesta, e con un lotto minimo l'applicazione di una stuoia in fibra di vetro.
For big sizes, a fibreglass mat can be applied on request, with a minimum production batch.

* Kit Vein Matching (4 pz / 4 pcs)

PRL: adatta esclusivamente per applicazioni a rivestimento. | For wall applications only.

Per garantire elevati standard di sicurezza e le migliori performance tecniche in relazione al loro utilizzo finale (piani cucina, top, arredi), tutte le lastre in formato 1620x3240 in spessore 12mm prevedono l'applicazione di una stuoia in fibra di vetro sul retro della lastra.
All the 1620x3240 slabs in 12mm thickness are provided with a fibreglass mat applied to the back of the slab, to guarantee substantial safety standards and suitable technical performance required for their final use (kitchen countertops, tops, furnishings).

ACCORDIMENTI SPECIFICI PER L'APPLICAZIONE DELLE GRANDI LASTRE IN 6 MM DI SPESSORE: p. 582 | Precautions for 6mm big slabs applications: page 582 | spezifische Anweisungen zur Nutzung der Grossformate in 6mm: seite 582 | Precauciones específicas para la aplicación de las grandes placas en 6 mm de espesor: page 582 | Precautions spécifiques pour la pose des grandes plaques en 6mm d'épaisseur: página 582 | специальные предосторожности для укладки больших плит толщиной 6 мм : страница 582

RACCOMANDAZIONI PER UTILIZZO E CURA DELLE LASTRE COUNTERTOPS p. 583 | How to use and take good care of the COUNTERTOPS slabs p. 583 | Tipps für den Einsatz und die Pflege der Platten COUNTERTOPS p. 583 | Recommandations pour l'utilisation et le soin des plaques COUNTERTOPS p.583 | Recomendaciones para el uso y cuidado de las placas COUNTERTOPS p. 583 | Рекомендации по использованию и уходу за плитками COUNTERTOPS p.583 | 规格的COUNTERTOPS系列陶瓷板的使用和护理建议 583

PEZZI SPECIALI

Special pieces | Sonderstücke | Pièces spéciales | Piezas especiales | специальные изделия | 特殊件

		Battiscopa*		Gradino A*		Gradino A*		Gradino G*	
		72x800 27½"x24"		330x800 13½"x31½"		330x1200 13½"x48"		330x800 13½"x31½"	
Pezzi speciali Special pieces		10		7		4		7	
Superficie Finish		SP	LUC	SP	LUC	LUC	SP	LUC	
	STATUARIO FINE JL 01	■	■	■	■	■	■	■	■
	CALACATTA SELECT JL 02	■	■	■	■	■	■	■	■
	CALACATTA VENA ANTICA JL 03	-	■	-	■	■	-	■	■
	WASHINGTON JL 04	■	■	■	■	■	■	■	■
	TUNDRA LITE JL 05	■	■	■	■	■	■	■	■
	PIETRA GREY JL 06	■	■	■	■	■	■	■	■
	VERDE ALPI JL 07	-	-	-	-	■	-	-	-
	Pezzi per scatola Pieces for box	10		7		4		7	

* Finitura a becco di civetta | One-round edge shaping | Ausführung mit Eckabrundung | Façonnage à bord rond | Acabado canto romo | Плитка с завалом | 鹰嘴边缘处理

		Gradino B ang.		Gradino B		Gradino B	
		330x330 13½"x13½"		330x800 13½"x31½"		330x1200 13½"x48"	
Pezzi speciali Special pieces		4		4		2	
Superficie Finish		SP	LUC	SP	LUC	LUC	
	STATUARIO FINE JL 01	■	■	■	■	■	
	CALACATTA SELECT JL 02	■	■	■	■	■	
	CALACATTA VENA ANTICA JL 03	-	■	-	■	■	
	WASHINGTON JL 04	■	■	■	■	■	
	TUNDRA LITE JL 05	■	■	■	■	■	
	PIETRA GREY JL 06	■	■	■	■	■	
	VERDE ALPI JL 07	-	■	-	-	■	
	Pezzi per scatola Pieces for box	4		4		2	

MY NOTES

.....

.....

.....

.....

.....

Maggiori informazioni
More information



SP: Spazzolata
PRL: Pearl
SLK: Silk
LUC: Lucido | Glossy | Lucida | Lucida | Lustrado | блестящая | 闪亮

DECORI

Decors | Dekore | Decors | Decoros | Декоры | 装饰砖

Mosaico 144 LUC
300x300 / 12"x12"
Tessere 22x22 / 4/5"x4/5"



STATUARIO FINE
JL 01



CALACATTA SELECT
JL 02



CALACATTA VENA ANTICA
JL 03



WASHINGTON
JL 04

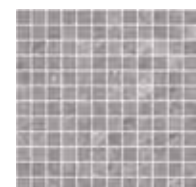

TUNDRA LITE
JL 05

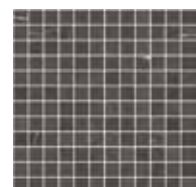

PIETRA GREY
JL 06



VERDE ALPI
JL 07

Mosaico 36T SP
300x300 / 12"x12"
Tessere 48x48 / 2"x2"



STATUARIO FINE
JL 01



CALACATTA SELECT
JL 02



CALACATTA VENA ANTICA
JL 03



WASHINGTON
JL 04

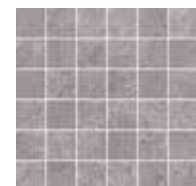

TUNDRA LITE
JL 05

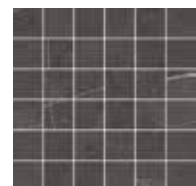

PIETRA GREY
JL 06

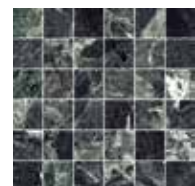

VERDE ALPI
JL 07

MOSAICO 36T, MOSAICO 144T:
Decoro su rete | Mesh-backed decoration | Dekor auf netz | Décor sur filet | Decoración en red | Декор в сети | 网板背帖装饰件

SP: Spazzolata

LUC: Lucido | Glossy | Lucida | Lucida | Lustrado | блестящая | 闪亮

LINE

Una nuova proposta decorativa che esalta le superfici,
per un effetto dalla profondità sorprendente.

A new decorative effect that brings out the astonishing depth of our surfaces.

Line SP RECT
1200x2780 / 48"x110"



WASHINGTON
JL 04



WALL: Washington **JL 04** Line 1200x2780 / 48"x110" SP RECT
FLOOR: Washington **JL 04** 1200x1200 / 48"x48" SP RECT
WASHBASIN: BATHMOOD Delight **JL 04** SP + BATHMOOD Round Bliss Mirror

Pezzi per scatola Pieces for box	
Mosaico 144	6
Mosaico 36T	6

Kit Vein Matching.

Per offrire un servizio sempre più personalizzato, Mirage® mette a disposizione il Kit Vein Matching nei colori Statuario Fine JL 01, Calacatta Select JL 02, Calacatta Vena Antica JL 03 e Washington JL 04 in formato 1200x2780 mm, superficie lucida. Il kit è composto da 4 lastre numerate e dalle grafiche sequenziali ad effetto vena continua.

For an increasingly customised service, Mirage® offers the Vein Matching Kit in JL 01, JL 02, JL 03 and JL 04 colours, in 1200x2780 mm size, glossy finish.

The kit is composed of 4 numbered slabs and sequential patterns that create a continuous vein effect.

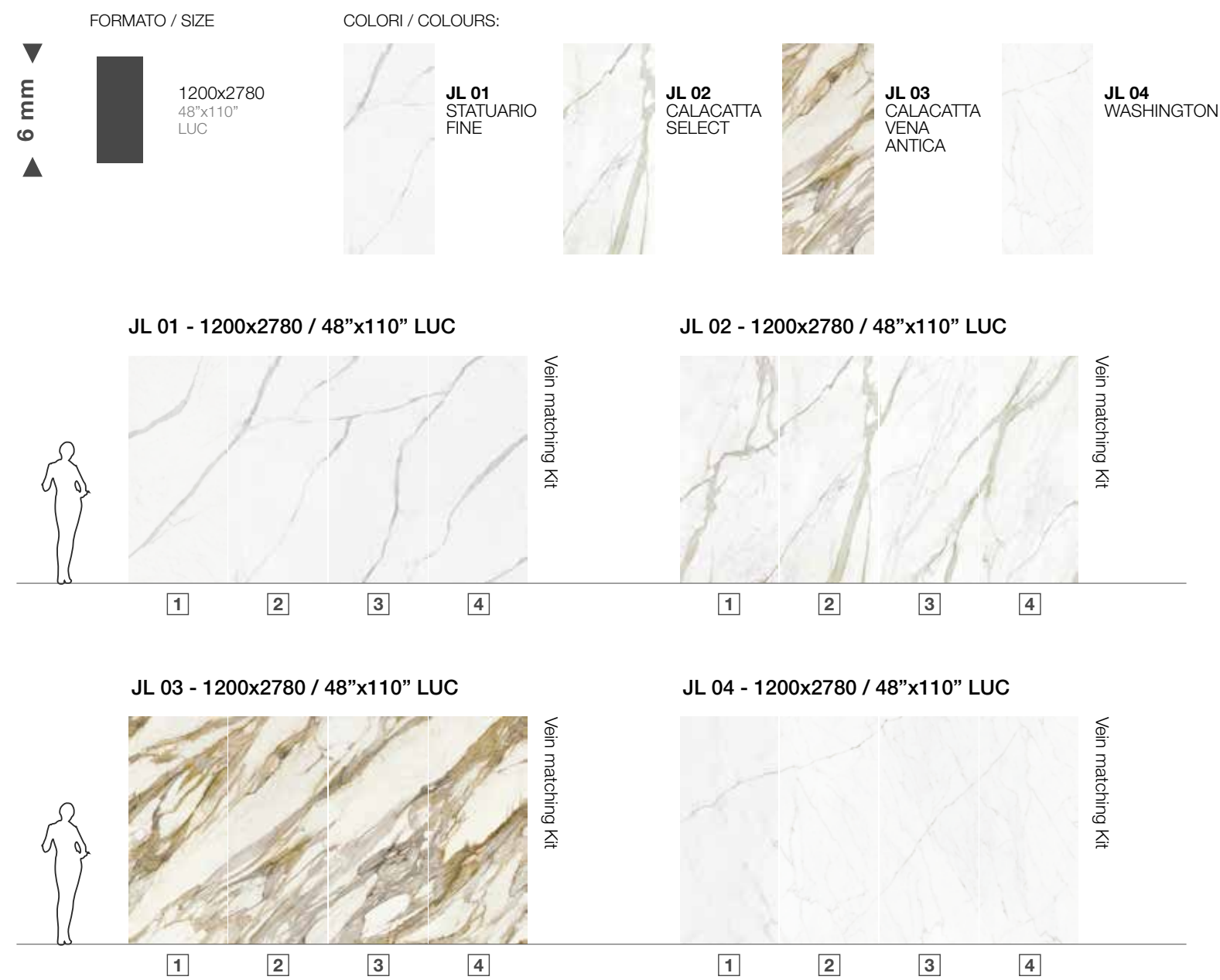

Il processo produttivo non garantisce la continuità nel disegno della venatura tra i vari pezzi spediti. Eventuali disallineamenti tra le venature in continuità sono da considerarsi caratteristica intrinseca del prodotto. L'immagine rappresentata serve a dare un'idea indicativa del prodotto, toni e venature possono essere quindi suscettibili di variazioni.

The production process does not guarantee continuity in the design of the veining among the various pieces provided. Any misalignment between the continuous veining is to be considered an intrinsic characteristic of the product. The image shown is merely indicative; the shades and veinings of the product may be subject to variations.

CARATTERISTICHE TECNICHE

Technical specifications | Technische Eigenschaften | Caractéristiques techniques | Características técnicas | Технические характеристики | 技术特征

STANDARD EN 14411 - G

CARATTERISTICHE TECNICHE TECHNICAL DATA TECHNISCHE DATEN CARACTERISTIQUES TECHNIQUES CARACTERÍSTICAS TÉCNICAS ТЕХНИЧЕСКИЕ ХАРАКТЕРИСТИКИ 技术特征	NORMA STANDARD NORM NORME NORMA НОРМА ЗНАЧЕНИЯ 标准	VALORI PRESCRITTI DALLE NORME EN 14411 - G INTERNATIONAL STANDARDS EN 14411 - G INTERNATIONALE NORMWERTE EN 14411 - G VALEURS PREVUES PAR LES NORMES EN 14411 - G VALORES PREVISTOS POR LAS NORMAS EN 14411 - G ПРЕДУСМОТРЕННЫЕ СТАНДАРТОМ EN 14411-G EN 14411 - G标准规定值	VALORE MEDIO MIRAGE MIRAGE AVERAGE VALUE MIRAGE MITTELWERT VALEUR MOYEN MIRAGE VALOR MEDIO MIRAGE СРЕДНЕЕ ЗНАЧЕНИЕ MIRAGE MIRAGE平均值		
			LUC (GL)	SP (UGL)	PRL (GL)
CARATTERISTICHE DIMENSIONALI - SIZE CHARACTERISTICS - MASSEIGENSCHAFTEN DETERMINATION DES CARACTERISTIQUES DIMENSIONNELLES - CARACTERÍSTICAS DIMENSIONALES - РАЗМЕРНЫЕ ХАРАКТЕРИСТИКИ - 尺寸特征					
LATI SIDES - SEITEN COTES - CANTOS РАЗМЕРЫ СТОРОН - 侧边	EN ISO 10545-2	± 0,3% MAX (± 1,0 mm MAX)	CONFORME COMPLYING		
SPESSORE THICKNESS - DICKE EPAISSEUR - ESPESOR ТОЛЩИНА - 厚度	EN ISO 10545-2	± 5,0% MAX (± 0,5 mm MAX)	CONFORME COMPLYING		
RETTILINEITÀ DEGLI SPIGOLI STRAIGHTNESS OF SIDES - GERADLINIGKEIT DER KANTEN RECTITUDE DES ARETES - RECTITUD DE LOS CANTOS КОСОУГОЛЬНОСТЬ - 边角平直度	EN ISO 10545-2	± 0,3% MAX (± 0,8 mm MAX)	CONFORME COMPLYING		
ORTOGONALITÀ RECTANGULARITY - RECHTWINKLIGKEIT PERPENDICULARITE - ORTOGONALIDAD КРИВИЗНА СТОРОН - 直角度	EN ISO 10545-2	± 0,3% MAX (± 1,5 mm MAX)	CONFORME COMPLYING		
PLANARITÀ SURFACE FLATNESS - EBENFLÄCHIGKEIT PLANEITE DE SURFACE - PLANEIDAD КРИВИЗНА ЛИЦЕВОЙ ПОВЕРХНОСТИ - 平整度	EN ISO 10545-2	± 0,4% MAX (± 1,8 mm MAX)	CONFORME COMPLYING		
ASSORBIMENTO D'ACQUA WATER ABSORPTION - WASSERAUFNAHME ABSORPTION D'EAU - ABSORCIÓN DE AGUA ВОДОПОГЛОЩЕНИЕ - 吸水率	EN ISO 10545-3	≤ 0,5%	≤ 0,1%		
RESISTENZA ALLA FLESSIONE FLEXION RESISTANCE - BIEGEFESTIGKEIT RESISTANCE A LA FLEXION - RESISTENCIA A LA FLEXIÓN ПРЕДЕЛ ПРОЧНОСТИ ПРИ ИЗГИБЕ - 抗弯强度	EN ISO 10545-4	S ≥ 700 N (< 7,5 mm) S ≥ 1.300 N (> 7,5 mm) R ≥ 0,48 N/mm²	±6 mm: S≥1100N R≥48 N/mm² ±9 mm: S≥2500N R≥50 N/mm²		
RESISTENZA ALL'URTO IMPACT RESISTANCE - STOSSFESTIGKEIT RESISTANCE AUX CHOCS - RESISTENCIA A LOS GOLPES УДАРОСТОЙКОСТЬ - 抗冲击强度	EN ISO 10545-5	VALORE DICHIARATO DECLARED VALUE	> 0,80		
RESISTENZA ALL'ABRASIONE ABRASION RESISTANCE - ABRIEBFESTIGKEIT RESISTANCE A L'ABRASION - RESISTENCIA A LA ABRASIÓN СТОЙКОСТЬ К ИСТИРАНИЮ - 耐磨强度	EN ISO 10545-6	≤ 175 mm³	< 150 mm³		
COEFFICIENTE DI DILATAZIONE TERMICA LINEARE COEFFICIENT OF LINEAR THERMAL-EXPANSION - LINEARER WÄRMEAUDEHNUNGSKOEFFIZIENT COEFFICIENT DE DILATATION THERMIQUE LINEAIRE - COEFICIENTE DE DILATACIÓN TÉRMICA LINEAL КОЭФФИЦИЕНТ ЛИНЕЙНОГО ТЕРМИЧЕСКОГО РАСШИРЕНИЯ - 线性热膨胀系数	EN ISO 10545-8	-	α 6,2x10 ⁻⁶ /°C		
RESISTENZA AGLI SBALZI TERMICI RESISTANCE TO THERMAL SHOCKS - BESTÄNDIGKEIT GEGEN TEMPERATURSCHWANKUNGEN RESISTANCE AUX CHOCS THERMIQUES - RESISTENCIA A LOS CHOQUES TÉRMICOS СТОЙКОСТЬ К ПЕРЕПАДАМ ТЕМПЕРАТУРЫ - 耐热突变性	EN ISO 10545-9	TEST SUPERATO SECONDO EN ISO 10545-1 PASS ACCORDING EN ISO 10545-1	NESSUN DANNO NO DAMAGE		
RESISTENZA AL GELO FROST RESISTANCE - FROSTBESTÄNDIGKEIT RESISTANCE AU GEL - RESISTENCIA AL HIELO МОРОЗОСТОЙКОСТЬ - 耐冻性	EN ISO 10545-12	TEST SUPERATO SECONDO EN ISO 10545-1 PASS ACCORDING EN ISO 10545-1	NESSUN DANNO NO DAMAGE		
RESISTENZA ALL'ATTACCO CHIMICO RESISTANCE TO CHEMICALS - CHEMIKALIENBESTÄNDIGKEIT RESISTANCE A L'ATTAQUE CHIMIQUE - RESISTENCIA QUÍMICA ХИМИЧЕСКАЯ СТОЙКОСТЬ - 耐化学品作用	EN ISO 10545-13	B MIN.	A LA	A LA HA	A LA
RESISTENZA ALL'ABRASIONE SUPERFICIALE SURFACE ABRASION RESISTANCE - ABRIEBFESTIGKEIT DER OBERFLÄCHE RESISTANCE À L'ABRASION SUPERFICIELLE - RESISTENCIA A LA ABRASIÓN SUPERFICIAL ХИМИЧЕСКАЯ СТОЙКОСТЬ - 耐表面磨损	EN ISO 10545-7	-	LUC PEI 5 (JL 01 - 02 - 03 - 04) PEI 4 (JL 05) PEI 3 (JL 06 - 07)		
RESISTENZA ALLE MACCHIE RESISTANCE TO STAINS - FLECKENBESTÄNDIGKEIT RESISTANCE AUX TACHES - RESISTENCIA A LAS MANCHAS УСТОЙЧИВОСТЬ К ПЯТНООБРАЗОВАНИЮ - 防污性	EN ISO 10545-14	VALORE DICHIARATO DECLARED VALUE	5	5	5
CESSIONE DI PIOMBO E CADMIO LEAD AND CADMIUM DISCHARGE - ABGABE VON BLEI UND CADMIUM PERTE DE PLOMB ET CADMIUM - CESIÓN DE PLOMO Y CADMIO ВЫДЕЛЕНИЕ СВИНЦА И КАДМИЯ - 铅和镉的排放	EN ISO 10545-15	VALORE DICHIARATO DECLARED VALUE	< AL LIMITE DI RILEVAMENTO < THAN INSTRUMENT LIMIT		
SCIVOLOSITÀ SKID RESISTANCE - RUTSCHWERT GLISSANCE - ADHERENCIA СКОЛЬЗКОСТЬ - 防滑性			LUC	SP	PRL
	DM 236/89 BCRA	> 0,40	-	> 0,40	-
	ANSI A326.3	Wet and Dry	-	≥ 0,42	-
	AS 4586	-	-	P2	-
	DIN 51130	-	-	R9	-
	DIN 51097	-	-	-	-
	UNE 41901	≥ CL1	-	CL1	-
	BS 7976 sl.96-4S	Wet and Dry	-	-	-
	BS 7976 sl.55-TRL	Wet and Dry	-	-	-

Per i certificati specifici, contattare Mirage SpA - For specific certificates, please contact Mirage SpA - Für die speziellen Zertifikate wenden Sie sich bitte an Mirage SpA - Pour les certificats spécifiques, veuillez contacter Mirage SpA - Para los certificados específicos, contactar Mirage SpA - Для сертификатов обращайтесь в компанию Mirage SpA - 关于具体的证书,请联系 Mirage SpA 公司

* Le superfici LUC e PRL possono essere soggette a graffi se in contatto con materiali più duri (es sassi, frammenti di piastrella, etc...)
Luc and PRL finishes can be subjected to scratches if in contact with harder materials (eg stones, tile gragments, etc...)



Wild JP 05 200x1200 / 8"x48" NAT RECT

JURUPA

Rediscover the allure of OAK, with an alternative approach: grouting, scratches and gnarls for a contemporary effect.

Jurupa comes in 5 colours, 3 sizes, Natural R9 finish for indoors, Grip R11 and Radiale R11 for outdoors, guaranteeing maximum coordinability within the collection.



FLOOR: Master JP 03 200x1200 / 8"x48" NAT RECT
WALL and TOP: NORR Grå RR 02 1200x2780 NAT
ISLAND TOP: JEWELS Statuario Venato JW 14 1620x3240 / 63¾"x127½" LUC



FLOOR: Camp **JP 04** 300x1200 / 12"x48" RD RECT EVO_2/E" \pm 20 mm
WALL: Camp **JP 04** 200x1200 / 8"x48" NAT RECT

COLORI

Colours | Farben | Couleurs | Colores | Цветов | 种颜色



Basic
JP 01



Cool
JP 02



Master
JP 03



Camp
JP 04



Wild
JP 05



FLOOR: Camp **JP 04** 200x1200 / 8"x48" NAT RECT
WALL and TUB: GLOCAL Absolute **GC 06** 1200x2780 / 48"x110" SP RECT
WALL SHOWER and TOP: Camp **JP 04** 200x1200 / 8"x48" NAT RECT



EFFETTO LEGNO

COLORI

Colours | Farben | Couleurs | Colores | Цветов | 种颜色

BASIC JP 01



Formati Nominali Nominal Sizes		Superficie Finish	Spessore mm Thickness mm
200x1200 / 8"x48"		NAT / GP RECT	9
300x2400 / 12"x96"		NAT RECT	9

Stucchi consigliati Recommended grouts		
KERAKOLL	43	
MAPEI	112 Grigio Medio	
LATICRETE	04 Sterling Silver	



CAMP JP 04



Formati Nominali Nominal Sizes		Superficie Finish	Spessore mm Thickness mm
200x1200 / 8"x48"		NAT / GP RECT	9
300x2400 / 12"x96"		NAT RECT	9
600x600 / 24"x24"		RD RECT	20
300x1200 / 12"x48"		RD RECT	20

Stucchi consigliati Recommended grouts		
KERAKOLL	26	
MAPEI	134 Seta	
LATICRETE	78 Sterling Silver	



COOL JP 02

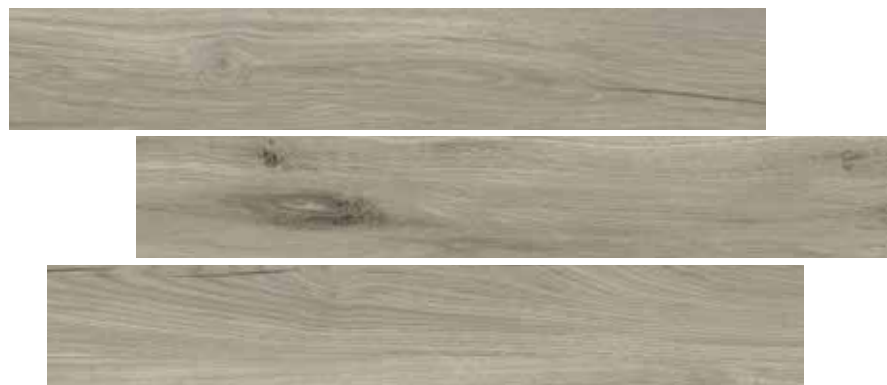

Formati Nominali Nominal Sizes		Superficie Finish	Spessore mm Thickness mm
200x1200 / 8"x48"		NAT / GP RECT	9
300x2400 / 12"x96"		NAT RECT	9
600x600 / 24"x24"		RD RECT	20
300x1200 / 12"x48"		RD RECT	20

Stucchi consigliati Recommended grouts		
KERAKOLL	45	
MAPEI	111 Grigio Argento	
LATICRETE	89 Smoke Grey	



WILD JP 05



Formati Nominali Nominal Sizes		Superficie Finish	Spessore mm Thickness mm
200x1200 / 8"x48"		NAT / GP RECT	9
300x2400 / 12"x96"		NAT RECT	9

Stucchi consigliati Recommended grouts		
KERAKOLL	26	
MAPEI	136 Fango	
LATICRETE	45 Raven	



MASTER JP 03



Formati Nominali Nominal Sizes		Superficie Finish	Spessore mm Thickness mm
200x1200 / 8"x48"		NAT / GP RECT	9
300x2400 / 12"x96"		NAT RECT	9
600x600 / 24"x24"		RD RECT	20
300x1200 / 12"x48"		RD RECT	20

Stucchi consigliati Recommended grouts		
KERAKOLL	30	
MAPEI	113 Grigio Argento	
LATICRETE	34 Sand Stone	



NAT: Naturale | Natural | Natur/unpoliert | Naturelle | Natural | Натуральный | 天然

GP: Grip

RD: Radiale

RIASSUNTIVO FORMATI ED IMBALLI

Summary of sizes and packaging | Übersicht über Formate und Verpackungen | Récapitulatif formats et emballages
Sinóptico de formatos y embalajes | Краткая информация о форматах и упаковках | 规格和包装概述

		200x1200 8"x48"		300x2400 12"x96"	
Formati Nominali Nominal Sizes					
Tutti i formati sono rettificati. All sizes are rectified.					
Superficie Finish		NAT		GP	
BASIC JP 01		V2	■	■	■
COOL JP 02		V2	■	■	■
MASTER JP 03		V2	■	■	■
CAMP JP 04		V2	■	■	■
WILD JP 05		V2	■	■	■
Peso lordo per scatola Gross weight per box		30,00		30,92	
Pezzi per scatola Pieces for box		6		6	
mq. scatola sqm. box		1,44		1,44	
Scatole / Full pallet boxes / Full pallet		32		32	
mq. pallet sqm. pallet		46,08		46,08	

		300x1200 12"x48"		600x600 24"x24"	
Formati Nominali Nominal Sizes					
Tutti i formati sono rettificati. All sizes are rectified.					
Superficie Finish		RD		RD	
BASIC JP 01		V2	-	-	-
COOL JP 02		V2	■	■	■
MASTER JP 03		V2	■	■	■
CAMP JP 04		V2	■	■	■
WILD JP 05		V2	-	-	-
Peso lordo per scatola Gross weight per box		32,00		31,15	
Pezzi per scatola Pieces for box		2		2	
mq. scatola sqm. box		0,72		0,72	
Scatole / Full pallet boxes / Full pallet		36		30	
mq. pallet sqm. pallet		25,92		21,60	

NAT: Naturale | Natural | Natur/unpoliert | Naturelle | Natural | Натуральный | 天然
GP: Grip
RD: Radiale

PEZZI SPECIALI

Special pieces | Sonderstücke | Pièces spéciales | Piezas especiales | специальные изделия | 特殊件

		Battiscopa*		Gradino A*	
Pezzi speciali Special pieces		72x600 27/8"x24"		330x1200 131/4"x48"	
Superficie Finish		NAT		NAT	
BASIC JP 01		■		■	
COOL JP 02		■		■	
MASTER JP 03		■		■	
CAMP JP 04		■		■	
WILD JP 05		■		■	
Pezzi per scatola Pieces for box		10		4	

* Finitura a becco di civetta | One-round edge shaping | Ausführung mit Eckabrundung | Façonnage à bord rond | Acabado canto romo | Плитка с завалом | 鹰嘴边缘处理

DECORI

Decors | Dekore | Decors | Decoros | Декоры | 装饰砖

Leaf NAT
223x260 / 83/4"x101/4"



Pezzi per scatola
Pieces for box
Leaf 6

MY NOTES

.....

.....

.....

.....

.....

Maggiori informazioni
More information





CARATTERISTICHE TECNICHE

Technical specifications | Technische Eigenschaften | Caractéristiques techniques | Características técnicas | Технические характеристики | 技术特征

STANDARD EN 14411 - G

CARATTERISTICHE TECNICHE TECHNISCHE DATEN TECHNISCHE DATEN CARACTERISTIQUES TECHNIQUES CARACTERÍSTICAS TÉCNICAS ТЕХНИЧЕСКИЕ ХАРАКТЕРИСТИКИ 技术特征		NORMA STANDARD NORM NORME NORMA ЗНАЧЕНИЯ 标准	VALORI PRESCRITTI DALLE NORME EN 14411 - G INTERNATIONAL STANDARDS EN 14411 - G INTERNATIONALE NORMWERTE EN 14411 - G VALEURS PREVUES PAR LES NORMES EN 14411 - G VALORES PREVISTOS POR LAS NORMAS EN 14411 - G ПРЕДУСМОТРЕННЫЕ СТАНДАРТОМ EN 14411-G EN 14411 - G标准规定值	*VALORE MEDIO MIRAGE MIRAGE AVERAGE VALUE MIRAGE MITTELWERT VALEURS MOYEN MIRAGE VALOR MEDIO MIRAGE СРЕДНЕЕ ЗНАЧЕНИЕ MIRAGE MIRAGE平均值		
				NAT	GP	RD 20mm
CARATTERISTICHE DIMENSIONALI - SIZE CHARACTERISTICS - MASSEIGENSCHAFTEN DETERMINATION DES CARACTERISTIQUES DIMENSIONNELLES - CARACTERÍSTICAS DIMENSIONALES - РАЗМЕРНЫЕ ХАРАКТЕРИСТИКИ - 尺寸特征						
LATI SIDES - SEITEN COTES - CANTOS РАЗМЕРЫ СТОРОН - 側边	EN ISO 10545-2	± 0,3% MAX (± 1,0 mm MAX)	CONFORME COMPLYING			
SPESSORE THICKNESS - DICKE EPAISSEUR - ESPESOR ТОЛЩИНА - 厚度	EN ISO 10545-2	± 5,0% MAX (± 0,5 mm MAX)	CONFORME COMPLYING			
RETTILINEITÀ DEGLI SPIGOLI STRAIGHTNESS OF SIDES - GERADLINIGKEIT DER KANTEN RECTITUDE DES ARETES - RECTITUD DE LOS CANTOS КОСОУГОЛЬНОСТЬ - 边角平直度	EN ISO 10545-2	± 0,3% MAX (± 0,8 mm MAX)	CONFORME COMPLYING			
ORTOGONALITÀ RECTANGULARITY - RECHTWINKLIGKEIT PERPENDICULARITÉ - ORTOGONALIDAD КРИВИЗНА СТОРОН - 直角度	EN ISO 10545-2	± 0,3% MAX (± 1,5 mm MAX)	CONFORME COMPLYING			
PLANARITÀ SURFACE FLATNESS - EBENFLÄCHIGKEIT PLANEITE DE SURFACE - PLANEIDAD КРИВИЗНА ЛИЦЕВОЙ ПОВЕРХНОСТИ - 平整度	EN ISO 10545-2	± 0,4% MAX (± 1,8 mm MAX)	CONFORME COMPLYING			
ASSORBIMENTO D'ACQUA WATER ABSORPTION - WASSERAUFNAHME ABSORPTION D'EAU - ABSORCIÓN DE AGUA ВОДОПОГЛОЩЕНИЕ - 吸水率	EN ISO 10545-3	≤ 0,5%	≤ 0,1%			
RESISTENZA ALLA FLESSIONE FLEXION RESISTANCE - BIEGEFESTIGKEIT RESISTANCE A LA FLEXION - RESISTENCIA A LA FLEXIÓN ПРЕДЕЛ ПРОЧНОСТИ ПРИ ИЗГИБЕ - 抗弯强度	EN ISO 10545-4	S ≥ 700 N (< 7,5 mm) S ≥ 1.300 N (> 7,5 mm) R ≥ 35 N/mm².	±9 mm: S≥2.400N R≥48N/mm² ±20 mm: S≥12.500N R≥48N/mm²			
RESISTENZA ALL'URTO IMPACT RESISTANCE - STOSSFESTIGKEIT RESISTANCE AUX CHOCES - RESISTENCIA A LOS GOLPES УДАРОСТОЙКОСТЬ - 抗冲击强度	EN ISO 10545-5	VALORE DICHIARATO DECLARED VALUE	> 0,48			
RESISTENZA ALL'ABRAZIONE ABRASION RESISTANCE - ABRIEBFESTIGKEIT RESISTANCE A L'ABRASION - RESISTENCIA A LA ABRASIÓN СТОЙКОСТЬ К ИСТИРАНИЮ - 耐磨强度	EN ISO 10545-6	≤ 175 mm³	< 150 mm³			
COEFFICIENTE DI DILATAZIONE TERMICA LINEARE COEFFICIENT OF LINEAR THERMAL-EXPANSION - LINEARER WÄRMEAUDEHNUNGSKOEFFIZIENT COEFFICIENT DE DILATATION THERMIQUE LINEAIRE - COEFICIENTE DE DILATACIÓN TÉRMICA LINEAL КОЭФФИЦИЕНТ ЛИНЕЙНОГО ТЕРМИЧЕСКОГО РАСТЯЖЕНИЯ - 线性热膨胀系数	EN ISO 10545-8	-	α=6,6x10 ⁻⁶ °C ⁻¹			
RESISTENZA AGLI SBALZI TERMICI RESISTANCE TO THERMAL SHOCKS - BESTÄNDIGKEIT GEGEN TEMPERATURSCHWANKUNGEN RESISTANCE AUX CHOCES THERMIQUES - RESISTENCIA A LOS CHOQUES TÉRMICOS СТОЙКОСТЬ К ПЕРЕПАДАМ ТЕМПЕРАТУРЫ - 耐热突变性	EN ISO 10545-9	TEST SUPERATO SECONDO EN ISO 10545-1 PASS ACCORDING EN ISO 10545-1	NESSUN DANNO NO DAMAGE			
RESISTENZA AL GELO FROST RESISTANCE - FROSTBESTÄNDIGKEIT RESISTANCE AU GEL - RESISTENCIA AL HIELO МОРОЗОСТОЙКОСТЬ - 耐冻性	EN ISO 10545-12	TEST SUPERATO SECONDO EN ISO 10545-1 PASS ACCORDING EN ISO 10545-1	NESSUN DANNO NO DAMAGE			
RESISTENZA ALL'ATTACCO CHIMICO RESISTANCE TO CHEMICALS - CHEMIKALIENBESTÄNDIGKEIT RESISTANCE A L'ATTAQUE CHIMIQUE - RESISTENCIA QUÍMICA ХИМИЧЕСКАЯ СТОЙКОСТЬ - 耐化学品作用	EN ISO 10545-13	B MIN.	A LA HA			
RESISTENZA ALLE MACCHIE RESISTANCE TO STAINS - FLECKENBESTÄNDIGKEIT RESISTANCE AUX TACHES - RESISTENCIA A LAS MANCHAS УСТОЙЧИВОСТЬ К ПЯТНООБРАЗОВАНИЮ - 防污性	EN ISO 10545-14	VALORE DICHIARATO DECLARED VALUE	5			
CESSIONE DI PIOMBO E CADMIO LEAD AND CADMIUM DISCHARGE - ABGABE VON BLEI UND CADMIUM PERTE DE PLOMB ET CADMIUM - CESIÓN DE PLOMO Y CADMIO ВЫДЕЛЕНИЕ СВИНЦА И КАДМИЯ - 铅和镉的排放	EN ISO 10545-15	VALORE DICHIARATO DECLARED VALUE	< AL LIMITE DI RILEVAMENTO < THAN INSTRUMENT LIMIT			
				NAT	GP	RD 20mm
		DM 236/89 BCRA	> 0,40	> 0,40	> 0,40	> 0,40
		ANSI A326.3	Wet and Dry	≥ 0,42	≥ 0,55	≥ 0,55
		AS 4586	-	P2	P4	-
		DIN 51130	-	R9	R11	R11
		DIN 51097	-	A	A+B+C	A+B+C
		UNE 41901	≥ CL1	CL1	CL3	-
		BS 7976 sl.96-4S	Wet and Dry	-	≥ 0,36	-
		BS 7976 sl.55-TRL	Wet and Dry	-	≥ 0,36	-
SCIVOLOSITÀ SKID RESISTANCE - RUTSCHWERT GLISSANCE - ADHERENCIA СКОЛЬЗКОСТЬ - 防滑性						

Per i certificati specifici, contattare Mirage SpA - For specific certificates, please contact Mirage SpA - Für die speziellen Zertifikate wenden Sie sich bitte an Mirage SpA - Pour les certificats spécifiques, veuillez contacter Mirage SpA
Para los certificados específicos, contactar Mirage SpA - Для сертификатов обращайтесь в компанию Mirage SpA - 关于具体的证书, 请联系Mirage SpA公司

EFFETTO LEGNO



FLOOR: Spice **KA 04** 250x1500 / 10"x60" SP RECT
TABLE TOP: WANDERLUST Calacatta Copper **WA 01** LUC

KAO

A collection with delicate and elegantly classic patterns with perfectly balanced contrasts and knots.

KAO comes in 7 natural colours, running from cream to olive passing through the more classic shades of wood.



FLOOR: Dew **KA 01** 200x1200 / 8"x48" SP RECT



COLORI
Colours | Farben | Couleurs | Colores | Цветов | 种颜色

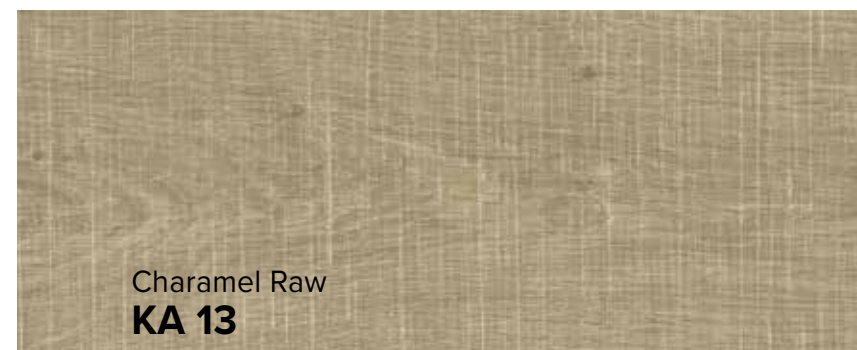



FLOOR: Hazelnut **KA 02** 250x1500 / 10"x60" SP RECT
OUTDOOR FLOOR: Hazelnut **KA 02** 300x1200 / 12"x48" RD RECT EVO_2/E" ₹ 20 mm
COUNTER: COSMOPOLITAN Calacatta Gold **CP 02** LUC



COLORI

Colours | Farben | Couleurs | Colores | Цветов | 种颜色

Dew KA 01



	Formati Nominali Nominal Sizes		Superficie Finish		Spessore mm Thickness mm
	200x1200 / 8"x48"		SP / NAT RECT		9
	250x1500 / 10"x60"		SP RECT		9
	Stucchi consigliati Recommended grouts				
	KERAKOLL	43			
	MAPEI	123 Ancient White			
	LATICRETE	78 Sterling Silver			



Spice KA 04

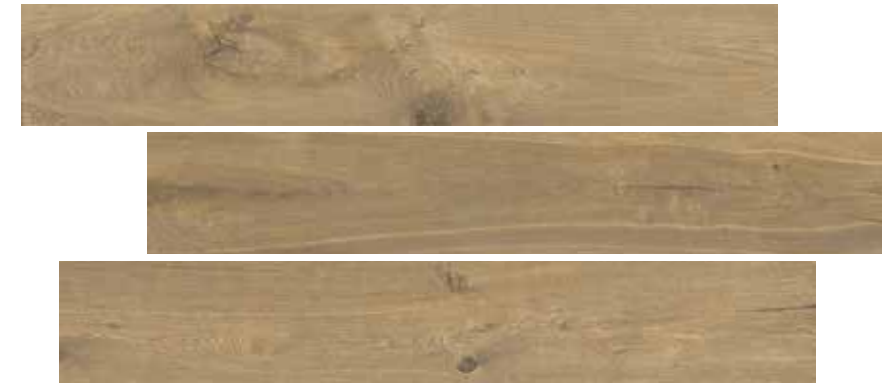

	Formati Nominali Nominal Sizes		Superficie Finish		Spessore mm Thickness mm	
					200x1200 / 8"x48"	9
					200x1800 / 8"x72"	9
					250x1500 / 10"x60"	9
					300x1200 / 12"x48"	20
	Stucchi consigliati Recommended grouts					
	KERAKOLL	31				
	MAPEI	135 Polvere Dorata				
	LATICRETE	55 Tawny				

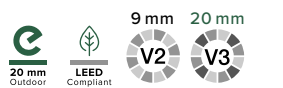

Hazeknut KA 02



	Formati Nominali Nominal Sizes		Superficie Finish		Spessore mm Thickness mm	
					200x1200 / 8"x48"	9
					200x1800 / 8"x72"	9
					250x1500 / 10"x60"	9
					300x1200 / 12"x48"	20
	Stucchi consigliati Recommended grouts					
	KERAKOLL	31				
	MAPEI	188 Biscuit				
	LATICRETE	81 Buttercream				



Cocoa KA 05

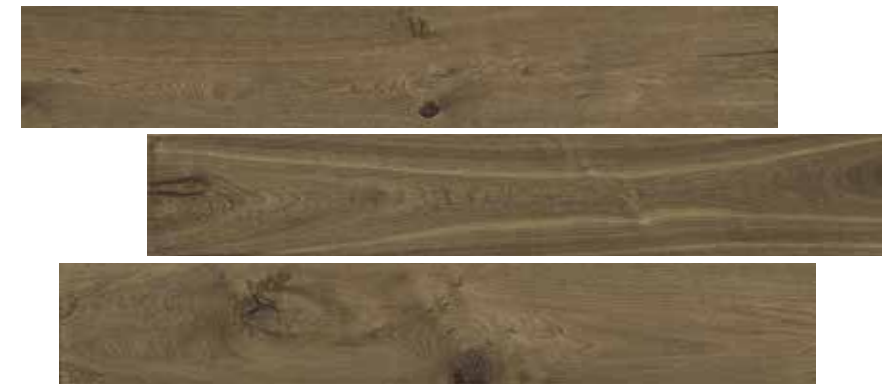

	Formati Nominali Nominal Sizes		Superficie Finish		Spessore mm Thickness mm	
					200x1200 / 8"x48"	9
					250x1500 / 10"x60"	9
	Stucchi consigliati Recommended grouts					
	KERAKOLL	33				
	MAPEI	136 Mud				
	LATICRETE	45 Raven				



Charamel KA 03



	Formati Nominali Nominal Sizes		Superficie Finish		Spessore mm Thickness mm	
					200x1200 / 8"x48"	9
					200x1800 / 8"x72"	9
					250x1500 / 10"x60"	9
					300x1200 / 12"x48"	20
	Stucchi consigliati Recommended grouts					
	KERAKOLL	31				
	MAPEI	133 Sabia				
	LATICRETE	81 Buttercream				



Hazelnut Raw KA 12



	Formati Nominali Nominal Sizes		Superficie Finish		Spessore mm Thickness mm	
					200x1200 / 8"x48"	9
					300x1200 / 12"x48"	20
	Stucchi consigliati Recommended grouts					
	KERAKOLL	31				
	MAPEI	188 Biscuit				
	LATICRETE	81 Buttercream				



COLORI

Colours | Farben | Couleurs | Colores | Цветов | 种颜色

Charamel Raw **KA 13**



Formati Nominali Nominal Sizes	Superficie Finish	9 mm 20 mm V2 V3

Stucchi consigliati Recommended grouts	KERAKOLL	31	
	MAPEI	133 Sabia	
	LATICRETE	81 Buttercream	

Spice Raw **KA 14**



Formati Nominali Nominal Sizes	Superficie Finish	9 mm 20 mm V2 V3

Stucchi consigliati Recommended grouts	KERAKOLL	31	
	MAPEI	135 Polvere Dorata	
	LATICRETE	55 Tawny	



FLOOR: Hazelnut Raw **KA 12** 200x1200 / 8"x48" SP RECT

RIASSUNTIVO FORMATI ED IMBALLI

Summary of sizes and packaging | Übersicht über Formate und Verpackungen | Récapitulatif formats et emballages
Sinóptico de formatos y embalajes | Краткая информация о форматах и упаковках | 规格和包装概述

		± 9 mm			
Formati Nominali Nominal Sizes		200x1200 8'x48"	200x1800 8'x72"	250x1500 10'x60"	
Tutti i formati sono rettificati. All sizes are rectified.					
Superficie Finish		SP	NAT	SP	SP
DEW KA 01	V2	■	■	-	■
HAZEKNUT KA 02	V2	■	■	■	■
CHARAMEL KA 03	V2	■	■	■	■
SPICE KA 04	V2	■	■	■	■
COCOA KA 05	V2	■	■	-	■
HAZELNUT RAW KA 12	V2	■	-	-	-
CHARAMEL RAW KA 13	V2	■	-	-	-
SPICE RAW KA 14	V2	■	-	-	-
Peso lordo per scatola Gross weight per box		30,00	30,00	-	23,58
Pezzi per scatola Pieces for box		6	6	-	3
mq. scatola sqm. box		1,44	1,44	-	1,125
Scatole / Full pallet boxes / Full pallet		32	32	-	30
mq. pallet sqm. pallet		46,08	46,08	-	33,75

		± 20 mm	
Formati Nominali Nominal Sizes		300x1200 12'x48"	
Tutti i formati sono rettificati. All sizes are rectified.			
Superficie Finish		RD	
DEW KA 01	V3	-	
HAZEKNUT KA 02	V3	■	
CHARAMEL KA 03	V3	■	
SPICE KA 04	V3	■	
COCOA KA 05	V3	-	
HAZELNUT RAW KA 12	V3	■	
CHARAMEL RAW KA 13	V3	■	
SPICE RAW KA 14	V3	■	
Peso lordo per scatola Gross weight per box		32,00	
Pezzi per scatola Pieces for box		2	
mq. scatola sqm. box		0,72	
Scatole / Full pallet boxes / Full pallet		36	
mq. pallet sqm. pallet		25,20	

PEZZI SPECIALI

Special pieces | Sonderstücke | Pièces spéciales | Piezas especiales | специальные изделия | 特殊件

	Battiscopa*	Gradino A*	Gradino B
Pezzi speciali Special pieces	72x600 27/8"x24"	330x1200 131/8"x48"	330x1200 131/8"x48"
Superficie Finish	SP	SP	NAT
DEW KA 01	■	■	■
HAZEKNUT KA 02	■	■	■
CHARAMEL KA 03	■	■	■
SPICE KA 04	■	■	■
COCOA KA 05	■	■	■
HAZELNUT RAW KA 12	■	■	■
CHARAMEL RAW KA 13	■	■	■
SPICE RAW KA 14	■	■	■
Pezzi per scatola Pieces for box	10	4	2

* Finitura a becco di civetta | One-round edge shaping | Ausführung mit Eckabrundung
Façonnage à bord rond | Acabado canto romo | Плитка с завалом | 鹰嘴边缘处理

MY NOTES

.....

.....

.....

.....

.....

Maggiori informazioni
More information



NAT: Naturale | Natural | Natur/unpoliert | Naturelle | Natural | Натуральный | 天然
SP: Spazzolata
RD: Radiale

DECORI

Decors | Dekore | Decors | Decoros | Декоры | 装饰砖

Fusion SP
1200x2780 / 48"x110"
± 6 mm



HAZEKNUT **KA 02**



CHARAMEL **KA 03**



SPICE **KA 04**

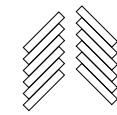

Nest SP
210x420 / 8 1/2"x17"



DEW **KA 01**
DX-SX



HAZEKNUT **KA 02**
DX-SX



CHARAMEL **KA 03**
DX-SX



SPICE **KA 04**
DX-SX



COCOA **KA 05**
DX-SX



HAZEKNUT RAW **KA 12**
DX-SX



CHARAMEL RAW **KA 13**
DX-SX



SPICE RAW **KA 14**
DX-SX

ACCORGIMENTI SPECIFICI PER L'APPLICAZIONE DELLE GRANDI LASTRE IN 6 MM DI SPESSORE: p. 556 | Precautions for 6mm big slabs applications: page 556 | spezifische Anweisungen zur Nutzung der Grossformate in 6mm: seite 556 | Precauciones específicas para la aplicación de las grandes placas en 6 mm de espesor: page 556 | Precautions spécifiques pour la pose des grandes plaques en 6mm d'épaisseur: página 556 | специальные предосторожности для укладки больших плит толщиной 6 мм : страница 556

NEST:
Decoro su rete. | Mesh-backed decoration. | Dekor auf netz. | Décor sur filet. | Decoración en red. | Декор в сети. | 网板背帖装饰件



Pezzi per scatola
Pieces for box

Nest 6 (3dx + 3sx)

Fusion -



FLOOR: Spice KA 04 200x1200 / 8"x48" SP RECT

CARATTERISTICHE TECNICHE

Technical specifications | Technische Eigenschaften | Caractéristiques techniques | Características técnicas | Технические характеристики | 技术特征

STANDARD EN 14411 - G

	CARATTERISTICHE TECNICHE TECHNICAL DATA TECHNISCHE DATEN CARACTERISTIQUES TECHNIQUES CARACTERÍSTICAS TÉCNICAS ТЕХНИЧЕСКИЕ ХАРАКТЕРИСТИКИ 技术特征	NORMA STANDARD NORM NORME NORMA ЗНАЧЕНИЯ 标准	VALORI PRESCRITTI DALLE NORME EN 14411 - G INTERNATIONAL STANDARDS EN 14411 - G INTERNATIONALE NORMWERTE EN 14411 - G VALEURS PREVUES PAR LES NORMES EN 14411 - G VALORES PREVISTOS POR LAS NORMAS EN 14411 - G ПРЕДУСМОТРЕННЫЕ СТАНДАРТОВ EN 14411-G EN 14411 - G标准规定值	*VALORE MEDIO MIRAGE MIRAGE AVERAGE VALUE MIRAGE MITTELWERT VALEURS MOYEN MIRAGE VALORES MEDIO MIRAGE СРЕДНЕЕ ЗНАЧЕНИЕ MIRAGE MIRAGE平均值			
				SP	NAT	RD 20mm	
	CARATTERISTICHE DIMENSIONALI - SIZE CHARACTERISTICS - MASSEIGENSCHAFTEN DETERMINATION DES CARACTERISTIQUES DIMENSIONNELLES - CARACTERÍSTICAS DIMENSIONALES - РАЗМЕРНЫЕ ХАРАКТЕРИСТИКИ - 尺寸特征						
	LATI SIDES - SEITEN COTES - CANTOS РАЗМЕРЫ СТОРОН - 侧边	EN ISO 10545-2	± 0,3% MAX (± 1,0 mm MAX)		CONFORME COMPLYING		
	SPESSORE THICKNESS - DICKE EPAISSEUR - ESPESOR ТОЛЩИНА - 厚度	EN ISO 10545-2	± 5,0% MAX (± 0,5 mm MAX)		CONFORME COMPLYING		
	RETTILINEITÀ DEGLI SPIGOLI STRAIGHTNESS OF SIDES - GERADLINIGKEIT DER KANTEN RECTITUDE DES ARETES - RECTITUD DE LOS CANTOS КОСОУГОЛЬНОСТЬ - 边角平直度	EN ISO 10545-2	± 0,3% MAX (± 0,8 mm MAX)		CONFORME COMPLYING		
	ORTOGONALITÀ RECTANGULARITY - RECHTWINKLIGKEIT PERPENDICULARITÉ - ORTOGONALIDAD КРИВИЗНА СТОРОН - 直角度	EN ISO 10545-2	± 0,3% MAX (± 1,5 mm MAX)		CONFORME COMPLYING		
	PLANARITÀ SURFACE FLATNESS - EBENFLÄCHIGKEIT PLANEITE DE SURFACE - PLANEIDAD КРИВИЗНА ЛИЦЕВОЙ ПОВЕРХНОСТИ - 平整度	EN ISO 10545-2	± 0,4% MAX (± 1,8 mm MAX)		CONFORME COMPLYING		
	ASSORBIMENTO D'ACQUA WATER ABSORPTION - WASSERAUFNAHME ABSORPTION D'EAU - ABSORCIÓN DE AGUA ВОДОПОГЛОЩЕНИЕ - 吸水率	EN ISO 10545-3	≤ 0,5%		≤ 0,1%		
	RESISTENZA ALLA FLESSIONE FLEXION RESISTANCE - BIEGEFESTIGKEIT RESISTANCE A LA FLEXION - RESISTENCIA A LA FLEXIÓN ПРЕДЕЛ ПРОЧНОСТИ ПРИ ИЗГИБЕ - 抗弯强度	EN ISO 10545-4	S ≥ 700 N (< 7,5 mm) S ≥ 1.300 N (> 7,5 mm) R ≥ 35 N/mm².	±6 mm: S ≥ 1100 N R ≥ 45 N/mm² ±9 mm: S ≥ 2.400 N R ≥ 48 N/mm² ±20 mm: S ≥ 12.500 N R ≥ 48 N/mm²			
	RESISTENZA ALL'URTO IMPACT RESISTANCE - STOSSFESTIGKEIT RESISTANCE AUX CHOCES - RESISTENCIA A LOS GOLPES УДАРСТОЙКОСТЬ - 抗冲击强度	EN ISO 10545-5	VALORE DICHIARATO DECLARED VALUE		> 0,80		
	RESISTENZA ALL'ABRAZIONE ABRASION RESISTANCE - ABRIEFESTIGKEIT RESISTANCE A L'ABRASION - RESISTENCIA A LA ABRASIÓN СТОЙКОСТЬ К ИСТИРАНИЮ - 耐磨强度	EN ISO 10545-6	≤ 175 mm³		< 150 mm³		
	COEFFICIENTE DI DILATAZIONE TERMICA LINEARE COEFFICIENT OF LINEAR THERMAL-EXPANSION - LINEARER WÄRMEAUDEHNUNGSKOEFFIZIENT COEFFICIENT DE DILATATION THERMIQUE LINEAIRE - COEFICIENTE DE DILATACIÓN TÉRMICA LINEAL КОЭФФИЦИЕНТ ЛИНЕЙНОГО ТЕРМИЧЕСКОГО РАСШИРЕНИЯ - 线性热膨胀系数	EN ISO 10545-8	-		α=6,6x10 ⁻⁶ °C ⁻¹		
	RESISTENZA AGLI SBALZI TERMICI RESISTANCE TO THERMAL SHOCKS - BESTÄNDIGKEIT GEGEN TEMPERATURSCHWANKUNGEN RESISTANCE AUX CHOCES THERMIQUES - RESISTENCIA A LOS CHOQUES TÉRMICOS СТОЙКОСТЬ К ПЕРЕПАДАМ ТЕМПЕРАТУРЫ - 耐热突变性	EN ISO 10545-9	TEST SUPERATO SECONDO EN ISO 10545-1 PASS ACCORDING EN ISO 10545-1		NESSUN DANNO NO DAMAGE		
	RESISTENZA AL GELO FROST RESISTANCE - FROSTBESTÄNDIGKEIT RESISTANCE AU GEL - RESISTENCIA AL HIELO МОРОЗОСТОЙКОСТЬ - 耐冻性	EN ISO 10545-12	TEST SUPERATO SECONDO EN ISO 10545-1 PASS ACCORDING EN ISO 10545-1		NESSUN DANNO NO DAMAGE		
	RESISTENZA ALL'ATTACCO CHIMICO RESISTANCE TO CHEMICALS - CHEMIKALIENBESTÄNDIGKEIT RESISTANCE A L'ATTAQUE CHIMIQUE - RESISTENCIA QUÍMICA ХИМИЧЕСКАЯ СТОЙКОСТЬ - 耐化学品作用	EN ISO 10545-13	B MIN.		A LA HA		
	RESISTENZA ALLE MACCHIE RESISTANCE TO STAINS - FLECKENBESTÄNDIGKEIT RESISTANCE AUX TACHES - RESISTENCIA A LAS MANCHAS УСТОЙЧИВОСТЬ К ПЯТНООБРАЗОВАНИЮ - 防污性	EN ISO 10545-14	VALORE DICHIARATO DECLARED VALUE		5		
	CESSIONE DI PIOMBO E CADMIO LEAD AND CADMIUM DISCHARGE - ABGABE VON BLEI UND CADMIUM PERTE DE PLOMB ET CADMIUM - CESIÓN DE PLOMO Y CADMIO ВЫДЕЛЕНИЕ СВИНЦА И КАДМИЯ - 铅和镉的排放	EN ISO 10545-15	VALORE DICHIARATO DECLARED VALUE		< AL LIMITE DI RILEVAMENTO < THAN INSTRUMENT LIMIT		
				SP	NAT	RD 20mm	
			DM 236/89 BCRA	> 0,40	-	> 0,40	> 0,40
			ANSI A326.3	Wet and Dry	-	≥ 0,42	≥ 0,55
			AS 4586	-	-	P2	-
			DIN 51130	-	-	R10	R11
			DIN 51097	-	-	A	A+B+C
			UNE 41901	≥ CL1	-	CL2	-
			BS 7976 sl.96-4S	Wet and Dry	-	≥ 0,36	-
			BS 7976 sl.55-TRL	Wet and Dry	-	-	-
	SCIVOLOSITÀ SKID RESISTANCE - RUTSCHWERT GLISSANCE - ADHERENCIA СКОЛЬЗКОСТЬ - 防滑性						

Per i certificati specifici, contattare Mirage SpA - For specific certificates, please contact Mirage SpA - Für die speziellen Zertifikate wenden Sie sich bitte an Mirage SpA - Pour les certificats spécifiques, veuillez contacter Mirage SpA
Para los certificados específicos, contactar Mirage SpA - Для сертификатов обращайтесь в компанию Mirage SpA - 关于具体的证书, 请联系Mirage SpA公司



FLOOR: Peach **KO 02** 200x1200 / 8"x48" Chevron NAT RECT

KORU

The Koru collection **INSPIRED** by **FRUIT TREE WOODS**, characterised by a light grain, distinctive gnarls and compact fibres.

A perfect collection for floors and walls in residential and commercial settings.



FLOOR: Apple **KO 01** 200x1200 / 8"x48" NAT RECT



FLOOR: Apple **KO 01** 200x1200 / 8"x48" NAT RECT

COLORI

Colours | Farben | Couleurs | Colores | Цветов | 种颜色



Apple
KO 01



Peach
KO 02



Apricot
KO 03



Nut
KO 04



FLOOR: Nest Nut **KO 04** 210x420 / 8½"x17" NAT
WALL: Nut **KO 04** 200x1200 / 8"x48" NAT RECT



DECORI

Decors | Dekore | Decors | Decoros | Декоры | 装饰砖

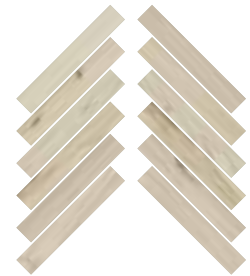

APPLE **KO 01**
DX-SX

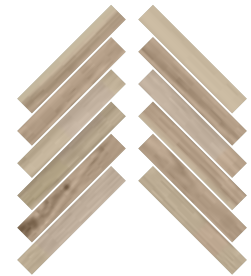

PEACH **KO 02**
DX-SX

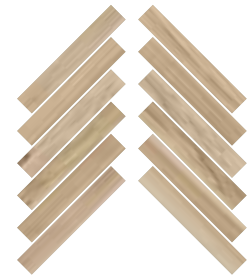

APRICOT **KO 03**
DX-SX



NUT **KO 04**
DX-SX

NEST:
Decoro su rete. | Mesh-backed decoration. | Dekor auf netz. | Décor sur filet. | Decoración en red. | Декор в сети. | 网板背帖装饰件

Pezzi per scatola
Pieces for box
Nest 3 dx | 3 sx

MY NOTES

.....

.....

.....

.....

Maggiori informazioni
More information



CARATTERISTICHE TECNICHE

Technical specifications | Technische Eigenschaften | Caractéristiques techniques | Características técnicas | Технические характеристики | 技术特征

STANDARD EN 14411 - G

	CARATTERISTICHE TECNICHE TECHNICAL DATA TECHNISCHE DATEN CARACTERISTIQUES TECHNIQUES CARACTERÍSTICAS TÉCNICAS ТЕХНИЧЕСКИЕ ХАРАКТЕРИСТИКИ 技术特征	NORMA STANDARD NORM NORME NORMA НОРМА 标准	VALORI PRESCRITTI DALLE NORME EN 14411 - G INTERNATIONAL STANDARDS EN 14411 - G INTERNATIONALE NORMWERTE EN 14411 - G VALEURS PREVUES PAR LES NORMES EN 14411 - G VALORES PREVISTOS POR LAS NORMAS EN 14411 - G ПРЕДУСМОТРЕННЫЕ СТАНДАРТOM EN 14411-G EN 14411 - G标准规定值	*VALORE MEDIO MIRAGE MIRAGE AVERAGE VALUE MIRAGE MITTELWERT VALEURS MOYEN MIRAGE VALOR MEDIO MIRAGE СРЕДНЕЕ ЗНАЧЕНИЕ MIRAGE MIRAGE平均值	
	CARATTERISTICHE DIMENSIONALI - SIZE CHARACTERISTICS - MASSEIGENSCHAFTEN DETERMINATION DES CARACTERISTIQUES DIMENSIONNELLES - CARACTERÍSTICAS DIMENSIONALES - РАЗМЕРНЫЕ ХАРАКТЕРИСТИКИ - 尺寸特征			NAT	
	LATI SIDES - SEITEN COTES - CANTOS РАЗМЕРЫ СТОРОН - 侧边	EN ISO 10545-2	± 0,3% MAX (± 1,0 mm MAX)	CONFORME COMPLYING	
	SPESSORE THICKNESS - DICKE EPAISSEUR - ESPESOR ТОЛЩИНА - 厚度	EN ISO 10545-2	± 5,0% MAX (± 0,5 mm MAX)	CONFORME COMPLYING	
	RETTILINEITÀ DEGLI SPIGOLI STRAIGHTNESS OF SIDES - GERADLINIGKEIT DER KANTEN RECTITUDE DES ARETES - RECTITUD DE LOS CANTOS КОСОУГОЛЬНОСТЬ - 边角平直度	EN ISO 10545-2	± 0,3% MAX (± 0,8 mm MAX)	CONFORME COMPLYING	
	ORTOGONALITÀ RECTANGULARITY - RECHTWINKLIGKEIT PERPENDICULARITÉ - ORTOGONALIDAD КРИВИЗНА СТОРОН - 直角度	EN ISO 10545-2	± 0,3% MAX (± 1,5 mm MAX)	CONFORME COMPLYING	
	PLANARITÀ SURFACE FLATNESS - EBENFLÄCHIGKEIT PLANEITE DE SURFACE - PLANEIDAD КРИВИЗНА ЛИЦЕВОЙ ПОВЕРХНОСТИ - 平整度	EN ISO 10545-2	± 0,4% MAX (± 1,8 mm MAX)	CONFORME COMPLYING	
	ASSORBIMENTO D'ACQUA WATER ABSORPTION - WASSERAUFNAHME ABSORPTION D'EAU - ABSORCIÓN DE AGUA ВОДОПОГЛОЩЕНИЕ - 吸水率	EN ISO 10545-3	≤ 0,5%	≤ 0,1%	
	RESISTENZA ALLA FLESSIONE FLEXION RESISTANCE - BIEGEFESTIGKEIT RESISTANCE A LA FLEXION - RESISTENCIA A LA FLEXIÓN ПРЕДЕЛ ПРОЧНОСТИ ПРИ ИЗГИБЕ - 抗弯强度	EN ISO 10545-4	S ≥ 700 N (< 7,5 mm) S ≥ 1.300 N (> 7,5 mm) R ≥ 35 N/mm².	≠ 9 mm: S ≥ 2.400 N R ≥ 48 N/mm²	
	RESISTENZA ALL'URTO IMPACT RESISTANCE - STOSSFESTIGKEIT RESISTANCE AUX CHOCES - RESISTENCIA A LOS GOLPES УДАРОСТОЙКОСТЬ - 抗冲击强度	EN ISO 10545-5	VALORE DICHIARATO DECLARED VALUE	> 0,80	
	RESISTENZA ALL'ABRAZIONE ABRASION RESISTANCE - ABRIEFESTIGKEIT RESISTANCE A L'ABRASION - RESISTENCIA A LA ABRASIÓN СТОЙКОСТЬ К ИСТИРАНИЮ - 耐磨强度	EN ISO 10545-6	≤ 175 mm³	< 150 mm³	
	COEFFICIENTE DI DILATAZIONE TERMICA LINEARE COEFFICIENT OF LINEAR THERMAL-EXPANSION - LINEARER WÄRMEAUDEHNUNGSKOEFFIZIENT COEFFICIENT DE DILATATION THERMIQUE LINEAIRE - COEFICIENTE DE DILATACIÓN TÉRMICA LINEAL КОЭФФИЦИЕНТ ЛИНЕЙНОГО ТЕРМИЧЕСКОГО РАСТЯЖЕНИЯ - 线性热膨胀系数	EN ISO 10545-8	-	α=6,6x10 ⁻⁶ °C ⁻¹	
	RESISTENZA AGLI SBALZI TERMICI RESISTANCE TO THERMAL SHOCKS - BESTÄNDIGKEIT GEGEN TEMPERATURSCHWANKUNGEN RESISTANCE AUX CHOCES THERMIQUES - RESISTENCIA A LOS CHOQUES TÉRMICOS СТОЙКОСТЬ К ПЕРЕПАДАМ ТЕМПЕРАТУРЫ - 耐热突变性	EN ISO 10545-9	TEST SUPERATO SECONDO EN ISO 10545-1 PASS ACCORDING EN ISO 10545-1	NESSUN DANNO NO DAMAGE	
	RESISTENZA AL GELO FROST RESISTANCE - FROSTBESTÄNDIGKEIT RESISTANCE AU GEL - RESISTENCIA AL HIELO МОРОЗОСТОЙКОСТЬ - 耐冻性	EN ISO 10545-12	TEST SUPERATO SECONDO EN ISO 10545-1 PASS ACCORDING EN ISO 10545-1	NESSUN DANNO NO DAMAGE	
	RESISTENZA ALL'ATTACCO CHIMICO RESISTANCE TO CHEMICALS - CHEMIKALIENBESTÄNDIGKEIT RESISTANCE A L'ATTAQUE CHIMIQUE - RESISTENCIA QUÍMICA ХИМИЧЕСКАЯ СТОЙКОСТЬ - 耐化学品作用	EN ISO 10545-13	UB MIN.	A LA HA	
	RESISTENZA ALLE MACCHIE RESISTANCE TO STAINS - FLECKENBESTÄNDIGKEIT RESISTANCE AUX TACHES - RESISTENCIA A LAS MANCHAS УСТОЙЧИВОСТЬ К ПЯТНООБРАЗОВАНИЮ - 防污性	EN ISO 10545-14	VALORE DICHIARATO DECLARED VALUE	6	
	CESSIONE DI PIOMBO E CADMIO LEAD AND CADMIUM DISCHARGE - ABGABE VON BLEI UND CADMIUM PERTE DE PLOMB ET CADMIUM - CESIÓN DE PLOMO Y CADMIO ВЫДЕЛЕНИЕ СВИНЦА И КАДМИЯ - 铅和镉的排放	EN ISO 10545-15	VALORE DICHIARATO DECLARED VALUE	< AL LIMITE DI RILEVAMENTO < THAN INSTRUMENT LIMIT	
	SCIVOLOSITÀ SKID RESISTANCE - RUTSCHWERT GLISSANCE - ADHERENCIA СКОЛЬЗКОСТЬ - 防滑性			NAT	
			DM 236/89 BCRA	> 0,40	> 0,40
			ANSI A326.3	Wet and Dry	≥ 0,42
			AS 4586	-	P2
			DIN 51130	-	R9
			DIN 51097	-	A
			UNE 41901	≥ CL1	CL1
			BS 7976 sl.96-4S	Wet and Dry	-
			BS 7976 sl.55-TRL	Wet and Dry	-

Per i certificati specifici, contattare Mirage SpA - For specific certificates, please contact Mirage SpA - Für die speziellen Zertifikate wenden Sie sich bitte an Mirage SpA - Pour les certificats spécifiques, veuillez contacter Mirage SpA
Para los certificados específicos, contactar Mirage SpA - Для сертификатов обращайтесь в компанию Mirage SpA - 关于具体的证书, 请联系Mirage SpA公司



WALL: Indio **LY 07** 600x1200 / 24"x48" SP RECT
 FLOOR: Afterglow **LY 05** 150x600 / 6"x24" SP RECT

LEMMY



Metals aged and scratched by the passage of time; colour contrasts between the original gleam of the metal and the opaque marks typical of oxidisation.

Lemmy captures the most intimate emotion of metal at its most natural and authentic to bring an elegant, unconventional touch.



Nimbus **LY 02** 1200x2780 / 48"x110" SP RECT



FLOOR: Palladium LY 01 600x1200 / 24"x48" SP RECT

COLORI

Colours | Farben | Couleurs | Colores | Цветов | 种颜色





FLOOR: Nimbus **LY 02** 600x600 / 24"x24" SP RECT
WALL: Pumpkin **LY 08** 600x1200 / 24"x48" SP RECT
SHOWER: Nimbus **LY 02** 1200x2780 / 48"x110" SP RECT + BATHMOOD Appeal **LY 04** SP

COLORI

Colours | Farben | Couleurs | Colores | Цветов | 种颜色

PALLADIUM LY 01



Formati Nominali Nominal Sizes	Superficie Finish	Spessore mm Thickness mm
150x600 / 6"x24"	SP RECT	9
300x600 / 12"x24"	SP RECT	9
600x600 / 24"x24"	SP RECT	9
600x1200 / 24"x48"	SP RECT	9
800x800 / 31½"x31½"	SP RECT	9
1200x1200 / 48"x48"	SP RECT	9
1200x1200 / 48"x48"	SP RECT	6
1200x2780 / 48"x110"	SP RECT	6

Stucchi consigliati Recommended grouts		
KERAKOLL	03	
MAPEI	111 Grigio Argento	
LATICRETE	88 Silver Shadow	

VENOM LY 04



Formati Nominali Nominal Sizes	Superficie Finish	Spessore mm Thickness mm
150x600 / 6"x24"	SP RECT	9
300x600 / 12"x24"	SP RECT	9
600x600 / 24"x24"	SP RECT	9
600x1200 / 24"x48"	SP RECT	9
800x800 / 31½"x31½"	SP RECT	9
1200x1200 / 48"x48"	SP RECT	9
1200x1200 / 48"x48"	SP RECT	6
1200x2780 / 48"x110"	SP RECT	6
800x800 / 31½"x31½"	ST RECT	20

Stucchi consigliati Recommended grouts		
KERAKOLL	11	
MAPEI	114 Antracite	
LATICRETE	45 Raven	

NIMBUS LY 02



Formati Nominali Nominal Sizes	Superficie Finish	Spessore mm Thickness mm
150x600 / 6"x24"	SP RECT	9
300x600 / 12"x24"	SP RECT	9
600x600 / 24"x24"	SP RECT	9
600x1200 / 24"x48"	SP RECT	9
800x800 / 31½"x31½"	SP RECT	9
1200x1200 / 48"x48"	SP RECT	9
1200x1200 / 48"x48"	SP RECT	6
1200x2780 / 48"x110"	SP RECT	6
800x800 / 31½"x31½"	ST RECT	20

Stucchi consigliati Recommended grouts		
KERAKOLL	05	
MAPEI	110 Manhattan	
LATICRETE	89 Smoke Grey	

AFTERGLOW LY 05



Formati Nominali Nominal Sizes	Superficie Finish	Spessore mm Thickness mm
150x600 / 6"x24"	SP RECT	9
300x600 / 12"x24"	SP RECT	9
600x600 / 24"x24"	SP RECT	9
600x1200 / 24"x48"	SP RECT	9
800x800 / 31½"x31½"	SP RECT	9
1200x1200 / 48"x48"	SP RECT	9
1200x1200 / 48"x48"	SP RECT	6
1200x2780 / 48"x110"	SP RECT	6

Stucchi consigliati Recommended grouts		
KERAKOLL	20	
MAPEI	110 Manhattan	
LATICRETE	89 Smoke Grey	

EXCALIBUR LY 03



Formati Nominali Nominal Sizes	Superficie Finish	Spessore mm Thickness mm
150x600 / 6"x24"	SP RECT	9
300x600 / 12"x24"	SP RECT	9
600x600 / 24"x24"	SP RECT	9
600x1200 / 24"x48"	SP RECT	9
800x800 / 31½"x31½"	SP RECT	9
1200x1200 / 48"x48"	SP RECT	9
1200x1200 / 48"x48"	SP RECT	6
1200x2780 / 48"x110"	SP RECT	6
800x800 / 31½"x31½"	ST RECT	20

Stucchi consigliati Recommended grouts		
KERAKOLL	05	
MAPEI	112 Grigio Medio	
LATICRETE	78 Sterling Silver	

VIRIDIUM LY 06



Formati Nominali Nominal Sizes	Superficie Finish	Spessore mm Thickness mm
150x600 / 6"x24"	SP RECT	9
300x600 / 12"x24"	SP RECT	9
600x600 / 24"x24"	SP RECT	9
600x1200 / 24"x48"	SP RECT	9

Stucchi consigliati Recommended grouts		
KERAKOLL	19	
MAPEI	114 Antracite	
LATICRETE	45 Raven	

COLORI

Colours | Farben | Couleurs | Colores | Цветов | 种颜色

INDIO LY 07



	Formati Nominali Nominal Sizes		Superficie Finish		Spessore mm Thickness mm
	150x600 / 6"x24"		SP RECT		9
	300x600 / 12"x24"		SP RECT		9
	600x600 / 24"x24"		SP RECT		9
	600x1200 / 24"x48"		SP RECT		9
	Stucchi consigliati Recommended grouts				
	KERAKOLL	15			
	MAPEI	114 Antracite			
	LATICRETE	45 Raven			



PUMPKIN LY 08



	Formati Nominali Nominal Sizes		Superficie Finish		Spessore mm Thickness mm
	150x600 / 6"x24"		SP RECT		9
	300x600 / 12"x24"		SP RECT		9
	600x600 / 24"x24"		SP RECT		9
	600x1200 / 24"x48"		SP RECT		9
	Stucchi consigliati Recommended grouts				
	KERAKOLL	31			
	MAPEI	112 Grigio Medio			
	LATICRETE	78 Sterling Silver			



KING LY 09



	Formati Nominali Nominal Sizes		Superficie Finish		Spessore mm Thickness mm
	150x600 / 6"x24"		SP RECT		9
	300x600 / 12"x24"		SP RECT		9
	600x600 / 24"x24"		SP RECT		9
	600x1200 / 24"x48"		SP RECT		9
	800x800 / 31½"x31½"		SP RECT		9
	1200x1200 / 48"x48"		SP RECT		9
	800x800 / 31½"x31½"		ST RECT		20
	Stucchi consigliati Recommended grouts				
	KERAKOLL	08			
	MAPEI	114 Antracite			
	LATICRETE	45 Raven			



WALL: Bianco MD 01 300x450 / 12"x18" MELLOW
FLOOR: Nimbus LY 02 800x800 / 31½"x31½" SP RECT

RIASSUNTIVO FORMATI ED IMBALLI

Summary of sizes and packaging | Übersicht über Formate und Verpackungen | Récapitulatif formats et emballages
Sinóptico de formatos y embalajes | Краткая информация о форматах и упаковках | 规格和包装概述

		± 9 mm					
Formati Nominali Nominal Sizes		150x600 6"x24"	300x600 12"x24"	600x600 24"x24"	600x1200 24"x48"	800x800 31½"x31½"	1200x1200 48"x48"
Tutti i formati sono rettificati. All sizes are rectified.							
Superficie Finish		SP	SP	SP	SP	SP	SP
	PALLADIUM LY 01	V2	■	■	■	■	■
	NIMBUS LY 02	V2	■	■	■	■	■
	EXCALIBUR LY 03	V2	■	■	■	■	■
	VENOM LY 04	V2	■	■	■	■	■
	AFTERGLOW LY 05	V2	■	■	■	■	■
	VIRIDIUM LY 06	V2	■	■	■	-	-
	INDIO LY 07	V2	■	■	■	-	-
	PUMPKIN LY 08	V2	■	■	■	-	-
	KING LY 09	V2	■	■	■	■	■
	Peso lordo per scatola Gross weight per box	26,92	25,78	22,26	29,40	27,36	61,56
	Pezzi per scatola Pieces for box	14	7	3	2	2	2
	mq. scatola sqm. box	1,26	1,26	1,08	1,44	1,28	2,88
	Scatole / Full pallet boxes / Full pallet	40	40	40	35	48	20
	mq. pallet sqm. pallet	50,40	50,40	43,20	50,40	61,44	57,60

TUTTI I FORMATI IN 9 MM NAT SONO REALIZZATI CON LA TECNOLOGIA PERFORMA (NAT R10 A+B).
All 9 mm NAT sizes are produced with PERFORMA technology (NAT R10 A+B).

		± 6 mm		± 20 mm	
Formati Nominali Nominal Sizes		1200x1200 48"x48"	1200x2780 48"x110"	800x800 31½"x31½"	
Tutti i formati sono rettificati. All sizes are rectified.					
Superficie Finish		SP		ST	
	PALLADIUM LY 01	V2	■	■	-
	NIMBUS LY 02	V2	■	■	■
	EXCALIBUR LY 03	V2	■	■	■
	VENOM LY 04	V2	■	■	■
	AFTERGLOW LY 05	V2	■	■	-
	VIRIDIUM LY 06	V2	-	-	-
	INDIO LY 07	V2	-	-	-
	PUMPKIN LY 08	V2	-	-	-
	KING LY 09	V2	-	-	■
	Peso lordo per scatola Gross weight per box	-		28,50	
	Pezzi per scatola Pieces for box	2		1	
	mq. scatola sqm. box	2,88		0,64	
	Scatole / Full pallet boxes / Full pallet	20		42	
	mq. pallet sqm. pallet	57,60		26,88	

Please refer to page 588

Per tutti i grandi formati è possibile prevedere, su richiesta, e con un lotto minimo l'applicazione di una stuoia in fibra di vetro.
For big sizes, a fibreglass mat can be applied on request, with a minimum production batch.

ACCORDIMENTI SPECIFICI PER L'APPLICAZIONE DELLE GRANDI LASTRE IN 6 MM DI SPESSORE: p. 582 | Precautions for 6mm big slabs applications: page 582 | spezifische Anweisungen zur Nutzung der Grossformate in 6mm: seite 582 | Precauciones específicas para la aplicación de las grandes placas en 6 mm de espesor: page 582 | Precautions spécifiques pour la pose des grandes plaques en 6mm d'épaisseur: página 582 | специальные предосторожности для укладки больших плит толщиной 6 мм : страница 582

PEZZI SPECIALI

Special pieces | Sonderstücke | Pièces spéciales | Piezas especiales | специальные изделия | 特殊件

		Battiscopa*		Gradino A*		Gradino G*		Grad. B ang.		Gradino B		
Pezzi speciali Special pieces		72x600 27/8"x24"	72x800 27/8"x31½"	300x600 12"x24"	330x800 13/5"x31½"	330x1200 13/5"x48"	300x600 12"x24"	330x800 13/5"x31½"	330x330 13/5"x13/5"	330x600 13/5"x24"	330x800 13/5"x31½"	330x1200 13/5"x48"
Superficie Finish		SP	SP	SP	SP	SP	SP	SP	SP	SP	SP	SP
	PALLADIUM LY 01	■	■	■	■	■	■	■	■	■	■	■
	NIMBUS LY 02	■	■	■	■	■	■	■	■	■	■	■
	EXCALIBUR LY 03	■	■	■	■	■	■	■	■	■	■	■
	VENOM LY 04	■	■	■	■	■	■	■	■	■	■	■
	AFTERGLOW LY 05	■	■	■	■	■	■	■	■	■	■	■
	VIRIDIUM LY 06	■	-	■	-	■	■	-	■	■	-	■
	INDIO LY 07	■	-	■	-	■	■	-	■	■	-	■
	PUMPKIN LY 08	■	-	■	-	■	■	-	■	■	-	■
	KING LY 09	■	■	■	■	■	■	■	■	■	■	■
	Pezzi per scatola Pieces for box	10	10	7	7	4	7	7	4	4	4	2

* Finitura a becco di civetta | One-round edge shaping | Ausführung mit Eckabrundung | Façonage à bord rond | Acabado canto romo | Плитка с завалом | 鹰嘴边缘处理

MY NOTES

.....

.....

.....

.....

.....

Maggiori informazioni
More information



ST: Strutturata | Structured | Strukturiert | Structuré | Estructurado | Труктурированный | 结构
SP: Spazzolata

DECORI

Decors | Dekore | Decors | Decoros | Декоры | 装饰砖

Mosaico 36T SP
300x300 / 12"x12"
Tessere 48x48 / 2"x2"



PALLADIUM LY 01 NIMBUS LY 02 EXCALIBUR LY 03



VENOM LY 04 AFTERGLOW LY 05 VIRIDIUM LY 06

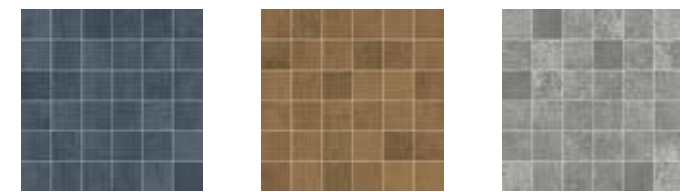

INDIO LY 07 PUMPKIN LY 08 KING LY 09

Foliage SP
323x305 / 12¾"x12"



PALLADIUM LY 01 NIMBUS LY 02 EXCALIBUR LY 03 VENOM LY 04 AFTERGLOW LY 05



VIRIDIUM LY 06 INDIO LY 07 PUMPKIN LY 08 KING LY 09

MOSAICO 36T, FOLIAGE, PLUME:
Decoro su rete | Mesh-backed decoration | Dekor auf netz | Décor sur filet | Decoración en red | Декор в сети | 网板背帖装饰件

I DECORATI 800x800x20 mm

800x800x20 mm decorated tiles | Die dekorierten Fliesen 800x800x20 mm | Les décorés 800x800x20 mm
Azulejos decorados 800x800x20 mm | Декоры 800x800x20 mm | 装饰砖 800x800x20 mm

NORDIC (COLD) ST 20 MM



800x800x20 / 31½"x31½"x¾"

2 grafiche
2 graphics

NORDIC (WARM) ST 20 MM

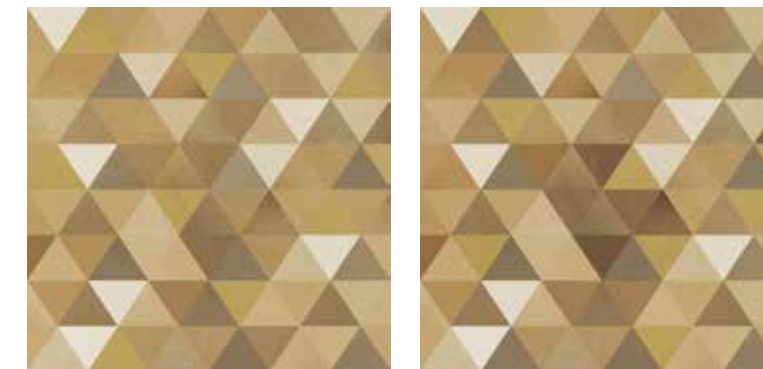

800x800x20 / 31½"x31½"x¾"

2 grafiche
2 graphics

Pezzi per scatola
Pieces for box

Mosaico 36T	6
Foliage	10
Plume	6
Nordic	1



INDOOR FLOOR: Excalibur **LY 03** 800x800 / 31½"x31½" SP RECT
 OUTDOOR FLOOR: Nordic Cold Decoration 800x800 / 31½"x31½" SP RECT EVO_2/E"

CARATTERISTICHE TECNICHE

Technical specifications | Technische Eigenschaften | Caractéristiques techniques | Características técnicas | Технические характеристики | 技术特征

STANDARD EN 14411 - G

	CARATTERISTICHE TECNICHE TECHNICAL DATA TECHNISCHE DATEN CARACTERISTIQUES TECHNIQUES CARACTERÍSTICAS TÉCNICAS ТЕХНИЧЕСКИЕ ХАРАКТЕРИСТИКИ 技术特征	NORMA STANDARD NORM NORME NORMA ЗНАЧЕНИЯ 标准	VALORI PRESCRITTI DALLE NORME EN 14411 - G INTERNATIONAL STANDARDS EN 14411 - G INTERNATIONALE NORMWERTE EN 14411 - G VALEURS PREVUES PAR LES NORMES EN 14411 - G VALORES PREVISTOS POR LAS NORMAS EN 14411 - G ПРЕДУСМОТРЕННЫЕ СТАНДАРТOM EN 14411-G EN 14411 - G标准规定值	*VALORE MEDIO MIRAGE MIRAGE AVERAGE VALUE MIRAGE MITTELWERT VALEURS MOYEN MIRAGE VALOR MEDIO MIRAGE СРЕДНЕЕ ЗНАЧЕНИЕ MIRAGE MIRAGE平均值
	CARATTERISTICHE DIMENSIONALI - SIZE CHARACTERISTICS - MASSEIGENSCHAFTEN DETERMINATION DES CARACTERISTIQUES DIMENSIONNELLES - CARACTERÍSTICAS DIMENSIONALES - РАЗМЕРНЫЕ ХАРАКТЕРИСТИКИ - 尺寸特征			
	LATI SIDES - SEITEN COTES - CANTOS РАЗМЕРЫ СТОРОН - 侧边	EN ISO 10545-2	± 0,3% MAX (± 1,0 mm MAX)	CONFORME COMPLYING
	SPESSORE THICKNESS - DICKE EPAISSEUR - ESPESOR ТОЛЩИНА - 厚度	EN ISO 10545-2	± 5,0% MAX (± 0,5 mm MAX)	CONFORME COMPLYING
	RETTILINEITÀ DEGLI SPIGOLI STRAIGHTNESS OF SIDES - GERADLINIGKEIT DER KANTEN RECTITUDE DES ARETES - RECTITUD DE LOS CANTOS КОСОУГОЛЬНОСТЬ - 边角平直度	EN ISO 10545-2	± 0,3% MAX (± 0,8 mm MAX)	CONFORME COMPLYING
	ORTOGONALITÀ RECTANGULARITY - RECHTWINKLIGKEIT PERPENDICULARITÉ - ORTOGONALIDAD КРИВИЗНА СТОРОН - 直角度	EN ISO 10545-2	± 0,3% MAX (± 1,5 mm MAX)	CONFORME COMPLYING
	PLANARITÀ SURFACE FLATNESS - EBENFLÄCHIGKEIT PLANEITE DE SURFACE - PLANEIDAD КРИВИЗНА ЛИЦЕВОЙ ПОВЕРХНОСТИ - 平整度	EN ISO 10545-2	± 0,4% MAX (± 1,8 mm MAX)	CONFORME COMPLYING
	ASSORBIMENTO D'ACQUA WATER ABSORPTION - WASSERAUFNAHME ABSORPTION D'EAU - ABSORCIÓN DE AGUA ВОДОПОГЛОЩЕНИЕ - 吸水率	EN ISO 10545-3	≤ 0,5%	≤ 0,1%
	RESISTENZA ALLA FLESSIONE FLEXION RESISTANCE - BIEGEFESTIGKEIT RESISTANCE A LA FLEXION - RESISTENCIA A LA FLEXIÓN ПРЕДЕЛ ПРОЧНОСТИ ПРИ ИЗГИБЕ - 抗弯强度	EN ISO 10545-4	S ≥ 700 N (< 7,5 mm) S ≥ 1.300 N (> 7,5 mm) R ≥ 35 N/mm².	≠6 mm: S ≥ 1100 N R ≥ 45 N/mm² ≠9 mm: S ≥ 2.400 N R ≥ 48 N/mm² ≠20 mm: S ≥ 12.500 N R ≥ 48 N/mm²
	RESISTENZA ALL'URTO IMPACT RESISTANCE - STOSSFESTIGKEIT RESISTANCE AUX CHOCES - RESISTENCIA A LOS GOLPES УДАРСТОЙКОСТЬ - 抗冲击强度	EN ISO 10545-5	VALORE DICHIARATO DECLARED VALUE	> 0,80
	RESISTENZA ALL'ABRAZIONE ABRASION RESISTANCE - ABRIEBFESTIGKEIT RESISTANCE A L'ABRASION - RESISTENCIA A LA ABRASIÓN СТОЙКОСТЬ К ИСТИРАНИЮ - 耐磨强度	EN ISO 10545-6	≤ 175 mm³	< 150 mm³
	COEFFICIENTE DI DILATAZIONE TERMICA LINEARE COEFFICIENT OF LINEAR THERMAL-EXPANSION - LINEARER WÄRMEAUDEHNUNGSKOEFFIZIENT COEFFICIENT DE DILATATION THERMIQUE LINEAIRE - COEFICIENTE DE DILATACIÓN TÉRMICA LINEAL КОЭФФИЦИЕНТ ЛИНЕЙНОГО ТЕРМИЧЕСКОГО РАСШИРЕНИЯ - 线性热膨胀系数	EN ISO 10545-8	-	α=6,6x10 ⁻⁶ °C ⁻¹
	RESISTENZA AGLI SBALZI TERMICI RESISTANCE TO THERMAL SHOCKS - BESTÄNDIGKEIT GEGEN TEMPERATURSCHWANKUNGEN RESISTANCE AUX CHOCES THERMIQUES - RESISTENCIA A LOS CHOQUES TÉRMICOS СТОЙКОСТЬ К ПЕРЕПАДАМ ТЕМПЕРАТУРЫ - 耐热突变性	EN ISO 10545-9	TEST SUPERATO SECONDO EN ISO 10545-1 PASS ACCORDING EN ISO 10545-1	NESSUN DANNO NO DAMAGE
	RESISTENZA AL GELO FROST RESISTANCE - FROSTBESTÄNDIGKEIT RESISTANCE AU GEL - RESISTENCIA AL HIELO МОРОЗОСТОЙКОСТЬ - 耐冻性	EN ISO 10545-12	TEST SUPERATO SECONDO EN ISO 10545-1 PASS ACCORDING EN ISO 10545-1	NESSUN DANNO NO DAMAGE
	RESISTENZA ALL'ATTACCO CHIMICO RESISTANCE TO CHEMICALS - CHEMIKALIENBESTÄNDIGKEIT RESISTANCE A L'ATTAQUE CHIMIQUE - RESISTENCIA QUÍMICA ХИМИЧЕСКАЯ СТОЙКОСТЬ - 耐化学品作用	EN ISO 10545-13	UB MIN.	A LA HA
	RESISTENZA ALLE MACCHIE RESISTANCE TO STAINS - FLECKENBESTÄNDIGKEIT RESISTANCE AUX TACHES - RESISTENCIA A LAS MANCHAS УСТОЙЧИВОСТЬ К ПЯТНООБРАЗОВАНИЮ - 防污性	EN ISO 10545-14	VALORE DICHIARATO DECLARED VALUE	5
	CESSIONE DI PIOMBO E CADMIO LEAD AND CADMIUM DISCHARGE - ABGABE VON BLEI UND CADMIUM PERTE DE PLOMB ET CADMIUM - CESIÓN DE PLOMO Y CADMIO ВЫДЕЛЕНИЕ СВИНЦА И КАДМИЯ - 铅和镉的排放	EN ISO 10545-15	VALORE DICHIARATO DECLARED VALUE	< AL LIMITE DI RILEVAMENTO < THAN INSTRUMENT LIMIT
	SCIVOLOSITÀ SKID RESISTANCE - RUTSCHWERT GLISSANCE - ADHERENCIA СКОЛЬЗКОСТЬ - 防滑性			SP ST 20mm
	DM 236/89 BCRA		> 0,40	> 0,40 > 0,40
	ANSI A326.3		Wet and Dry	≥ 0,42 ≥ 0,55
	AS 4586		-	P2 P5
	DIN 51130		-	R9 R11
	DIN 51097		-	- A+B+C
	UNE 41901		≥ CL1	CL1 CL3
	BS 7976 sl.96-4S		Wet and Dry	- ≥ 0,36
	BS 7976 sl.55-TRL		Wet and Dry	- ≥ 0,36

Per i certificati specifici, contattare Mirage SpA - For specific certificates, please contact Mirage SpA - Für die speziellen Zertifikate wenden Sie sich bitte an Mirage SpA - Pour les certificats spécifiques, veuillez contacter Mirage SpA
 Para los certificados específicos, contactar Mirage SpA - Для сертификатов обращайтесь в компанию Mirage SpA - 关于具体的证书, 请联系Mirage SpA公司



WALL: Terracotta **MD 03** DAWN 300x450 / 12"x18" NOT RECT
 FLOOR: MÓTLEY Monterey **MT 02** 600x600 / 24"x24" ST RECT EVO_2/E* 20 mm

MAND

A project of porcelain stoneware wall tiles suitable for both indoor and outdoor use inspired by the world of handcrafted techniques.

Three neutral colours, ranging from warm white to terracotta up to light grey, give the tiles a simplicity that allows for very different styles.



WALL: Grigio **MD 02** MUSE 300x450 / 12"x18" NOT RECT
 NORR Farge **RR 05** 600x1200 / 24"x48" NAT RECT
 FLOOR: NORR Farge **RR 05** 800x800 / 31½"x31½" SP RECT



WALL: Bianco **MD 01** NORTH 300x450 / 12"x18" NOT RECT
 NORR Grå **RR 02** 600x1200 / 24"x48" NAT RECT
 FLOOR: OUDH Jinkoh **OU 03** 200x1200 / 8"x48" GP RECT

COLORI

Colours | Farben | Couleurs | Colores | Цветов | 种颜色

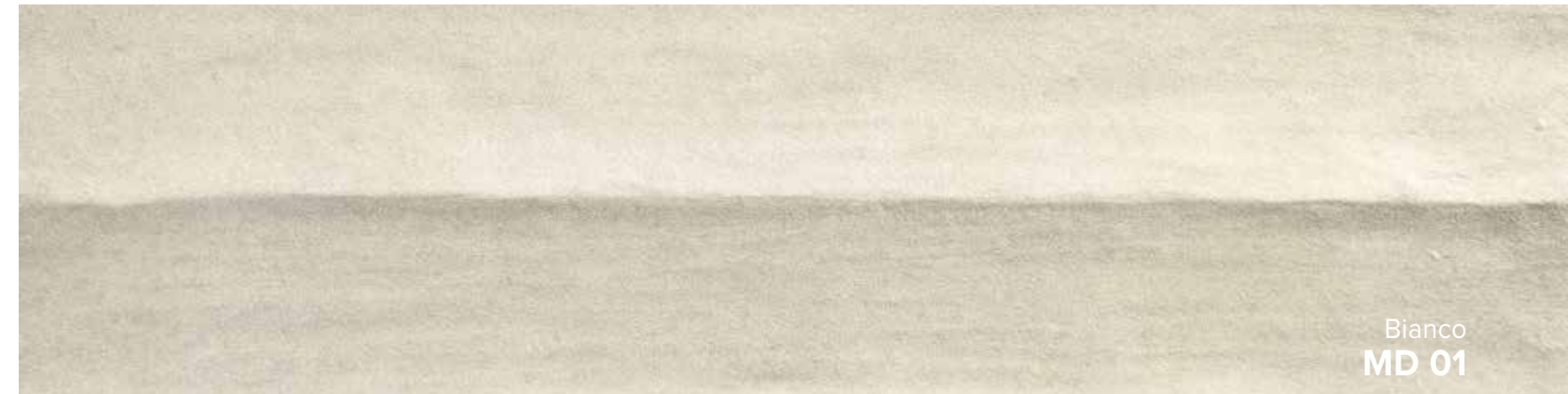

Bianco
MD 01



Grigio
MD 02



Terracotta
MD 03



WALL: Terracotta **MD 03** DAWN 300x450 / 12"x18" NOT RECT
FLOOR: VICEVERSA Veneziano 800x800 / 31½"x31½" SP RECT





WALL: Terracotta **MD 03** ARMOR 300x450 / 12"x18" NOT RECT
 FLOOR: OUDH Jinkoh **OU 03** 200x1200 / 12"x48" SP RECT

COLORI

Colours | Farben | Couleurs | Colores | Цветов | 种颜色

BIANCO MD 01



Formati Nominali Nominal Sizes		Superficie Finish	Spessore mm Thickness mm
300x450 / 12"x18"		MELLOW	-
300x450 / 12"x18"		ARMOR	-
300x450 / 12"x18"		NORTH	-
300x450 / 12"x18"		DAWN	-
300x450 / 12"x18"		MUSE	-

Stucchi consigliati Recommended grouts		
KERAKOLL	20	
MAPEI	111 Grigio Argento	
LATICRETE	85 Almond	

GRIGIO MD 02



Formati Nominali Nominal Sizes		Superficie Finish	Spessore mm Thickness mm
300x450 / 12"x18"		MELLOW	-
300x450 / 12"x18"		ARMOR	-
300x450 / 12"x18"		NORTH	-
300x450 / 12"x18"		DAWN	-
300x450 / 12"x18"		MUSE	-

Stucchi consigliati Recommended grouts		
KERAKOLL	06	
MAPEI	112 Grigio Medio	
LATICRETE	78 Sterling Silver	

TERRACOTTA MD 03

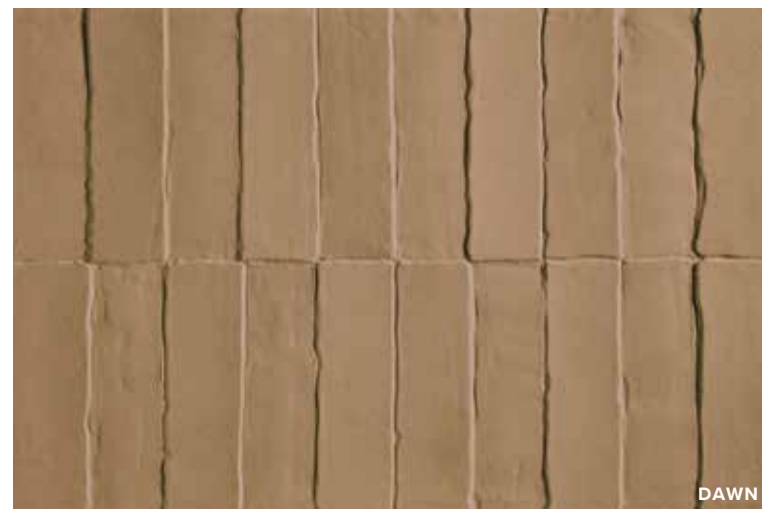

Formati Nominali Nominal Sizes		Superficie Finish	Spessore mm Thickness mm
300x450 / 12"x18"		MELLOW	-
300x450 / 12"x18"		ARMOR	-
300x450 / 12"x18"		NORTH	-
300x450 / 12"x18"		DAWN	-
300x450 / 12"x18"		MUSE	-

Stucchi consigliati Recommended grouts		
KERAKOLL	31	
MAPEI	133	
LATICRETE	40 Latte	

RIASSUNTIVO FORMATI ED IMBALLI

Summary of sizes and packaging | Übersicht über Formate und Verpackungen | Récapitulatif formats et emballages
Sinóptico de formatos y embalajes | Краткая информация о форматах и упаковках | 规格和包装概述

Formati Nominali Nominal Sizes	300x450 12"x18"				
	MELLOW	ARMOR	NORTH	DAWN	MUSE
BIANCO MD 01	■	■	■	■	■
GRIGIO MD 02	■	■	■	■	■
TERRACOTTA MD 03	■	■	■	■	■
Pezzi per scatola Pieces for box	6	6	6	6	6

PRODOTTO ADATTO ESCLUSIVAMENTE PER L'APPLICAZIONE A RIVESTIMENTO. | Ausschließlich für die Anwendung als Wandverkleidung geeignetes Produkt. | Produit adapté exclusivement à une application en revêtement. | Producto solo apto para aplicación como revestimiento. | Продукт, подходящий для применения в качестве настенной облицовки | 产品只适用于墙体应用。

MELLOW



ARMOR



NORTH



DAWN

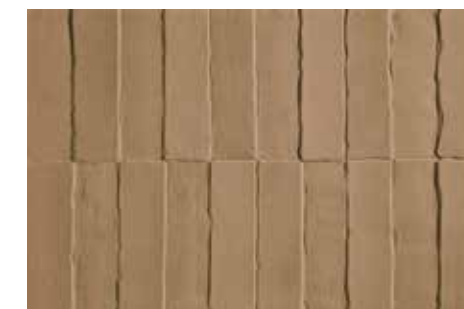

MUSE



MY NOTES

.....

.....

.....

.....

.....

Maggiori informazioni
More information





WALL: Terracotta **MD 03** MELLOW 300x450 / 12"x18" NOT RECT
 FLOOR: ELYSIAN Mediterranea **EY 01** 800x800 / 31½"x31½" ST RECT EVO_2/E" ± 20 mm

CARATTERISTICHE TECNICHE

Technical specifications | Technische Eigenschaften | Caractéristiques techniques | Características técnicas | Технические характеристики | 技术特征

STANDARD EN 14411 - G

	CARATTERISTICHE TECNICHE TECHNICAL DATA TECHNISCHE DATEN CARACTERISTIQUES TECHNIQUES CARACTERÍSTICAS TÉCNICAS ТЕХНИЧЕСКИЕ ХАРАКТЕРИСТИКИ 技术特征	NORMA STANDARD NORM NORME NORMA ЗНАЧЕНИЯ 标准	VALORI PRESCRITTI DALLE NORME EN 14411 - G INTERNATIONAL STANDARDS EN 14411 - G INTERNATIONALE NORMWERTE EN 14411 - G VALEURS PREVUES PAR LES NORMES EN 14411 - G VALORES PREVISTOS POR LAS NORMAS EN 14411 - G ПРЕДУСМОТРЕННЫЕ СТАНДАРТОВ EN 14411-G EN 14411 - G标准规定值	*VALORE MEDIO MIRAGE MIRAGE AVERAGE VALUE MIRAGE MITTELWERT VALEURS MOYEN MIRAGE VALOR MEDIO MIRAGE СРЕДНЕЕ ЗНАЧЕНИЕ MIRAGE MIRAGE平均值
	CARATTERISTICHE DIMENSIONALI - SIZE CHARACTERISTICS - MASSEIGENSCHAFTEN DETERMINATION DES CARACTERISTIQUES DIMENSIONNELLES - CARACTERÍSTICAS DIMENSIONALES - РАЗМЕРНЫЕ ХАРАКТЕРИСТИКИ - 尺寸特征			
	LATI SIDES - SEITEN COTES - CANTOS РАЗМЕРЫ СТОРОН - 側邊	EN ISO 10545-2	± 0,6% MAX (± 2,0 mm MAX)	CONFORME COMPLYING
	SPESSORE THICKNESS - DICKE EPAISSEUR - ESPESOR ТОЛЩИНА - 厚度	EN ISO 10545-2	± 5,0% MAX (± 0,5 mm MAX)	CONFORME COMPLYING
	RETTILINEITÀ DEGLI SPIGOLI STRAIGHTNESS OF SIDES - GERADLINIGKEIT DER KANTEN RECTITUDE DES ARETES - RECTITUD DE LOS CANTOS КОСОУГОЛЬНОСТЬ - 边角平直度	EN ISO 10545-2	± 0,5% MAX (± 1,5 mm MAX)	CONFORME COMPLYING
	ORTOGONALITÀ RECTANGULARITY - RECHTWINKLIGKEIT PERPENDICULARITÉ - ORTOGONALIDAD КРИВИЗНА СТОРОН - 直角度	EN ISO 10545-2	± 0,5% MAX (± 2,0 mm MAX)	CONFORME COMPLYING
	PLANARITÀ SURFACE FLATNESS - EBENFLÄCHIGKEIT PLANEITE DE SURFACE - PLANEIDAD КРИВИЗНА ЛИЦЕВОЙ ПОВЕРХНОСТИ - 平整度	EN ISO 10545-2	± 0,5% MAX (± 2,0 mm MAX)	CONFORME COMPLYING
	ASSORBIMENTO D'ACQUA WATER ABSORPTION - WASSERAUFNAHME ABSORPTION D'EAU - ABSORCIÓN DE AGUA ВОДОПОГЛОЩЕНИЕ - 吸水率	EN ISO 10545-3	≤ 0,5%	CONFORME COMPLYING
	RESISTENZA ALLA FLESSIONE FLEXION RESISTANCE - BIEGEFESTIGKEIT RESISTANCE A LA FLEXION - RESISTENCIA A LA FLEXIÓN ПРЕДЕЛ ПРОЧНОСТИ ПРИ ИЗГИБЕ - 抗弯强度	EN ISO 10545-4	S ≥ 700 N (< 7,5 mm) S ≥ 1.300 N (> 7,5 mm) R ≥ 35 N/mm².	≧ 9 mm: S ≥ 2.400 N R ≥ 48 N/mm²
	RESISTENZA ALL'URTO IMPACT RESISTANCE - STOSSFESTIGKEIT RESISTANCE AUX CHOCS - RESISTENCIA A LOS GOLPES УДАРСТОЙКОСТЬ - 抗冲击强度	EN ISO 10545-5	VALORE DICHIARATO DECLARED VALUE	> 0,80
	RESISTENZA ALL'ABRASIONE SUPERFICIALE SURFACE ABRASION RESISTANCE - ABRIEFESTIGKEIT DER OBERFLÄCHE RESISTANCE À L'ABRASION SUPERFICIELLE - RESISTENCIA A LA ABRASIÓN SUPERFICIAL ХИМИЧЕСКАЯ СТОЙКОСТЬ - 耐表面磨损	EN ISO 10545-7	≤ 175 mm³	CONFORME COMPLYING
	COEFFICIENTE DI DILATAZIONE TERMICA LINEARE COEFFICIENT OF LINEAR THERMAL-EXPANSION - LINEARER WÄRMEAUSSDEHNUNGSKOEFFIZIENT COEFFICIENT DE DILATATION THERMIQUE LINEAIRE - COEFICIENTE DE DILATACIÓN TÉRMICA LINEAL КОЭФФИЦИЕНТ ЛИНЕЙНОГО ТЕРМИЧЕСКОГО РАСШИРЕНИЯ - 线性热膨胀系数	EN ISO 10545-8	-	α=6,6x10 ⁻⁶ °C ⁻¹
	RESISTENZA AGLI SBALZI TERMICI RESISTANCE TO THERMAL SHOCKS - BESTÄNDIGKEIT GEGEN TEMPERATURSCHWANKUNGEN RESISTANCE AUX CHOCS THERMIQUES - RESISTENCIA A LOS CHOQUES TÉRMICOS СТОЙКОСТЬ К ПЕРЕПАДАМ ТЕМПЕРАТУРЫ - 耐热突变性	EN ISO 10545-9	TEST SUPERATO SECONDO EN ISO 10545-1 PASS ACCORDING EN ISO 10545-1	NESSUN DANNO NO DAMAGE
	RESISTENZA AL GELO FROST RESISTANCE - FROSTBESTÄNDIGKEIT RESISTANCE AU GEL - RESISTENCIA AL HIELO МОРОЗОСТОЙКОСТЬ - 耐冻性	EN ISO 10545-12	TEST SUPERATO SECONDO EN ISO 10545-1 PASS ACCORDING EN ISO 10545-1	NESSUN DANNO NO DAMAGE
	RESISTENZA ALL'ATTACCO CHIMICO RESISTANCE TO CHEMICALS - CHEMIKALIENBESTÄNDIGKEIT RESISTANCE A L'ATTAQUE CHIMIQUE - RESISTENCIA QUÍMICA ХИМИЧЕСКАЯ СТОЙКОСТЬ - 耐化学品作用	EN ISO 10545-13	UB MIN.	A LA HA
	RESISTENZA ALLE MACCHIE RESISTANCE TO STAINS - FLECKENBESTÄNDIGKEIT RESISTANCE AUX TACHES - RESISTENCIA A LAS MANCHAS УСТОЙЧИВОСТЬ К ПЯТНООБРАЗОВАНИЮ - 防污性	EN ISO 10545-14	VALORE DICHIARATO DECLARED VALUE	5
	CESSIONE DI PIOMBO E CADMIO LEAD AND CADMIUM DISCHARGE - ABGABE VON BLEI UND CADMIUM PERTE DE PLOMB ET CADMIUM - CESIÓN DE PLOMO Y CADMIO ВЫДЕЛЕНИЕ СВИНЦА И КАДМИЯ - 铅和镉的排放	EN ISO 10545-15	VALORE DICHIARATO DECLARED VALUE	< AL LIMITE DI RILEVAMENTO < THAN INSTRUMENT LIMIT
		DM 236/89 BCRA	> 0,40	-
		ANSI A326.3	Wet and Dry	-
		AS 4586	-	-
		DIN 51130	-	R9
		DIN 51097	-	-
		UNE 41901	≥ CL1	-
		BS 7976 sl.96-4S	Wet and Dry	-
		BS 7976 sl.55-TRL	Wet and Dry	-

Per i certificati specifici, contattare Mirage SpA - For specific certificates, please contact Mirage SpA - Für die speziellen Zertifikate wenden Sie sich bitte an Mirage SpA - Pour les certificats spécifiques, veuillez contacter Mirage SpA
 Para los certificados específicos, contactar Mirage SpA - Для сертификатов обращайтесь в компанию Mirage SpA - 关于具体的证书, 请联系 Mirage SpA 公司



WALL: Liverpool **MT 06** 600x1200 / 24"x48" NAT RECT
FLOOR: Reading **MT 07** 600x600 / 24"x24" NAT RECT

MÔTLEY

**A timeless style, where
minimalism becomes an
expressive and design language.**

The collection comes from the mixing of classic slates obtained by splitting, with sedimentary stones with a fine background grain and clearer chromatic transitions. The fusion of the two natures generates a new aesthetic reference, which does not exist in nature.



WALL: Rio **MT 01** 1200x2780 / 48"x110" SP RECT
FLOOR: Rio **MT 01** 600x600 / 24"x24" NAT RECT



COLORI

Colours | Farben | Couleurs | Colores | Цветов | 种颜色



OUTDOOR WALL: MAND Terracotta **MD 03** DAWN 300x450 / 12"x18" NOT RECT
 INDOOR FLOOR: Altamont **MT 04** 600x1200 / 24"x48" NAT RECT
 OUTDOOR FLOOR: Altamont **MT 04** 600x1200 / 24"x48" ST RECT EVO_2/E" ± 20 mm





INDOOR FLOOR: Liverpool **MT 06** 1200x1200 / 48"x48" NAT RECT
OUTDOOR FLOOR: Liverpool **MT 06** 600x900 / 24"x36" ST RECT EVO_2/E" 20 mm

COLORI

Colours | Farben | Couleurs | Colores | Цветов | 种颜色

RIO MT 01



Formati Nominali Nominal Sizes		Superficie Finish	Spessore mm Thickness mm
300x600 / 12"x24"	NAT / SP RECT	9	
600x600 / 24"x24"	NAT / SP / ST RECT	9	
600x1200 / 24"x48"	NAT / SP / ST RECT	9	
1200x1200 / 48"x48"	SP RECT	9	
1200x2780 / 48"x110"	SP RECT	6	

Stucchi consigliati Recommended grouts		
KERAKOLL	05	
MAPEI	111 Grigio Argento	
LATICRETE	88 Silver Shadow	



ALTAMONT MT 04



Formati Nominali Nominal Sizes		Superficie Finish	Spessore mm Thickness mm
300x600 / 12"x24"	NAT / SP RECT	9	
600x600 / 24"x24"	NAT / SP / ST RECT	9	
600x1200 / 24"x48"	NAT / SP / ST RECT	9	
1200x1200 / 48"x48"	SP RECT	9	
1200x2780 / 48"x110"	SP RECT	6	
600x600 / 24"x24"	ST RECT	20	
600x1200 / 24"x48"	ST RECT	20	
600x900 / 24"x36"	ST RECT	20	

Stucchi consigliati Recommended grouts		
KERAKOLL	07	
MAPEI	110 Manhattan 2000	
LATICRETE	89 Smoke Grey	



MONTEREY MT 02



Formati Nominali Nominal Sizes		Superficie Finish	Spessore mm Thickness mm
300x600 / 12"x24"	NAT / SP RECT	9	
600x600 / 24"x24"	NAT / SP / ST RECT	9	
600x1200 / 24"x48"	NAT / SP / ST RECT	9	
1200x1200 / 48"x48"	SP RECT	9	
1200x2780 / 48"x110"	SP RECT	6	
600x600 / 24"x24"	ST RECT	20	
600x1200 / 24"x48"	ST RECT	20	
600x900 / 24"x36"	ST RECT	20	

Stucchi consigliati Recommended grouts		
KERAKOLL	43	
MAPEI	111 Grigio Argento	
LATICRETE	90 Light Pewter	



WOODSTOCK MT 05



Formati Nominali Nominal Sizes		Superficie Finish	Spessore mm Thickness mm
300x600 / 12"x24"	NAT / SP RECT	9	
600x600 / 24"x24"	NAT / SP / ST RECT	9	
600x1200 / 24"x48"	NAT / SP / ST RECT	9	
1200x1200 / 48"x48"	SP RECT	9	
1200x2780 / 48"x110"	SP RECT	6	
600x600 / 24"x24"	ST RECT	20	
600x1200 / 24"x48"	ST RECT	20	
600x900 / 24"x36"	ST RECT	20	

Stucchi consigliati Recommended grouts		
KERAKOLL	06	
MAPEI	112 Grigio Medio	
LATICRETE	78 Sterling Silver	



WEMBLEY MT 03



Formati Nominali Nominal Sizes		Superficie Finish	Spessore mm Thickness mm
300x600 / 12"x24"	NAT / SP RECT	9	
600x600 / 24"x24"	NAT / SP / ST RECT	9	
600x1200 / 24"x48"	NAT / SP / ST RECT	9	
1200x1200 / 48"x48"	SP RECT	9	
1200x2780 / 48"x110"	SP RECT	6	
600x600 / 24"x24"	ST RECT	20	
600x1200 / 24"x48"	ST RECT	20	
600x900 / 24"x36"	ST RECT	20	

Stucchi consigliati Recommended grouts		
KERAKOLL	06	
MAPEI	112 Grigio Medio	
LATICRETE	78 Sterling Silver	



LIVERPOOL MT 06



Formati Nominali Nominal Sizes		Superficie Finish	Spessore mm Thickness mm
300x600 / 12"x24"	NAT / SP RECT	9	
600x600 / 24"x24"	NAT / SP / ST RECT	9	
600x1200 / 24"x48"	NAT / SP / ST RECT	9	
1200x1200 / 48"x48"	SP RECT	9	
1200x2780 / 48"x110"	SP RECT	6	
600x600 / 24"x24"	ST RECT	20	
600x1200 / 24"x48"	ST RECT	20	
600x900 / 24"x36"	ST RECT	20	

Stucchi consigliati Recommended grouts		
KERAKOLL	09	
MAPEI	112 Grigio Medio	
LATICRETE	78 Sterling Silver	



EFFETTO PIETRA

COLORI

Colours | Farben | Couleurs | Colores | Цветов | 种颜色

READING MT 07



Formati Nominali Nominal Sizes	Superficie Finish	Spessore mm Thickness mm
300x600 / 12"x24"	NAT / SP RECT	9
600x600 / 24"x24"	NAT / SP RECT	9
600x1200 / 24"x48"	NAT / SP RECT	9

Stucchi consigliati Recommended grouts		
KERAKOLL	09	
MAPEI	113 Grigio Cemento	
LATICRETE	60 Dusty Grey	



GLASTONBURY MT 08



Formati Nominali Nominal Sizes	Superficie Finish	Spessore mm Thickness mm
300x600 / 12"x24"	NAT / SP RECT	9
600x600 / 24"x24"	NAT / SP RECT	9
600x1200 / 24"x48"	NAT / SP RECT	9

Stucchi consigliati Recommended grouts		
KERAKOLL	11	
MAPEI	114 Antracite	
LATICRETE	45 Raven	



RIASSUNTIVO FORMATI ED IMBALLI

Summary of sizes and packaging | Übersicht über Formate und Verpackungen | Récapitulatif formats et emballages
Sinóptico de formatos y embalajes | Краткая информация о форматах и упаковках | 规格和包装概述

		300x600 12"x24"				600x600 24"x24"		600x1200 24"x48"		1200x1200 48"x48"	
9 mm											
Formati Nominali Nominal Sizes											
Tutti i formati sono rettificati. All sizes are rectified.											
Superficie Finish		NAT	SP	NAT	SP	ST	NAT	SP	ST	SP	
	RIO MT 01	V2	■	■	■	■	■	■	■	■	
	MONTEREY MT 02	V2	■	■	■	■	■	■	■	■	
	WEMBLEY MT 03	V2	■	■	■	■	■	■	■	■	
	ALTAMONT MT 04	V2	■	■	■	■	■	■	■	■	
	WOODSTOCK MT 05	V2	■	■	■	■	■	■	■	■	
	LIVERPOOL MT 06	V2	■	■	■	■	■	■	■	■	
	READING MT 07	V2	■	■	■	-	■	■	-	■	
	GLASTONBURY MT 08	V2	■	■	■	-	■	■	-	■	
	Peso lordo per scatola Gross weight per box	25,58	25,58	22,13	22,13	22,12	29,56	29,56	30,00	61,56	
	Pezzi per scatola Pieces for box	7	3	3	3	3	2	2	2	2	
	mq. scatola sqm. box	1,26	1,08	1,08	1,08	1,08	1,44	1,44	1,44	2,88	
	Scatole / Full pallet boxes / Full pallet	40	40	40	40	40	35	35	35	20	
	mq. pallet sqm. pallet	50,40	43,20	43,20	43,20	43,20	50,40	50,40	50,40	57,60	

TUTTI I FORMATI IN 9 MM NAT SONO REALIZZATI CON LA TECNOLOGIA PERFORMA.
All 9 mm NAT sizes are produced with PERFORMA technology.

		1200x2780 48"x110"	
6 mm			
Formati Nominali Nominal Sizes			
Tutti i formati sono rettificati. All sizes are rectified.			
Superficie Finish		SP	
	RIO MT 01	V2	■
	MONTEREY MT 02	V2	■
	WEMBLEY MT 03	V2	■
	ALTAMONT MT 04	V2	■
	WOODSTOCK MT 05	V2	■
	LIVERPOOL MT 06	V2	■
	Peso lordo per scatola Gross weight per box		
	Pezzi per scatola Pieces for box	Please refer to page 588	
	mq. scatola sqm. box		
	Scatole / Full pallet boxes / Full pallet		
	mq. pallet sqm. pallet		

Per tutti i grandi formati è possibile prevedere, su richiesta, e con un lotto minimo l'applicazione di una stuoia in fibra di vetro.
For big sizes, a fibreglass mat can be applied on request, with a minimum production batch.

ACCORDIMENTI SPECIFICI PER L'APPLICAZIONE DELLE GRANDI LASTRE IN 6 MM DI SPESSORE: p. 582 | Precautions for 6mm big slabs applications: page 582 | spezifische Anweisungen zur Nutzung der Grossformate in 6mm: seite 582 | Precauciones específicas para la aplicación de las grandes placas en 6 mm de espesor: page 582 | Precautions spécifiques pour la pose des grandes plaques en 6mm d'épaisseur: página 582 | специальные предосторожности для укладки больших плит толщиной 6 мм : страница 582

		600x600 24"x24"		600x1200 24"x48"		600x900 24"x36"	
20 mm							
Formati Nominali Nominal Sizes							
Tutti i formati sono rettificati. All sizes are rectified.							
Superficie Finish		ST		ST		ST	
	MONTEREY MT 02	V2	■	■	■	■	■
	WEMBLEY MT 03	V2	■	■	■	■	■
	ALTAMONT MT 04	V2	■	■	■	■	■
	WOODSTOCK MT 05	V2	■	■	■	■	■
	LIVERPOOL MT 06	V2	■	■	■	■	■
	Peso lordo per scatola Gross weight per box	31,15		32,00		47,00	
	Pezzi per scatola Pieces for box	2		1		2	
	mq. scatola sqm. box	0,72		0,72		1,08	
	Scatole / Full pallet boxes / Full pallet	30		35		24	
	mq. pallet sqm. pallet	21,60		25,20		25,92	

MY NOTES

.....

.....

.....

.....

.....











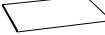



Maggiori informazioni
More information













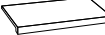
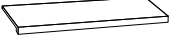

NAT: Naturale | Natural | Natur/unpoliert | Naturelle | Natural | Натуральный | 天然
ST: Strutturata | Structured | Strukturiert | Structuré | Estructurado | Труктурированный | 结构
SP: Spazzolata

PEZZI SPECIALI

Special pieces | Sonderstücke | Pièces spéciales | Piezas especiales | специальные изделия | 特殊件

	 Battiscopa*	 Gradino A*	 Gradino A*	 Gradino G*	 Unico 2.0
 Pezzi speciali Special pieces	72x600 27/8"x24"	300x600 12"x24"	330x1200 13 1/8"x48"	300x600 12"x24"	300x600x20 12"x24"x3/4"
 Superficie Finish	NAT/SP	NAT/SP	NAT/SP	NAT/SP	ST
 RIO MT 01	■	■	■	■	-
 MONTEREY MT 02	■	■	■	■	■
 WEMBLEY MT 03	■	■	■	■	■
 ALTAMONT MT 04	■	■	■	■	■
 WOODSTOCK MT 05	■	■	■	■	■
 LIVERPOOL MT 06	■	■	■	■	■
 READING MT 07	■	■	■	■	-
 GLASTONBURY MT 08	■	■	■	■	-
 Pezzi per scatola Pieces for box	10	7	4	7	3

* Finitura a becco di civetta | One-round edge shaping | Ausführung mit Eckabrundung | Façonnage à bord rond | Acabado canto romo | Плитка с завалом | 鹰嘴边缘处理

	 Gradino B ang.	 Gradino B	 Gradino B	 Elemento L
 Pezzi speciali Special pieces	330x330 13 1/8"x13 1/8"	330x600 13 1/8"x24"	330x1200 13 1/8"x48"	165x300 6 3/8"x12"
 Superficie Finish	NAT/SP	NAT/SP	NAT/SP	NAT
 RIO MT 01	■	■	■	■
 MONTEREY MT 02	■	■	■	■
 WEMBLEY MT 03	■	■	■	■
 ALTAMONT MT 04	■	■	■	■
 WOODSTOCK MT 05	■	■	■	■
 LIVERPOOL MT 06	■	■	■	■
 READING MT 07	■	■	■	■
 GLASTONBURY MT 08	■	■	■	■
 Pezzi per scatola Pieces for box	4	4	2	7

NAT: Naturale | Natural | Natur/unpoliert | Naturelle | Natural | Натуральный | 天然
ST: Strutturata | Structured | Strukturiert | Structuré | Estructurado | Труктурированный | 结构
SP: Spazzolata

DECORI

Decors | Dekore | Decors | Decoros | Декоры | 装饰砖

 **Mosaico 36T NAT**
300x300 / 12"x12"
Tessere 48x48 / 2"x2"



RIO MT 01



MONTEREY MT 02

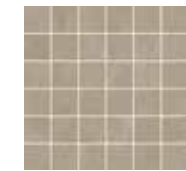

WEMBLEY MT 03

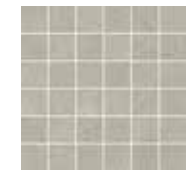

ALTAMONT MT 04

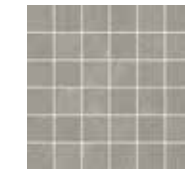

WOODSTOCK MT 05

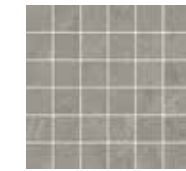

LIVERPOOL MT 06

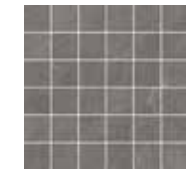

READING MT 07

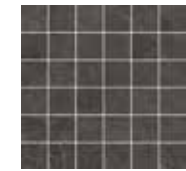

GLASTONBURY MT 08

 **Portnoy NAT**
300x300 / 12"x12"



RIO MT 01



MONTEREY MT 02



WEMBLEY MT 03



ALTAMONT MT 04



WOODSTOCK MT 05



LIVERPOOL MT 06



READING MT 07



GLASTONBURY MT 08

 **Fish NAT (Spaccatella)**
280x280 / 11"x11"



RIO MT 01



MONTEREY MT 02



WEMBLEY MT 03



ALTAMONT MT 04



WOODSTOCK MT 05



LIVERPOOL MT 06



READING MT 07



GLASTONBURY MT 08

 **Pezzi per scatola**
Pieces for box

Mosaico 36T 6

Portnoy 6

Fish 6

MOSAICO 36T, PORTNOY, FISH:

Decoro su rete | Mesh-backed decoration | Dekor auf netz | Décor sur filet | Decoración en red | Декор в сету | 网板背帖装饰件

DECORI

Decors | Dekore | Decors | Decoros | Декоры | 装饰砖

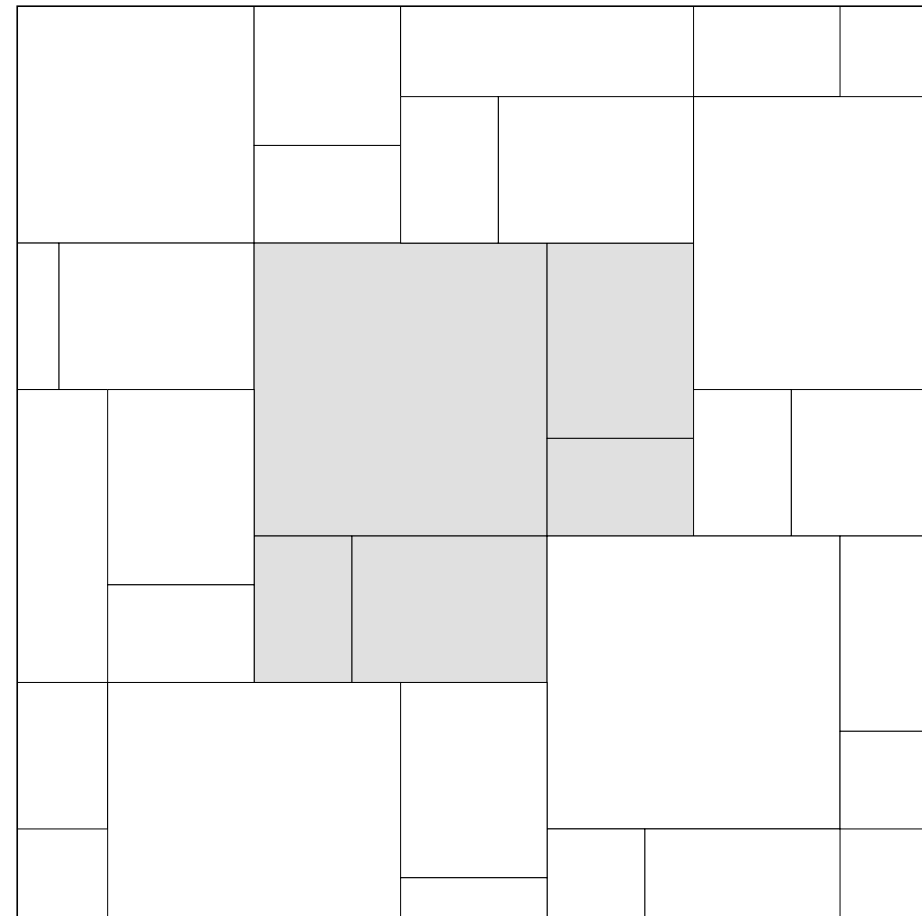

KIT FONTAINBLEAU

ST R11 A+B+C

(bordo irregolare/irregular edge)

± 9 mm

600x600 / 24"x24"

300x400 / 12"x16"

300x200 / 12"x8"

Colori disponibili | Available colours



MONTEREY MT 02



WEMBLEY MT 03



ALTAMONT MT 04



Pezzi per scatola
Pieces for box

Kit Fontainbleau 1 Kit

600x600 / 24"x24" = 1 pc

300x400 / 12"x16" = 2 pcs

300x200 / 12"x8" = 2 pcs

CARATTERISTICHE TECNICHE

Technical specifications | Technische Eigenschaften | Caractéristiques techniques | Características técnicas | Технические характеристики | 技术特征

STANDARD EN 14411 - G

	CARATTERISTICHE TECNICHE TECHNICAL DATA TECHNISCHE DATEN CARACTERISTIQUES TECHNIQUES CARACTERÍSTICAS TÉCNICAS ТЕХНИЧЕСКИЕ ХАРАКТЕРИСТИКИ 技术特征	NORMA STANDARD NORM NORME NORMA НОРМА 标准	VALORI PRESCRITTI DALLE NORME EN 14411 - G INTERNATIONAL STANDARDS EN 14411 - G INTERNATIONALE NORMWERTE EN 14411 - G VALEURS PREVUES PAR LES NORMES EN 14411 - G VALORES PREVISTOS POR LAS NORMAS EN 14411 - G ПРЕДУСМОТРЕННЫЕ СТАНДАРТОВ EN 14411-G EN 14411 - G标准规定值	*VALORE MEDIO MIRAGE MIRAGE AVERAGE VALUE MIRAGE MITTELWERT VALEURS MOYEN MIRAGE VALORES MEDIO MIRAGE СРЕДНЕЕ ЗНАЧЕНИЕ MIRAGE MIRAGE平均值
	CARATTERISTICHE DIMENSIONALI - SIZE CHARACTERISTICS - MASSEIGENSCHAFTEN DETERMINATION DES CARACTERISTIQUES DIMENSIONNELLES - CARACTERÍSTICAS DIMENSIONALES - РАЗМЕРНЫЕ ХАРАКТЕРИСТИКИ - 尺寸特征			
	LATI SIDES - SEITEN COTES - CANTOS РАЗМЕРЫ СТОРОН - 侧边	EN ISO 10545-2	± 0,3% MAX (± 1,0 mm MAX)	CONFORME COMPLYING
	SPESSORE THICKNESS - DICKE EPAISSEUR - ESPESOR ТОЛЩИНА - 厚度	EN ISO 10545-2	± 5,0% MAX (± 0,5 mm MAX)	CONFORME COMPLYING
	RETTILINEITÀ DEGLI SPIGOLI STRAIGHTNESS OF SIDES - GERADLINIGKEIT DER KANTEN RECTITUDE DES ARETES - RECTITUD DE LOS CANTOS КОСОУГОЛЬНОСТЬ - 边角平直度	EN ISO 10545-2	± 0,3% MAX (± 0,8 mm MAX)	CONFORME COMPLYING
	ORTOGONALITÀ RECTANGULARITY - RECHTWINKLIGKEIT PERPENDICULARITÉ - ORTOGONALIDAD КРИВИЗНА СТОРОН - 直角度	EN ISO 10545-2	± 0,3% MAX (± 1,5 mm MAX)	CONFORME COMPLYING
	PLANARITÀ SURFACE FLATNESS - EBENFLÄCHIGKEIT PLANEITE DE SURFACE - PLANEIDAD КРИВИЗНА ЛИЦЕВОЙ ПОВЕРХНОСТИ - 平整度	EN ISO 10545-2	± 0,4% MAX (± 1,8 mm MAX)	CONFORME COMPLYING
	ASSORBIMENTO D'ACQUA WATER ABSORPTION - WASSERAUFNAHME ABSORPTION D'EAU - ABSORCIÓN DE AGUA ВОДОПОГЛОЩЕНИЕ - 吸水率	EN ISO 10545-3	≤ 0,5%	≤ 0,1%
	RESISTENZA ALLA FLESSIONE FLEXION RESISTANCE - BIEGEFESTIGKEIT RESISTANCE A LA FLEXION - RESISTENCIA A LA FLEXIÓN ПРЕДЕЛ ПРОЧНОСТИ ПРИ ИЗГИБЕ - 抗弯强度	EN ISO 10545-4	S ≥ 700 N (< 7,5 mm) S ≥ 1.300 N (> 7,5 mm) R ≥ 35 N/mm².	±6 mm: S ≥ 1100 N R ≥ 45 N/mm² ±9 mm: S ≥ 2.400 N R ≥ 48 N/mm² ±20 mm: S ≥ 12.500 N R ≥ 48 N/mm²
	RESISTENZA ALL'URTO IMPACT RESISTANCE - STOSSFESTIGKEIT RESISTANCE AUX CHOCES - RESISTENCIA A LOS GOLPES УДАРОСТОЙКОСТЬ - 抗冲击强度	EN ISO 10545-5	VALORE DICHIARATO DECLARED VALUE	> 0,80
	RESISTENZA ALL'ABRASIONE ABRASION RESISTANCE - ABRIEBFESTIGKEIT RESISTANCE A L'ABRASION - RESISTENCIA A LA ABRASIÓN СТОЙКОСТЬ К ИСТИРАНИЮ - 耐磨强度	EN ISO 10545-6	≤ 175 mm³	< 150 mm³
	COEFFICIENTE DI DILATAZIONE TERMICA LINEARE COEFFICIENT OF LINEAR THERMAL-EXPANSION - LINEARER WÄRMEAUDEHNUNGSKOEFFIZIENT COEFFICIENT DE DILATATION THERMIQUE LINEAIRE - COEFICIENTE DE DILATACIÓN TÉRMICA LINEAL КОЭФФИЦИЕНТ ЛИНЕЙНОГО ТЕРМИЧЕСКОГО РАСТЯЖЕНИЯ - 线性热膨胀系数	EN ISO 10545-8	-	α=6,6x10 ⁻⁶ °C ⁻¹
	RESISTENZA AGLI SBALZI TERMICI RESISTANCE TO THERMAL SHOCKS - BESTÄNDIGKEIT GEGEN TEMPERATURSCHWANKUNGEN RESISTANCE AUX CHOCES THERMIQUES - RESISTENCIA A LOS CHOQUES TÉRMICOS СТОЙКОСТЬ К ПЕРЕПАДАМ ТЕМПЕРАТУРЫ - 耐热突变性	EN ISO 10545-9	TEST SUPERATO SECONDO EN ISO 10545-1 PASS ACCORDING EN ISO 10545-1	NESSUN DANNO NO DAMAGE
	RESISTENZA AL GELO FROST RESISTANCE - FROSTBESTÄNDIGKEIT RESISTANCE AU GEL - RESISTENCIA AL HIELO МОРОЗОСТОЙКОСТЬ - 耐冻性	EN ISO 10545-12	TEST SUPERATO SECONDO EN ISO 10545-1 PASS ACCORDING EN ISO 10545-1	NESSUN DANNO NO DAMAGE
	RESISTENZA ALL'ATTACCO CHIMICO RESISTANCE TO CHEMICALS - CHEMIKALIENBESTÄNDIGKEIT RESISTANCE A L'ATTAQUE CHIMIQUE - RESISTENCIA QUÍMICA ХИМИЧЕСКАЯ СТОЙКОСТЬ - 耐化学品作用	EN ISO 10545-13	B MIN.	A LA HA
	RESISTENZA ALLE MACCHIE RESISTANCE TO STAINS - FLECKENBESTÄNDIGKEIT RESISTANCE AUX TACHES - RESISTENCIA A LAS MANCHAS УСТОЙЧИВОСТЬ К ПЯТНООБРАЗОВАНИЮ - 防污性	EN ISO 10545-14	VALORE DICHIARATO DECLARED VALUE	5
	CESSIONE DI PIOMBO E CADMIO LEAD AND CADMIUM DISCHARGE - ABGABE VON BLEI UND CADMIUM PERTE DE PLOMB ET CADMIUM - CESIÓN DE PLOMO Y CADMIO ВЫДЕЛЕНИЕ СВИНЦА И КАДМИЯ - 铅和镉的排放	EN ISO 10545-15	VALORE DICHIARATO DECLARED VALUE	< AL LIMITE DI RILEVAMENTO < THAN INSTRUMENT LIMIT
	SCIVOLOSITÀ SKID RESISTANCE - RUTSCHWERT GLISSANCE - ADHERENCIA СКОЛЬЗКОСТЬ - 防滑性			SP NAT ST ST 20mm
	DM 236/89 BCRA	> 0,40	> 0,40 > 0,40 > 0,40 > 0,40	
	ANSI A326.3	Wet and Dry	≥ 0,42 ≥ 0,42 ≥ 0,55 ≥ 0,55	
	AS 4586	-	P2 P3 - -	
	DIN 51130	-	R9 R10 R11 R11	
	DIN 51097	-	A+B A+B+C A+B+C	
	UNE 41901	≥ CL1	CL1 CL1 CL3 CL3	
	BS 7976 sl.96-4S	Wet and Dry	- ≥ 0,36 ≥ 0,36 ≥ 0,36	
	BS 7976 sl.55-TRL	Wet and Dry	- ≥ 0,36 ≥ 0,36 ≥ 0,36	

Per i certificati specifici, contattare Mirage SpA - For specific certificates, please contact Mirage SpA - Für die speziellen Zertifikate wenden Sie sich bitte an Mirage SpA - Pour les certificats spécifiques, veuillez contacter Mirage SpA
Para los certificados específicos, contactar Mirage SpA - Для сертификатов обращайтесь в компанию Mirage SpA - 关于具体的证书, 请联系Mirage SpA公司



INDOOR FLOOR: Gris Belge **NE 31** 600x600 / 24"x24" NAT RECT
OUTDOOR FLOOR: Gris Belge **NE 31** 600x1200 / 24"x48" ST RECT EVO_2/E" ± 20 mm

NA.ME

Na.me is the synthesis of NATural and tiME.
Natural like the stones that have made architectural history, Time because this is the time of structural and aesthetic perfection.

Colour harmony, the original depth of colour shades, with detailed grains and inclusions: each slab is unique, in harmony with the most innovative urban and residential furnishing trends.



FLOOR: Bourgogne **NE 12** 600x600 / 24"x24" ST RECT EVO_2/E" ± 20 mm



COLORI

Colours | Farben | Couleurs | Colores | Цветов | 种颜色



FLOOR: Jura Beige **NE 10** 600x1200 / 24"x48" NAT RECT
COUNTER: Jura Beige **NE 10** NAT

COLORI

Colours | Farben | Couleurs | Colores | Цветов | 种颜色

JURA BEIGE NE 10



Formati Nominali Nominal Sizes	Superficie Finish	Spessore mm Thickness mm
300x600 / 12"x24"	NAT / BC RECT	9
600x600 / 24"x24"	NAT RECT	9
600x1200 / 24"x48"	NAT RECT	9
600x600 / 24"x24"	ST RECT	20
450x900 / 18"x36"	ST RECT	20
600x1200 / 24"x48"	ST RECT	20

Stucchi consigliati Recommended grouts		
KERAKOLL	07	
MAPEI	111 Grigio Argento	
LATICRETE	88 Silver Shadow	

BOURGOGNE NE 12



Formati Nominali Nominal Sizes	Superficie Finish	Spessore mm Thickness mm
300x600 / 12"x24"	NAT / BC RECT	9
600x600 / 24"x24"	NAT RECT	9
600x1200 / 24"x48"	NAT RECT	9
600x600 / 24"x24"	ST RECT	20
450x900 / 18"x36"	ST RECT	20
600x1200 / 24"x48"	ST RECT	20

Stucchi consigliati Recommended grouts		
KERAKOLL	06	
MAPEI	110 Manhattan	
LATICRETE	89 Smoke Grey	

GRIS BELGE NE 31



Formati Nominali Nominal Sizes	Superficie Finish	Spessore mm Thickness mm
300x600 / 12"x24"	NAT / BC RECT	9
600x600 / 24"x24"	NAT RECT	9
600x1200 / 24"x48"	NAT RECT	9
600x600 / 24"x24"	ST RECT	20
450x900 / 18"x36"	ST RECT	20
600x1200 / 24"x48"	ST RECT	20

Stucchi consigliati Recommended grouts		
KERAKOLL	09	
MAPEI	113 Grigio Cemento	
LATICRETE	34 Sand Stone	

RIASSUNTIVO FORMATI ED IMBALLI

Summary of sizes and packaging | Übersicht über Formate und Verpackungen | Récapitulatif formats et emballages
Sinóptico de formatos y embalajes | Краткая информация о форматах и упаковках | 规格和包装概述

Formati Nominali Nominal Sizes		300x600 12"x24"	600x600 24"x24"	600x1200 24"x48"	
Tutti i formati sono rettificati. All sizes are rectified.					
Superficie Finish		NAT	BC	NAT	NAT
JURA BEIGE NE 10	V2	■	■	■	■
BOURGOGNE NE 12	V2	■	■	■	■
GRIS BELGE NE 31	V2	■	■	■	■
Peso lordo per scatola Gross weight per box		26,18	26,18	23,07	30,00
Pezzi per scatola Pieces for box		7	7	3	2
mq. scatola sqm. box		1,26	1,26	1,08	1,44
Scatole / Full pallet boxes / Full pallet		40	40	40	35
mq. pallet sqm. pallet		43,20	43,20	43,20	50,40

Formati Nominali Nominal Sizes		600x600 24"x24"	450x900 18"x36"	600x1200 24"x48"
Tutti i formati sono rettificati. All sizes are rectified.				
Superficie Finish		ST	ST	ST
JURA BEIGE NE 10	V2	■	■	■
BOURGOGNE NE 12	V2	■	■	■
GRIS BELGE NE 31	V2	■	■	■
Peso lordo per scatola Gross weight per box		31,14	34,40	32,00
Pezzi per scatola Pieces for box		2	2	1
mq. scatola sqm. box		0,72	0,81	0,72
Scatole / Full pallet boxes / Full pallet		30	27	35
mq. pallet sqm. pallet		21,60	21,87	25,20

PEZZI SPECIALI

Special pieces | Sonderstücke | Pièces spéciales | Piezas especiales | специальные изделия | 特殊件

	Battiscopa*	Gradino A*	Gradino A*	Gradino G*	Gradino B ang.	Gradino B	Gradino B		
	72x600 2 7/8"x24"	300x600 12"x24"	330x1200 13 1/8"x48"	300x600 12"x24"	330x330 13 1/8"x13 1/8"	330x600 13 1/8"x24"	330x1200 13 1/8"x48"		
Superficie Finish	NAT	NAT	BC	NAT	NAT	BC	NAT	NAT	
JURA BEIGE NE 10	■	■	■	■	■	■	■	■	
BOURGOGNE NE 12	■	■	■	■	■	■	■	■	
GRIS BELGE NE 31	■	■	■	■	■	■	■	■	
Pezzi per scatola Pieces for box	10	7	7	2	7	7	4	4	2

* Finitura a becco di civetta | One-round edge shaping | Ausführung mit Eckabrundung | Façonnage à bord rond | Acabado canto romo | Плитка с завалом | 鹰嘴边缘处理

NAT: Naturale | Natural | Natur/unpoliert | Naturelle | Natural | Натуральный | 天然
ST: Strutturata | Structured | Strukturiert | Structuré | Estructurado | Структурированный | 结构
BC: Bocciardata

DECORI

Decors | Dekore | Decors | Decoros | Декоры | 装饰砖

Mosaico 36T NAT
300x300 / 12"x12"
Tessere 48x48 / 2"x2"



Mattoncino NAT
300x300 / 12"x12"
Tessere 24x48 / 1"x2"



Portnoy NAT
300x300 / 12"x12"



MATTONCINO, MOSAICO 36T, PORTNOY:
Decoro su rete. | Mesh-backed decoration. | Dekor auf netz. | Décor sur filet. | Decoración en red. | Декор в сети. | 网板背帖装饰件

MY NOTES

.....

.....

.....

.....

NAT: Naturale | Natural | Natur/unpoliert | Naturelle | Natural | Натуральный | 天然

DECORAZIONE CUSTOM

Custom decoration | Custom-Dekoration | Custom Décoration | Custom Decoration | Декоративный элемент | Custom装饰系列。



Colori disponibili | Colours available



Decorazione Custom è la soluzione ideata per personalizzare i tuoi spazi a rivestimento e pavimento, rendendoli assolutamente unici.

Viene realizzata su misura in base alle dimensioni e agli ingombri specifici (porte, finestre, vani...) dell'area di interesse, rispondendo in questo modo ad ogni esigenza progettuale.

[EN]
Custom Decoration is a solution designed to customise floors and walls and make them truly one-of-a-kind. It is made to measure to fit specific dimensions and cater for the openings (doors, windows, rooms...) in the particular area, meeting any floor plan demands.

[DE]
Custom-Dekoration ist die Lösung, die wir uns ausgedacht haben, um die Verkleidungen und Fußböden Ihrer Räume persönlich und absolut einzigartig zu gestalten. Sie wird den spezifischen Abmessungen und Ausmaßen (Türe, Fenster, Räume...) des betroffenen Bereichs entsprechend maßgefertigt und stellen daher die Antwort auf alle Anforderungen bei der Planung dar.

[FR]
Custom Décoration est conçue pour personnaliser vos espaces dont elle revêt aussi bien les murs que les sols auxquels elle donne un cachet tout à fait unique. Elle est réalisée sur mesure, selon les cotes d'encombrement de l'espace à revêtir, en tenant compte de la présence de portes, fenêtres et autres contraintes, de manière à satisfaire toutes les exigences conceptuelles.

[ES]
Custom Decoration es la solución ideal para personalizar los revestimientos y suelos de tus espacios, convirtiéndolos en lugares únicos. Es hecha a medida según las medidas y las aberturas específicas (puertas, ventanas, huecos, etc.) de la zona de interés, respondiendo así a todas las necesidades de diseño.

[RU]
Декоративный элемент – это решение, разработанное для того, чтобы персонализировать пространство стен и пола, сделать его уникальным. Он выполняется по заказу исходя из расстояний и особых размеров (двери, окна, ниши и пр) пространства, удовлетворяя, таким образом, любое требование проекта.

[中文]
Custom (个性化) 装饰系列是让您的空间的墙壁和地板装饰个性化的理想解决方案, 从而令它们绝对独一无二。有关区域根据具体的尺寸和空间(门、窗、房间...), 通过这种方式可满足每个设计要求。

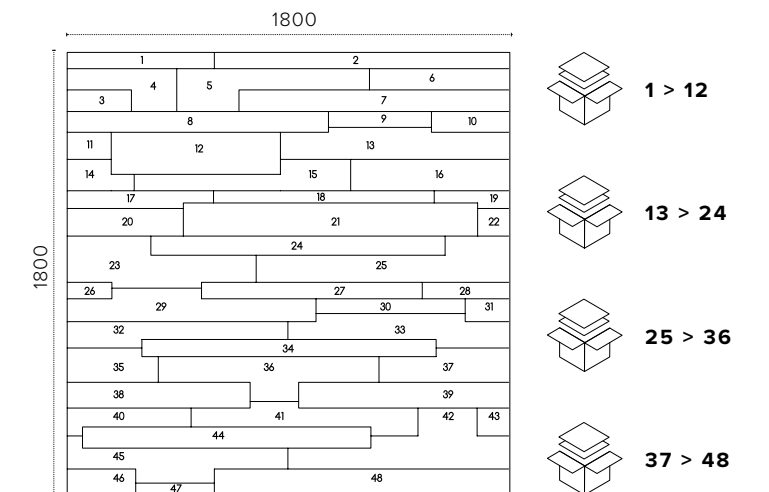

La Decorazione Custom verrà consegnata imballata sequenzialmente, per agevolare le operazioni di posa del materiale.

[EN]
Custom Decoration will be delivered in sequential boxes to facilitate the tiling process.

[DE]
Die Custom-Dekoration wird in der richtigen Reihenfolge verpackt geliefert, um das Verlegen des Materials zu erleichtern.

[FR]
Custom Décoration sera livré emballé dans un ordre séquentiel, pour faciliter la réalisation du calepinage.

[ES]
Custom Decoration se entregará embalada en forma secuencial para agilizar los trabajos de colocación del material.

[RU]
Декоративный элемент Custom будет отправлен в последовательно упакованном виде с целью облегчить процесс укладки материала.

[中文]
为了方便材料的铺设施工, Custom装饰系列将按顺序包装交付。(参阅第59页)

Maggiori informazioni
More information





CARATTERISTICHE TECNICHE

Technical specifications | Technische Eigenschaften | Caractéristiques techniques | Características técnicas | Технические характеристики

STANDARD EN 14411 - G

	CARATTERISTICHE TECNICHE TECHNICAL DATA TECHNISCHE DATEN CARACTERISTIQUES TECHNIQUES CARACTERÍSTICAS TÉCNICAS ТЕХНИЧЕСКИЕ ХАРАКТЕРИСТИКИ 技術特征	NORMA STANDARD NORM NORME NORMA ЗНАЧЕНИЯ 标准	VALORI PRESCRITTI DALLE NORME EN 14411 - G INTERNATIONAL STANDARDS EN 14411 - G INTERNATIONALE NORMWERTE EN 14411 - G VALEURS PREVUES PAR LES NORMES EN 14411 - G VALORES PREVISTOS POR LAS NORMAS EN 14411 - G ПРЕДУСМОТРЕННЫЕ СТАНДАРТОВ EN 14411-G EN 14411 - G标准规定值	*VALORE MEDIO MIRAGE MIRAGE AVERAGE VALUE MIRAGE MITTELWERT VALEURS MOYEN MIRAGE VALOR MEDIO MIRAGE СРЕДНЕЕ ЗНАЧЕНИЕ MIRAGE MIRAGE平均值	
	CARATTERISTICHE DIMENSIONALI - SIZE CHARACTERISTICS - MASSEIGENSCHAFTEN DETERMINATION DES CARACTERISTIQUES DIMENSIONNELLES - CARACTERÍSTICAS DIMENSIONALES - РАЗМЕРНЫЕ ХАРАКТЕРИСТИКИ - 尺寸特征				
	LATI SIDES - SEITEN COTES - CANTOS РАЗМЕРЫ СТОРОН - 側邊	EN ISO 10545-2	± 0,3% MAX (± 1,0 mm MAX)	CONFORME COMPLYING	
	SPESORE THICKNESS - DICKE ÉPAISSEUR - ESPESOR ТОЛЩИНА - 厚度	EN ISO 10545-2	± 5,0% MAX (± 0,5 mm MAX)	CONFORME COMPLYING	
	RETTILINEITÀ DEGLI SPIGLI STRAIGHTNESS OF SIDES - GERADLINIGKEIT DER KANTEN RECTITUDE DES ARETES - RECTITUD DE LOS CANTOS КОСОУГОЛЬНОСТЬ - 边角平直度	EN ISO 10545-2	± 0,3% MAX (± 0,8 mm MAX)	CONFORME COMPLYING	
	ORTOGONALITÀ RECTANGULARITY - RECHTWINKLIGKEIT PERPENDICULARITÉ - ORTOGONALIDAD КРИВИЗНА СТОРОН - 直角度	EN ISO 10545-2	± 0,3% MAX (± 1,5 mm MAX)	CONFORME COMPLYING	
	PLANARITÀ SURFACE FLATNESS - EBENFLÄCHIGKEIT PLANEITE DE SURFACE - PLANEIDAD КРИВИЗНА ЛИЦЕВОЙ ПОВЕРХНОСТИ - 平整度	EN ISO 10545-2	± 0,4% MAX (± 1,8 mm MAX)	CONFORME COMPLYING	
	ASSORBIMENTO D'ACQUA WATER ABSORPTION - WASSERAUFNAHME ABSORPTION D'EAU - ABSORCIÓN DE AGUA ВОДОПОГЛОЩЕНИЕ - 吸水率	EN ISO 10545-3	≤ 0,5%	≤ 0,1%	
	RESISTENZA ALLA FLESSIONE FLEXION RESISTANCE - BIEGEFESTIGKEIT RESISTANCE A LA FLEXION - RESISTENCIA A LA FLEXIÓN ПРЕДЕЛ ПРОЧНОСТИ ПРИ ИЗГИБЕ - 抗弯强度	EN ISO 10545-4	S ≥ 700 N (< 7,5 mm) S ≥ 1.300 N (> 7,5 mm) R ≥ 35 N/mm².	±9 mm: S≥2.400N R≥48 N/mm² ±20 mm: S≥12.500N R≥48 N/mm²	
	RESISTENZA ALL'URTO IMPACT RESISTANCE - STOSSFESTIGKEIT RESISTANCE AUX CHOCES - RESISTENCIA A LOS GOLPES УДАРСТОЙКОСТЬ - 抗冲击强度	EN ISO 10545-5	VALORE DICHIARATO DECLARED VALUE	> 0,80	
	RESISTENZA ALL'ABRASIONE ABRASION RESISTANCE - ABRIEBFESTIGKEIT RESISTANCE A L'ABRASION - RESISTENCIA A LA ABRASIÓN СТОЙКОСТЬ К ИСТИРАНИЮ - 耐磨强度	EN ISO 10545-6	≤ 175 mm³	< 150 mm³	
	COEFFICIENTE DI DILATAZIONE TERMICA LINEARE COEFFICIENT OF LINEAR THERMAL-EXPANSION - LINEARER WÄRMEAUSSDEHNUNGSKOEFFIZIENT COEFFICIENT DE DILATATION THERMIQUE LINEAIRE - COEFICIENTE DE DILATACIÓN TÉRMICA LINEAL КОЭФФИЦИЕНТ ЛИНЕЙНОГО ТЕРМИЧЕСКОГО РАСШИРЕНИЯ - 线性热膨胀系数	EN ISO 10545-8	—	α=6,6x10 ⁻⁶ °C ⁻¹	
	RESISTENZA AGLI SBALZI TERMICI RESISTANCE TO THERMAL SHOCKS - BESTÄNDIGKEIT GEGEN TEMPERATURSCHWANKUNGEN RESISTANCE AUX CHOCES THERMIQUES - RESISTENCIA A LOS CHOQUES TÉRMICOS СТОЙКОСТЬ К ПЕРЕПАДАМ ТЕМПЕРАТУРЫ - 耐热突变性	EN ISO 10545-9	TEST SUPERATO SECONDO EN ISO 10545-1 PASS ACCORDING EN ISO 10545-1	NESSUN DANNO NO DAMAGE	
	RESISTENZA AL GELO FROST RESISTANCE - FROSTBESTÄNDIGKEIT RESISTANCE AU GEL - RESISTENCIA AL HIELO МОРОЗОСТОЙКОСТЬ - 耐冻性	EN ISO 10545-12	TEST SUPERATO SECONDO EN ISO 10545-1 PASS ACCORDING EN ISO 10545-1	NESSUN DANNO NO DAMAGE	
	RESISTENZA ALL'ATTACCO CHIMICO RESISTANCE TO CHEMICALS - CHEMIKALIENBESTÄNDIGKEIT RESISTANCE A L'ATTAQUE CHIMIQUE - RESISTENCIA QUÍMICA ХИМИЧЕСКАЯ СТОЙКОСТЬ - 耐化学品作用	EN ISO 10545-13	B MIN.	A LA HA	
	RESISTENZA ALL'ABRASIONE SUPERFICIALE SURFACE ABRASION RESISTANCE - ABRIEBFESTIGKEIT DER OBERFLÄCHE RESISTANCE À L'ABRASION SUPERFICIELLE - RESISTENCIA A LA ABRASIÓN SUPERFICIAL ХИМИЧЕСКАЯ СТОЙКОСТЬ - 耐表面磨损	EN ISO 10545-7	—	—	
	RESISTENZA ALLE MACCHIE RESISTANCE TO STAINS - FLECKENBESTÄNDIGKEIT RESISTANCE AUX TACHES - RESISTENCIA A LAS MANCHAS УСТОЙЧИВОСТЬ К ПЯТНООБРАЗОВАНИЮ - 防污性	EN ISO 10545-14	VALORE DICHIARATO DECLARED VALUE	5	
	CESSIONE DI PIOMBO E CADMIO LEAD AND CADMIUM DISCHARGE - ABGABE VON BLEI UND CADMIUM PERTE DE PLOMB ET CADMIUM - CESIÓN DE PLOMO Y CADMIUM ВЫДЕЛЕНИЕ СВИНЦА И КАДМИЯ - 铅和镉的排放	EN ISO 10545-15	VALORE DICHIARATO DECLARED VALUE	< AL LIMITE DI RILEVAMENTO < THAN INSTRUMENT LIMIT	
			NAT	BC	ST 20mm
		DM 236/89 BCRA	> 0,40	> 0,40	> 0,40
		ANSI A326.3	Wet and Dry	≥ 0,42	≥ 0,55
		AS 4586	-	P2	P5
		DIN 51130	-	R9	R11
		DIN 51097	-	-	A+B+C
		UNE 41901	≥ CL1	CL1	CL3
		BS 7976 sl.96-4S	Wet and Dry	-	> 0,36
		BS 7976 sl.55-TRL	Wet and Dry	-	-
	SCIVOLOSITÀ SKID RESISTANCE - RUTSCHWERT GLISSANCE - ADHERENCIA СКОЛЬЗКОСТЬ - 防滑性				

Per i certificati specifici, contattare Mirage SpA - For specific certificates, please contact Mirage SpA - Für die speziellen Zertifikate wenden Sie sich bitte an Mirage SpA - Pour les certificats spécifiques, veuillez contacter Mirage SpA
Para los certificados específicos, contactar Mirage SpA - Для сертификатов обращайтесь в компанию Mirage SpA - 关于具体的证书, 请联系Mirage SpA公司



EFFETTO LEGNO

Fado **NA 01** 300x1200 / 12"x48" RD RECT EVO_2/E" ± 20 mm

NAU 2.0

**Nau 2.0 is the encounter
between NATural and Urban.**

Scratches, planing marks, signs of wear
and traces of the artisan's work create
unique planks that bring a touch of
authenticity to any setting.



Indie **NA 02** 300x1200 / 12"x48" RD RECT EVO_2/E" ± 20 mm

COLORI

Colours | Farben | Couleurs | Colores | Цветов | 种颜色



Fado
NA 01



Indie
NA 02

COLORI

Colours | Farben | Couleurs | Colores | Цветов | 种颜色

FADO NA 01



Formati Nominali Nominal Sizes	Superficie Finish	Spessore mm Thickness mm
600x600 / 24"x24" 300x1200 / 12"x48"	RD RECT RD RECT	20 20
Stucchi consigliati Recommended grouts		
KERAKOLL	08	
MAPEI	112 Grigio Medio	
LATICRETE	78 Sterling Silver	

INDIE NA 02



Formati Nominali Nominal Sizes	Superficie Finish	Spessore mm Thickness mm
600x600 / 24"x24" 300x1200 / 12"x48"	RD RECT RD RECT	20 20
Stucchi consigliati Recommended grouts		
KERAKOLL	08	
MAPEI	112 Grigio Medio	
LATICRETE	78 Sterling Silver	

RIASSUNTIVO FORMATI ED IMBALLI

Summary of sizes and packaging | Übersicht über Formate und Verpackungen | Récapitulatif formats et emballages
Sinóptico de formatos y embalajes | Краткая информация о форматах и упаковках | 规格和包装概述

		GO 2/e ± 20 mm	
Formati Nominali Nominal Sizes	600x600 24"x24"	300x1200 12"x48"	
Tutti i formati sono rettificati. All sizes are rectified.			
Superficie Finish	RD	RD	
FADO NA 01	V3		
INDIE NA 02	V3		
Peso lordo per scatola Gross weight per box	31,14	32,00	
Pezzi per scatola Pieces for box	2	2	
mq. scatola sqm. box	0,72	0,72	
Scatole / Full pallet boxes / Full pallet	30	36	
mq. pallet sqm. pallet	21,60	25,92	

La collezione NAU presenta sulle lastre in tutti i formati, nella percentuale di 1 a 30 circa, il logo Mirage a vista. Si tratta di un rafforzamento estetico tipico delle plance effetto legno.

The Mirage logo is visible on the slabs in all sizes, in a percentage of approximately 1 – 30. It is a strengthening visual detail typical of wood-effect planks.

La collection NAU présente sur les plaques, dans tous les formats, dans un pourcentage de 1 à 30 environ, le logo Mirage apparent. Il s'agit d'un renforcement esthétique typique des planches effet bois.

Las placas de la colección NAU presentan en todos sus formatos, en un porcentaje aproximado de 1 a 30, el logotipo Mirage visible. Se trata de un refuerzo estético típico de los tableros efecto madera.

Die Kollektion NAU weist auf einem Anteil von ungefähr 1/30 der Platten aller Formate sichtbar das Mirage-Logo auf. Es handelt sich um eine typische Verschönerung der Holzoptikbretter.

Коллекция NAU присутствует в ассортименте плит всех форматов, в процентном отношении приблизительно 1 к 30, с указанием логотипа Mirage. Это эстетический акцент для плит с эффектом деревянных досок.

NAU系列在各种尺寸的板材上均显示Mirage徽标，比例约为1到30的百分比。它是木纹效果板材的典型美观增强。

MY NOTES

.....

.....

.....

.....

.....

Maggiori informazioni
More information





FLOOR: Indie NA 02 300x1200 / 12"x48" RD RECT EVO_2/E" 20 mm

CARATTERISTICHE TECNICHE

Technical specifications | Technische Eigenschaften | Caractéristiques techniques | Características técnicas | Технические характеристики | 技术特征

STANDARD EN 14411 - G

	CARATTERISTICHE TECNICHE TECHNICAL DATA TECHNISCHE DATEN CARACTERISTIQUES TECHNIQUES CARACTERÍSTICAS TÉCNICAS ТЕХНИЧЕСКИЕ ХАРАКТЕРИСТИКИ 技术特征	NORMA STANDARD NORM NORME NORMA ЗНАЧЕНИЯ 标准	VALORI PRESCRITTI DALLE NORME EN 14411 - G INTERNATIONAL STANDARDS EN 14411 - G INTERNATIONALE NORMWERTE EN 14411 - G VALEURS PREVUES PAR LES NORMES EN 14411 - G VALORES PREVISTOS POR LAS NORMAS EN 14411 - G ПРЕДУСМОТРЕННЫЕ СТАНДАРТОВ EN 14411-G EN 14411 - G标准规定值	*VALORE MEDIO MIRAGE MIRAGE AVERAGE VALUE MIRAGE MITTELWERT VALEURS MOYEN MIRAGE VALOR MEDIO MIRAGE СРЕДНЕЕ ЗНАЧЕНИЕ MIRAGE MIRAGE平均值
	CARATTERISTICHE DIMENSIONALI - SIZE CHARACTERISTICS - MASSEIGENSCHAFTEN DETERMINATION DES CARACTERISTIQUES DIMENSIONNELLES - CARACTERÍSTICAS DIMENSIONALES - РАЗМЕРНЫЕ ХАРАКТЕРИСТИКИ - 尺寸特征			NAT
	LATI SIDES - SEITEN COTES - CANTOS РАЗМЕРЫ СТОРОН - 側邊	EN ISO 10545-2	± 0,3% MAX (± 1,0 mm MAX)	CONFORME COMPLYING
	SPESSORE THICKNESS - DICKE EPAISSEUR - ESPESOR ТОЛЩИНА - 厚度	EN ISO 10545-2	± 5,0% MAX (± 0,5 mm MAX)	CONFORME COMPLYING
	RETTILINEITÀ DEGLI SPIGOLI STRAIGHTNESS OF SIDES - GERADLINIGKEIT DER KANTEN RECTITUDE DES ARETES - RECTITUD DE LOS CANTOS КОСОУГОЛЬНОСТЬ - 边角平直度	EN ISO 10545-2	± 0,3% MAX (± 0,8 mm MAX)	CONFORME COMPLYING
	ORTOGONALITÀ RECTANGULARITY - RECHTWINKLIGKEIT PERPENDICULARITÉ - ORTOGONALIDAD КРИВИЗНА СТОРОН - 直角度	EN ISO 10545-2	± 0,3% MAX (± 1,5 mm MAX)	CONFORME COMPLYING
	PLANARITÀ SURFACE FLATNESS - EBENFLÄCHIGKEIT PLANEITE DE SURFACE - PLANEIDAD КРИВИЗНА ЛИЦЕВОЙ ПОВЕРХНОСТИ - 平整度	EN ISO 10545-2	± 0,4% MAX (± 1,8 mm MAX)	CONFORME COMPLYING
	ASSORBIMENTO D'ACQUA WATER ABSORPTION - WASSERAUFNAHME ABSORPTION D'EAU - ABSORCIÓN DE AGUA ВОДОПОГЛОЩЕНИЕ - 吸水率	EN ISO 10545-3	≤ 0,5%	≤ 0,1%
	RESISTENZA ALLA FLESSIONE FLEXION RESISTANCE - BIEGEFESTIGKEIT RESISTANCE A LA FLEXION - RESISTENCIA A LA FLEXIÓN ПРЕДЕЛ ПРОЧНОСТИ ПРИ ИЗГИБЕ - 抗弯强度	EN ISO 10545-4	S ≥ 700 N (< 7,5 mm) S ≥ 1.300 N (> 7,5 mm) R ≥ 35 N/mm².	≠ 20 mm: S≥12.500N R≥48 N/mm²
	RESISTENZA ALL'URTO IMPACT RESISTANCE - STOSSFESTIGKEIT RESISTANCE AUX CHOCS - RESISTENCIA A LOS GOLPES УДАРОСТОЙКОСТЬ - 抗冲击强度	EN ISO 10545-5	VALORE DICHIARATO DECLARED VALUE	> 0,48
	RESISTENZA ALL'ABRAZIONE ABRASION RESISTANCE - ABRIEFESTIGKEIT RESISTANCE A L'ABRASION - RESISTENCIA A LA ABRASIÓN СТОЙКОСТЬ К ИСТИРАНИЮ - 耐磨强度	EN ISO 10545-6	≤ 175 mm³	< 150 mm³
	COEFFICIENTE DI DILATAZIONE TERMICA LINEARE COEFFICIENT OF LINEAR THERMAL-EXPANSION - LINEARER WÄRMEAUDEHNUNGSKOEFFIZIENT COEFFICIENT DE DILATATION THERMIQUE LINEAIRE - COEFICIENTE DE DILATACIÓN TÉRMICA LINEAL КОЭФФИЦИЕНТ ЛИНЕЙНОГО ТЕРМИЧЕСКОГО РАСТЯЖЕНИЯ - 线性热膨胀系数	EN ISO 10545-8	-	α=6,0x10 ⁻⁶ °C ⁻¹
	RESISTENZA AGLI SBALZI TERMICI RESISTANCE TO THERMAL SHOCKS - BESTÄNDIGKEIT GEGEN TEMPERATURSCHWANKUNGEN RESISTANCE AUX CHOCS THERMIQUES - RESISTENCIA A LOS CHOQUES TÉRMICOS СТОЙКОСТЬ К ПЕРЕПАДАМ ТЕМПЕРАТУРЫ - 耐热突变性	EN ISO 10545-9	TEST SUPERATO SECONDO EN ISO 10545-1 PASS ACCORDING EN ISO 10545-1	NESSUN DANNO NO DAMAGE
	RESISTENZA AL GELO FROST RESISTANCE - FROSTBESTÄNDIGKEIT RESISTANCE AU GEL - RESISTENCIA AL HIELO МОРОЗОСТОЙКОСТЬ - 耐冻性	EN ISO 10545-12	TEST SUPERATO SECONDO EN ISO 10545-1 PASS ACCORDING EN ISO 10545-1	NESSUN DANNO NO DAMAGE
	RESISTENZA ALL'ATTACCO CHIMICO RESISTANCE TO CHEMICALS - CHEMIKALIENBESTÄNDIGKEIT RESISTANCE A L'ATTAQUE CHIMIQUE - RESISTENCIA QUÍMICA ХИМИЧЕСКАЯ СТОЙКОСТЬ - 耐化学作用	EN ISO 10545-13	UB MIN.	A LA HA
	RESISTENZA ALLE MACCHIE RESISTANCE TO STAINS - FLECKENBESTÄNDIGKEIT RESISTANCE AUX TACHES - RESISTENCIA A LAS MANCHAS УСТОЙЧИВОСТЬ К ПЯТНООБРАЗОВАНИЮ - 防污性	EN ISO 10545-14	VALORE DICHIARATO DECLARED VALUE	5
	CESSIONE DI PIOMBO E CADMIO LEAD AND CADMIUM DISCHARGE - ABGABE VON BLEI UND CADMIUM PERTE DE PLOMB ET CADMIUM - CESIÓN DE PLOMO Y CADMIO ВЫДЕЛЕНИЕ СВИНЦА И КАДМИЯ - 铅和镉的排放	EN ISO 10545-15	VALORE DICHIARATO DECLARED VALUE	< AL LIMITE DI RILEVAMENTO < THAN INSTRUMENT LIMIT
				RD 20mm
		DM 236/89 BCRA	> 0,40	> 0,40
		ANSI A326.3	Wet and Dry	≥ 0,55
		AS 4586	-	P3
		DIN 51130	-	R11
		DIN 51097	-	A+B
		UNE 41901	≥ CL1	CL3
		BS 7976 sl.96-4S	Wet and Dry	≥ 0,36
		BS 7976 sl.55-TRL	Wet and Dry	-
	SCIVOLOSITÀ SKID RESISTANCE - RUTSCHWERT GLISSANCE - ADHERENCIA СКОЛЬЗКОСТЬ - 防滑性			

Per i certificati specifici, contattare Mirage SpA - For specific certificates, please contact Mirage SpA - Für die speziellen Zertifikate wenden Sie sich bitte an Mirage SpA - Pour les certificats spécifiques, veuillez contacter Mirage SpA
Para los certificados específicos, contactar Mirage SpA - Для сертификатов обращайтесь в компанию Mirage SpA - 关于具体的证书, 请联系Mirage SpA公司



FLOOR: Daylight **NN 01** 200x1200 / 8"x48" Chevron NAT RECT

NOON

NooN perfectly interprets the **WORN** and **TEXTURAL** finish of wood.

The collection brings together the warmth and the elegance of natural wood, with all the outstanding technical features of Mirage® porcelain stoneware: wear resistance and durability.



FLOOR: Ember **NN 02** 200x1200 / 8"x48" NAT RECT



COLORI
Colours | Farben | Couleurs | Colores | Цветов | 种颜色



Daylight
NN 01



Ember
NN 02



Honey
NN 03



Burnet
NN 04



Charcoal
NN 05

OUTDOOR FLOOR: Ember **NN 02** 300x1200 / 12"x48" RD RECT EVO_2/E" 20 mm

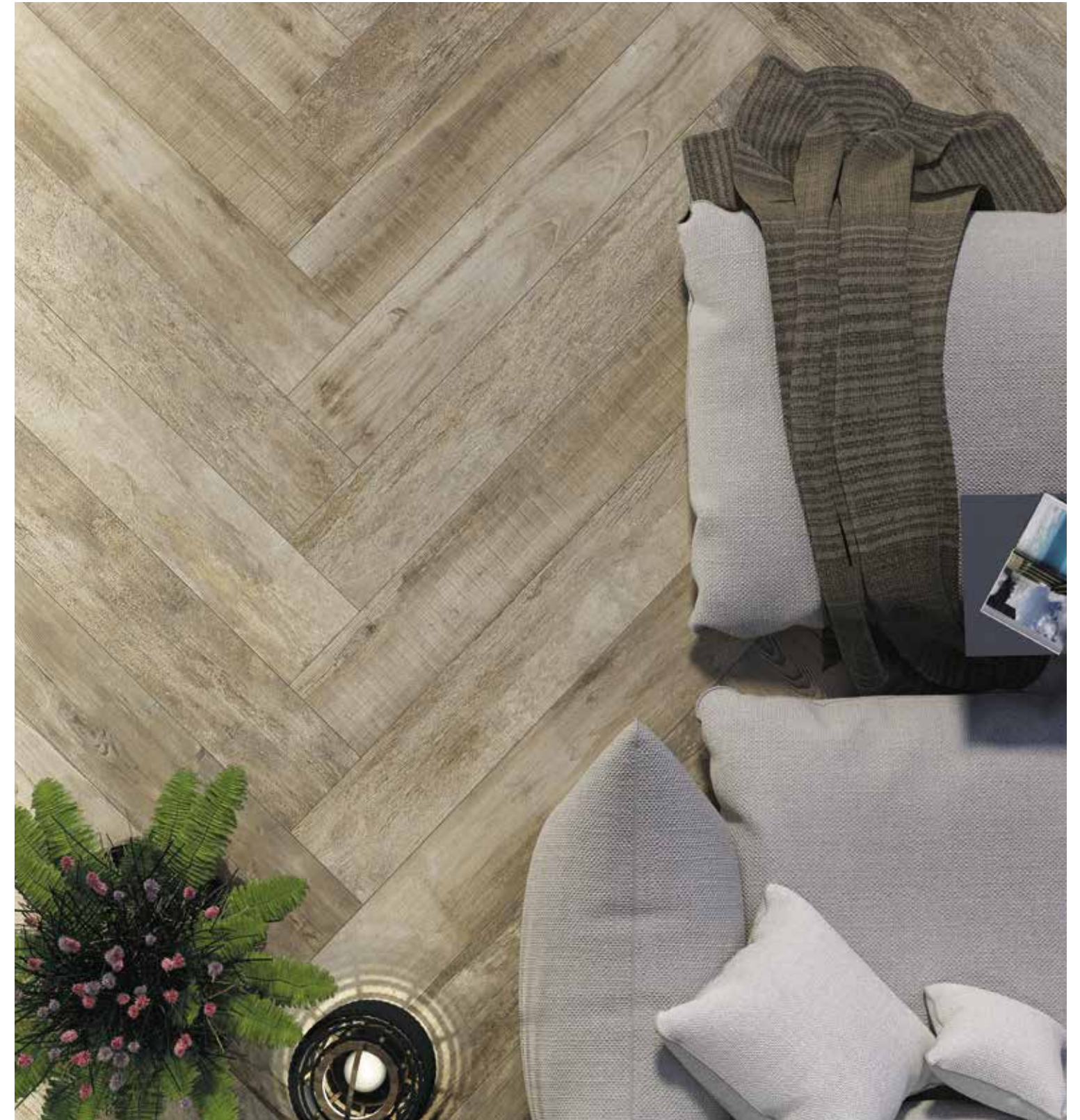

INDOOR FLOOR: Daylight **NN 01** 200x1200 / 8"x48" NAT RECT
OUTDOOR FLOOR: Ember **NN 02** 200x1200 / 8"x48" GP RECT R11

COLORI

Colours | Farben | Couleurs | Colores | Цветов | 种颜色

DAYLIGHT NN 01



	Formati Nominali Nominal Sizes	Superficie Finish	Spessore mm Thickness mm
	200x1200 / 8"x48"	NAT / GP RECT	9
	Chevron 200x1200 / 8"x48"	NAT RECT	9
	300x1200 / 12"x48"	RD RECT	20
	Stucchi consigliati Recommended grouts		
	KERAKOLL 06		
	MAPEI 110 Manhattan		
	LATICRETE 89 Smoke Grey		

EMBER NN 02



	Formati Nominali Nominal Sizes	Superficie Finish	Spessore mm Thickness mm
	200x1200 / 8"x48"	NAT / GP RECT	9
	Chevron 200x1200 / 8"x48"	NAT RECT	9
	300x1200 / 12"x48"	RD RECT	20
	Stucchi consigliati Recommended grouts		
	KERAKOLL 08		
	MAPEI 112 Grigio Medio		
	LATICRETE 78 Sterling Silver		

HONEY NN 03



	Formati Nominali Nominal Sizes	Superficie Finish	Spessore mm Thickness mm
	200x1200 / 8"x48"	NAT / GP RECT	9
	Chevron 200x1200 / 8"x48"	NAT RECT	9
	300x1200 / 12"x48"	RD RECT	20
	Stucchi consigliati Recommended grouts		
	KERAKOLL 09		
	MAPEI 113 Grigio Cemento		
	LATICRETE 34 Sand Stone		

BURNET NN 04



	Formati Nominali Nominal Sizes	Superficie Finish	Spessore mm Thickness mm
	200x1200 / 8"x48"	NAT / GP RECT	9
	Chevron 200x1200 / 8"x48"	NAT RECT	9
	Stucchi consigliati Recommended grouts		
	KERAKOLL 11		
	MAPEI 114 Antracite		
	LATICRETE 45 Raven		

CHARCOAL NN 05



	Formati Nominali Nominal Sizes	Superficie Finish	Spessore mm Thickness mm
	200x1200 / 8"x48"	NAT / GP RECT	9
	Chevron 200x1200 / 8"x48"	NAT RECT	9
	Stucchi consigliati Recommended grouts		
	KERAKOLL 11		
	MAPEI 114 Antracite		
	LATICRETE 45 Raven		

RIASSUNTIVO FORMATI ED IMBALLI

Summary of sizes and packaging | Übersicht über Formate und Verpackungen | Récapitulatif formats et emballages
Sinóptico de formatos y embalajes | Краткая информация о форматах и упаковках | 规格和包装概述

Formati Nominali Nominal Sizes		Chevron 200x1200 8"x48"	200x1200 8"x48"
Tutti i formati sono rettificati. All sizes are rectified.			
Superficie Finish		NAT	GP
DAYLIGHT NN 01	V4	■	■
EMBER NN 02	V4	■	■
HONEY NN 03	V3	■	■
BURNET NN 04	V3	■	■
CHARCOAL NN 05	V4	■	■
Peso lordo per scatola Gross weight per box		17,50	30,24
Pezzi per scatola Pieces for box		4	6
mq. scatola sqm. box		0,80	1,44
Scatole / Full pallet boxes / Full pallet		40	32
mq. pallet sqm. pallet		32,00	46,08

Formati Nominali Nominal Sizes		300x1200 12"x48"
Tutti i formati sono rettificati. All sizes are rectified.		
Superficie Finish		RD
DAYLIGHT NN 01	V4	■
EMBER NN 02	V4	■
HONEY NN 03	V3	■
Peso lordo per scatola Gross weight per box		31,25
Pezzi per scatola Pieces for box		2
mq. scatola sqm. box		0,72
Scatole / Full pallet boxes / Full pallet		36
mq. pallet sqm. pallet		25,92

NAT: Naturale | Natural | Natur/unpoliert | Naturelle | Natural | Натуральный | 天然
RD: Radiale
GP: Grip

PEZZI SPECIALI

Special pieces | Sonderstücke | Pièces spéciales | Piezas especiales | специальные изделия | 特殊件

	Battiscopa* 72x600 27/8"x24"	Gradino A* 330x1200 13 1/8"x48"	Unico 2.0 300x600x20 12"x24"x3/4"
Pezzi speciali Special pieces			
Superficie Finish	NAT	NAT	RD
DAYLIGHT NN 01	■	■	■
EMBER NN 02	■	■	■
HONEY NN 03	■	■	■
BURNET NN 04	■	■	-
CHARCOAL NN 05	■	■	-
Pezzi per scatola Pieces for box	10	4	3

* Finitura a becco di civetta | One-round edge shaping | Ausführung mit Eckabrundung | Façonnage à bord rond | Acabado canto romo | Плитка с завалом | 鹰嘴边缘处理

MY NOTES

.....

.....

.....

.....

.....

Maggiori informazioni
More information





CARATTERISTICHE TECNICHE

Technical specifications | Technische Eigenschaften | Caractéristiques techniques | Características técnicas | Технические характеристики | 技术特征

STANDARD EN 14411 - G

CARATTERISTICHE TECNICHE TECHNICAL DATA TECHNISCHE DATEN CARACTERISTIQUES TECHNIQUES CARACTERÍSTICAS TÉCNICAS ТЕХНИЧЕСКИЕ ХАРАКТЕРИСТИКИ 技术特征		NORMA STANDARD NORM NORME NORMA ЗНАЧЕНИЯ 标准	VALORI PRESCRITTI DALLE NORME EN 14411 - G INTERNATIONAL STANDARDS EN 14411 - G INTERNATIONALE NORMWERTE EN 14411 - G VALEURS PREVUES PAR LES NORMES EN 14411 - G VALORES PREVISTOS POR LAS NORMAS EN 14411 - G ПРЕДУСМОТРЕННЫЕ СТАНДАРТОМ EN 14411-G EN 14411 - G标准规定值	*VALORE MEDIO MIRAGE MIRAGE AVERAGE VALUE MIRAGE MITTELWERT VALEURS MOYEN MIRAGE VALOR MEDIO MIRAGE СРЕДНЕЕ ЗНАЧЕНИЕ MIRAGE MIRAGE平均值		
CARATTERISTICHE DIMENSIONALI - SIZE CHARACTERISTICS - MASSEIGENSCHAFTEN DETERMINATION DES CARACTERISTIQUES DIMENSIONELLES - CARACTERÍSTICAS DIMENSIONALES - РАЗМЕРНЫЕ ХАРАКТЕРИСТИКИ - 尺寸特征				NAT	GP	RD
LATI SIDES - SEITEN COTES - CANTOS РАЗМЕРЫ СТОРОН - 侧边	EN ISO 10545-2	± 0,3% MAX (± 1,0 mm MAX)	CONFORME COMPLYING			
SPESORE THICKNESS - DICKE EPAISSEUR - ESPESOR ТОЛЩИНА - 厚度	EN ISO 10545-2	± 5,0% MAX (± 0,5 mm MAX)	CONFORME COMPLYING			
RETTILINEITÀ DEGLI SPIGOLI STRAIGHTNESS OF SIDES - GERÄDLINIGKEIT DER KANTEN RECTITUDE DES ARETES - RECTITUD DE LOS CANTOS КОСОУГОЛЬНОСТЬ - 边角平直度	EN ISO 10545-2	± 0,3% MAX (± 0,8 mm MAX)	CONFORME COMPLYING			
ORTOGONALITÀ RECTANGULARITY - RECHTWINKLIGKEIT PERPENDICULARITÉ - ORTOGONALIDAD КРИВИЗНА СТОРОН - 直角度	EN ISO 10545-2	± 0,3% MAX (± 1,5 mm MAX)	CONFORME COMPLYING			
PLANARITÀ SURFACE FLATNESS - EBENFLÄCHIGKEIT PLANEITE DE SURFACE - PLANEIDAD КРИВИЗНА ЛИЦЕВОЙ ПОВЕРХНОСТИ - 平整度	EN ISO 10545-2	± 0,4% MAX (± 1,8 mm MAX)	CONFORME COMPLYING			
ASSORBIMENTO D'ACQUA WATER ABSORPTION - WASSERAUFNAHME ABSORPTION D'EAU - ABSORCIÓN DE AGUA ВОДОПОГЛОЩЕНИЕ - 吸水率	EN ISO 10545-3	≤ 0,5%	≤ 0,1%			
RESISTENZA ALLA FLESSIONE FLEXION RESISTANCE - BIEGEFESTIGKEIT RESISTANCE A LA FLEXION - RESISTENCIA A LA FLEXIÓN ПРЕДЕЛ ПРОЧНОСТИ ПРИ ИЗГИБЕ - 抗弯强度	EN ISO 10545-4	S ≥ 700 N (< 7,5 mm) S ≥ 1.300 N (> 7,5 mm) R ≥ 35 N/mm ² .	≠ 9 mm: S ≥ 2.400 N R ≥ 48 N/mm ² ≠ 20 mm: S ≥ 12.500 N R ≥ 48 N/mm ²			
RESISTENZA ALL'URTO IMPACT RESISTANCE - STOSSFESTIGKEIT RESISTANCE AUX CHOCS - RESISTENCIA A LOS GOLPES УДАРОСТОЙКОСТЬ - 抗冲击强度	EN ISO 10545-5	VALORE DICHIARATO DECLARED VALUE	> 0,80			
COEFFICIENTE DI DILATAZIONE TERMICA LINEARE COEFFICIENT OF LINEAR THERMAL-EXPANSION - LINEARER WÄRMEAUDEHNUNGSKOEFFIZIENT COEFFICIENT DE DILATATION THERMIQUE LINEAIRE - COEFICIENTE DE DILATACIÓN TÉRMICA LINEAL КОЭФФИЦИЕНТ ЛИНЕЙНОГО ТЕРМИЧЕСКОГО РАСТЯЖЕНИЯ - 线性热膨胀系数	EN ISO 10545-8	—	α=6,2x10 ⁻⁶ °C ⁻¹			
RESISTENZA AGLI SBALZI TERMICI RESISTANCE TO THERMAL SHOCKS - BESTÄNDIGKEIT GEGEN TEMPERATURSCHWANKUNGEN RESISTANCE AUX CHOCS THERMIQUES - RESISTENCIA A LOS CHOQUES TÉRMICOS СТОЙКОСТЬ К ПЕРЕПАДАМ ТЕМПЕРАТУРЫ - 耐热突变性	EN ISO 10545-9	TEST SUPERATO SECONDO EN ISO 10545-1 PASS ACCORDING EN ISO 10545-1	NESSUN DANNO NO DAMAGE			
RESISTENZA AL GELO FROST RESISTANCE - FROSTBESTÄNDIGKEIT RESISTANCE AU GEL - RESISTENCIA AL HIELO МОРОЗОСТОЙКОСТЬ - 耐冻性	EN ISO 10545-12	TEST SUPERATO SECONDO EN ISO 10545-1 PASS ACCORDING EN ISO 10545-1	NESSUN DANNO NO DAMAGE			
RESISTENZA ALL'ATTACCO CHIMICO RESISTANCE TO CHEMICALS - CHEMIKALIENBESTÄNDIGKEIT RESISTANCE A L'ATTAQUE CHIMIQUE - RESISTENCIA QUÍMICA ХИМИЧЕСКАЯ СТОЙКОСТЬ - 耐化学品作用	EN ISO 10545-13	UB MIN.	A LA HA			
RESISTENZA ALLE MACCHIE RESISTANCE TO STAINS - FLECKENBESTÄNDIGKEIT RESISTANCE AUX TACHES - RESISTENCIA A LAS MANCHAS УСТОЙЧИВОСТЬ К ПЯТНООБРАЗОВАНИЮ - 防污性	EN ISO 10545-14	VALORE DICHIARATO DECLARED VALUE	5	-	5	
				NAT	GP	RD 20mm
	DM 236/89 BCRA	> 0,40	> 0,40	> 0,40	> 0,40	> 0,40
	ANSI A326.3	Wet and Dry	≥ 0,42	≥ 0,55	≥ 0,55	≥ 0,55
	AS 4586	-	P2	P4	P5	P5
	DIN 51130	-	R10	R11	R11	R11
	DIN 51097	-	A	A+B+C	A+B	A+B
	UNE 41901	≥ CL1	CL1	CL3	CL3	CL3
	BS 7976 sl.96-4S	Wet and Dry	≥ 0,36	≥ 0,36	≥ 0,36	≥ 0,36
	BS 7976 sl.55-TRL	Wet and Dry	-	≥ 0,36	≥ 0,36	≥ 0,36
SCIVOLOSITÀ SKID RESISTANCE - RUTSCHWERT GLISSANCE - ADHERENCIA СКОЛЬЗКОСТЬ - 防滑性						

Per i certificati specifici, contattare Mirage SpA - For specific certificates, please contact Mirage SpA - Für die speziellen Zertifikate wenden Sie sich bitte an Mirage SpA - Pour les certificats spécifiques, veuillez contacter Mirage SpA - Para los certificados específicos, contactar Mirage SpA - Для сертификатов обращайтесь в компанию Mirage SpA - 关于具体的证书, 请联系Mirage SpA公司



FLOOR: Farge **RR 05** 1200x1200 / 48"x48" NAT RECT
WALL: Farge **RR 05** 1200x2780 / 48"x110" NAT RECT
FURNITURE: BATHMOOD Joy **RR 05** SP **CL 05** SP

NORR

Essential colour range with a sophisticated appearance, for a **NORDIC INSPIRED** design.

Norr is a collection marked by a harmoniously irregular grain, where pebbles with different colours and sizes create attractive three-dimensional effects.



OUTDOOR FLOOR: Hav **RR 06** 800x800 / 31½"x31½" ST RECT EVO_2/E" ± 20 mm



COLORI

Colours | Farben | Couleurs | Colores | Цветов | 种颜色

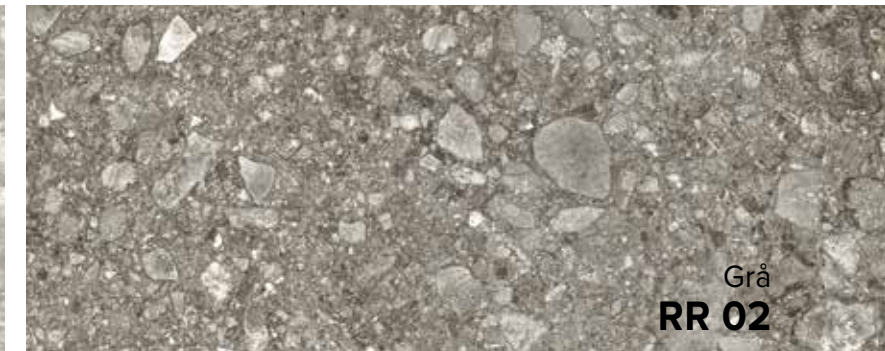
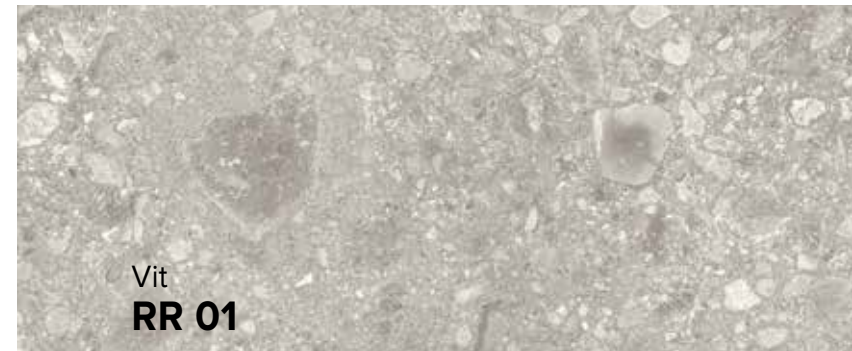

FLOOR Grå **RR 02** 600x1200 / 24"x48" NAT RECT
WALL Grå **RR 02** 1200x2780 / 48"x110" NAT RECT
WORKTOPS and WASHBASIN Grå **RR 02** NAT



FLOOR: Grus **RR 09** 800x800 / 31½"x31½" NAT RECT
WALL: Grus **RR 09** 1200x2780 / 48"x110" NAT RECT
COUNTER: Grus **RR 09** NAT



FLOOR Farge **RR 05** 1200x1200 / 48"x48" NAT RECT
WALL: Farge **RR 05** 1200x2780 / 48"x110" NAT RECT
BENCHS and FLOWER BOXES: Farge **RR 05** NAT



FLOOR: Öken **RR 08** 1200x1200 / 48"x48" NAT RECT
WALL: Öken **RR 08** 1200x2780 / 48"x110" NAT RECT

COLORI

Colours | Farben | Couleurs | Colores | Цветов | 种颜色

VIT RR 01

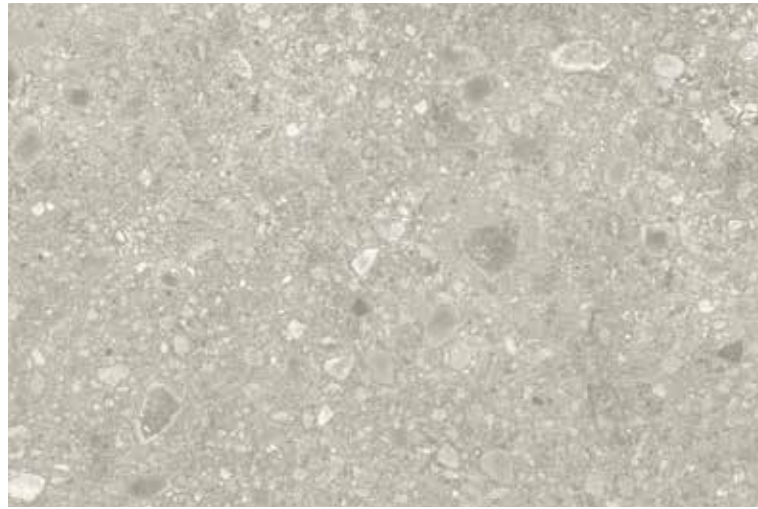

Formati Nominali Nominal Sizes	Superficie Finish	Spessore mm Thickness mm
150x600 / 6"x24"	NAT RECT	9
300x600 / 12"x24"	NAT RECT	9
600x600 / 24"x24"	NAT / ST RECT	9
800x800 / 31½"x31½"	NAT RECT	9
600x1200 / 24"x48"	NAT RECT	9
1200x1200 / 48"x48"	NAT RECT	9
600x600 / 24"x24"	ST RECT	20
800x800 / 31½"x31½"	ST RECT	20
1200x1200 / 48"x48"	ST RECT	20

Stucchi consigliati Recommended grouts		
KERAKOLL	06	
MAPEI	110 Manhattan 2000	
LATICRETE	88 Silver Shadow	

MELK RR 04



Formati Nominali Nominal Sizes	Superficie Finish	Spessore mm Thickness mm
150x600 / 6"x24"	NAT RECT	9
300x600 / 12"x24"	NAT RECT	9
600x600 / 24"x24"	NAT / ST RECT	9
800x800 / 31½"x31½"	NAT RECT	9
600x1200 / 24"x48"	NAT RECT	9
1200x1200 / 48"x48"	NAT RECT	9

Stucchi consigliati Recommended grouts		
KERAKOLL	20	
MAPEI	111 Grigio Argento	
LATICRETE	88 Silver Shadow	

GRÅ RR 02



Formati Nominali Nominal Sizes	Superficie Finish	Spessore mm Thickness mm
150x600 / 6"x24"	NAT RECT	9
300x600 / 12"x24"	NAT RECT	9
600x600 / 24"x24"	NAT / ST RECT	9
800x800 / 31½"x31½"	NAT RECT	9
600x1200 / 24"x48"	NAT RECT	9
1200x1200 / 48"x48"	NAT RECT	9
600x1200 / 24"x48"	NAT RECT	6
1200x1200 / 48"x48"	NAT RECT	6
1200x2780 / 48"x110"	NAT RECT	6
1600x1600 / 63"x63"	NAT RECT	6
1600x3200 / 63"x126"	NAT RECT	6
1620x3240 / 63¾"x127½"	SP NOT RECT	12
600x600 / 24"x24"	ST RECT	20
800x800 / 31½"x31½"	ST RECT	20
1200x1200 / 48"x48"	ST RECT	20

Stucchi consigliati Recommended grouts		
KERAKOLL	08	
MAPEI	112 Grigio Medio	
LATICRETE	78 Sterling Silver	

FARGE RR 05



Formati Nominali Nominal Sizes	Superficie Finish	Spessore mm Thickness mm
150x600 / 6"x24"	NAT RECT	9
300x600 / 12"x24"	NAT RECT	9
600x600 / 24"x24"	NAT / ST RECT	9
800x800 / 31½"x31½"	NAT RECT	9
600x1200 / 24"x48"	NAT RECT	9
1200x1200 / 48"x48"	NAT RECT	9
600x1200 / 24"x48"	NAT RECT	6
1200x1200 / 48"x48"	NAT RECT	6
1200x2780 / 48"x110"	NAT RECT	6
1620x3240 / 63¾"x127½"	SP NOT RECT	12
600x600 / 24"x24"	ST RECT	20
800x800 / 31½"x31½"	ST RECT	20
1200x1200 / 48"x48"	ST RECT	20

Stucchi consigliati Recommended grouts		
KERAKOLL	08	
MAPEI	113 Grigio Cemento	
LATICRETE	78 Sterling Silver	

SVART RR 03

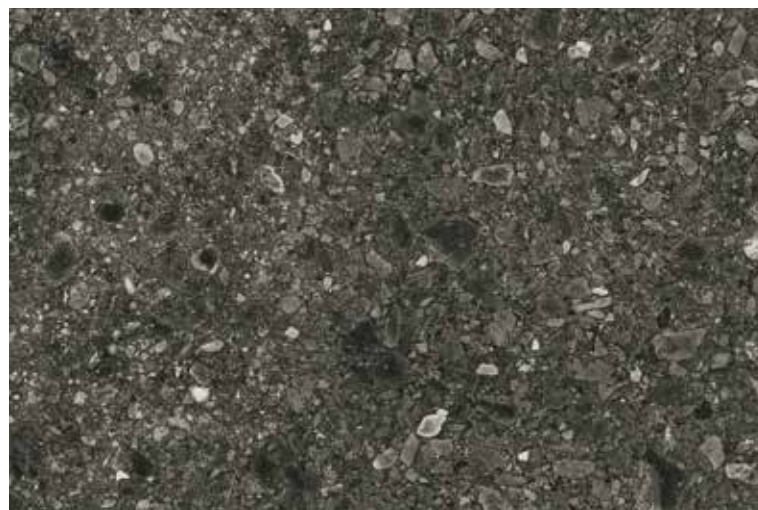

Formati Nominali Nominal Sizes	Superficie Finish	Spessore mm Thickness mm
150x600 / 6"x24"	NAT RECT	9
300x600 / 12"x24"	NAT RECT	9
600x600 / 24"x24"	NAT / ST RECT	9
800x800 / 31½"x31½"	NAT RECT	9
600x1200 / 24"x48"	NAT RECT	9
1200x1200 / 48"x48"	NAT RECT	9
600x600 / 24"x24"	ST RECT	20
800x800 / 31½"x31½"	ST RECT	20
1200x1200 / 48"x48"	ST RECT	20

Stucchi consigliati Recommended grouts		
KERAKOLL	11	
MAPEI	114 Antracite	
LATICRETE	45 Raven	

HAV RR 06



Formati Nominali Nominal Sizes	Superficie Finish	Spessore mm Thickness mm
150x600 / 6"x24"	NAT RECT	9
300x600 / 12"x24"	NAT RECT	9
600x600 / 24"x24"	NAT / ST RECT	9
800x800 / 31½"x31½"	NAT RECT	9
600x1200 / 24"x48"	NAT RECT	9
1200x1200 / 48"x48"	NAT RECT	9
1200x2780 / 48"x110"	NAT RECT	6
600x600 / 24"x24"	ST RECT	20
800x800 / 31½"x31½"	ST RECT	20

Stucchi consigliati Recommended grouts		
KERAKOLL	07	
MAPEI	111 Grigio Argento	
LATICRETE	89 Smoke Grey	

COLORI

Colours | Farben | Couleurs | Colores | Цветов | 种颜色

ÖKEN RR 08



Formati Nominali Nominal Sizes	Superficie Finish	Spessore mm Thickness mm
150x600 / 6"x24"	NAT RECT	9
300x600 / 12"x24"	NAT RECT	9
600x600 / 24"x24"	NAT / ST RECT	9
800x800 / 31½"x31½"	NAT RECT	9
600x1200 / 24"x48"	NAT RECT	9
1200x1200 / 48"x48"	NAT RECT	9
1200x2780 / 48"x110"	NAT RECT	6
600x600 / 24"x24"	ST RECT	20
800x800 / 31½"x31½"	ST RECT	20

Stucchi consigliati Recommended grouts		
KERAKOLL	44	
MAPEI	133 Sabbia	
LATICRETE	17 Marble Geige	

GRUS RR 09

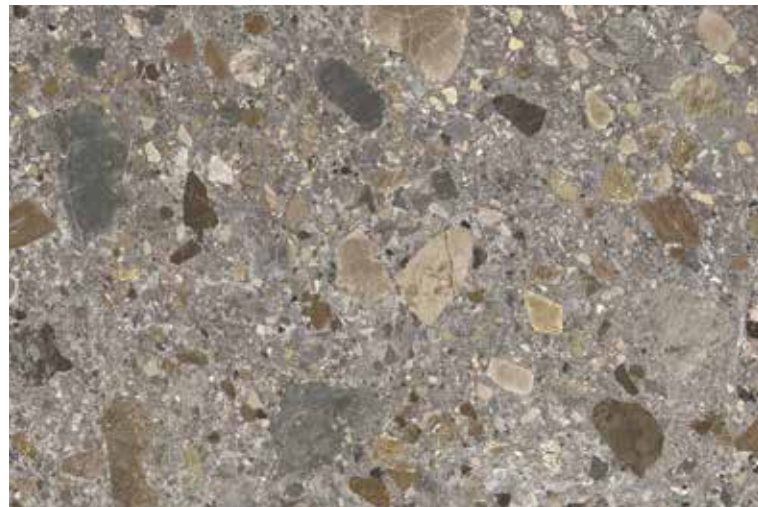

Formati Nominali Nominal Sizes	Superficie Finish	Spessore mm Thickness mm
150x600 / 6"x24"	NAT RECT	9
300x600 / 12"x24"	NAT RECT	9
600x600 / 24"x24"	NAT / ST RECT	9
800x800 / 31½"x31½"	NAT RECT	9
600x1200 / 24"x48"	NAT RECT	9
1200x1200 / 48"x48"	NAT RECT	9
1200x2780 / 48"x110"	NAT RECT	6
600x600 / 24"x24"	ST RECT	20
800x800 / 31½"x31½"	ST RECT	20

Stucchi consigliati Recommended grouts		
KERAKOLL	06	
MAPEI	112 Grigio Medio	
LATICRETE	78 Sterling Silver	



WALL: Hav RR 06 1200x2780 / 48"x110" NAT RECT
FLOOR: Hav RR 06 1200x1200 / 48"x48" NAT RECT

RIASSUNTIVO FORMATI ED IMBALLI

Summary of sizes and packaging | Übersicht über Formate und Verpackungen | Récapitulatif formats et emballages
Sinóptico de formatos y embalajes | Краткая информация о форматах и упаковках | 规格和包装概述

		9 mm					
Formati Nominali Nominal Sizes		150x600 6"x24"	300x600 12"x24"	600x600 24"x24"	800x800 31½"x31½"	600x1200 24"x48"	1200x1200 48"x48"
Tutti i formati sono rettificati. All sizes are rectified.							
Superficie Finish		NAT	NAT	NAT	ST	NAT	NAT
VIT RR 01	V2	■	■	■	■	■	■
GRÀ RR 02	V2	■	■	■	■	■	■
SVART RR 03	V2	■	■	■	■	■	■
MELK RR 04	V2	■	■	■	■	■	■
FARGE RR 05	V2	■	■	■	■	■	■
HAV RR 06	V2	■	■	■	■	■	■
ÖKEN RR 08	V2	■	■	■	■	■	■
GRUS RR 09	V2	■	■	■	■	■	■
Peso lordo per scatola Gross weight per box		26,92	26,15	22,16	22,16	27,36	30,00
Pezzi per scatola Pieces for box		14	7	3	3	2	2
mq. scatola sqm. box		1,26	1,26	1,08	1,08	1,28	1,44
Scatole / Full pallet boxes / Full pallet		40	40	40	40	48	35
mq. pallet sqm. pallet		50,40	50,40	43,20	43,20	61,44	57,60

RIASSUNTIVO FORMATI ED IMBALLI

Summary of sizes and packaging | Übersicht über Formate und Verpackungen | Récapitulatif formats et emballages
Sinóptico de formatos y embalajes | Краткая информация о форматах и упаковках | 规格和包装概述

		20 mm		
Formati Nominali Nominal Sizes		600x600 24"x24"	800x800 31½"x31½"	1200x1200 48"x48"
Tutti i formati sono rettificati. All sizes are rectified.				
Superficie Finish		ST	ST	ST
VIT RR 01	V2	■	■	■
GRÀ RR 02	V2	■	■	■
SVART RR 03	V2	■	■	■
FARGE RR 05	V2	■	■	■
HAV RR 06	V2	■	■	-
ÖKEN RR 08	V2	■	■	-
GRUS RR 09	V2	■	■	-
Peso lordo per scatola Gross weight per box		31,14	28,50	Please refer to page 588
Pezzi per scatola Pieces for box		2	1	
mq. scatola sqm. box		0,72	0,64	
Scatole / Full pallet boxes / Full pallet		30	42	
mq. pallet sqm. pallet		21,60	26,88	

		6 mm				12 mm	
Formati Nominali Nominal Sizes		600x1200 24"x48"	1200x1200 48"x48"	1200x2780 48"x110"	1600x1600 63"x63"	1600x3200 63"x126"	1620x3240 63¾"x127½"
Tutti i formati sono rettificati, eccetto il formato 1620x3240. All sizes except 1620x3240 are rectified.							
Superficie Finish		NAT	NAT	NAT	NAT	NAT	SP
GRÀ RR 02	V2	■	■	■	■	■	■
FARGE RR 05	V2	■	■	■	-	-	■
HAV RR 06	V2	-	-	■	-	-	-
ÖKEN RR 08	V2	-	-	■	-	-	-
GRUS RR 09	V2	-	-	■	-	-	-
Peso lordo per scatola Gross weight per box		-	41,44	Please refer to page 588	Please refer to page 588	Please refer to page 588	Please refer to page 588
Pezzi per scatola Pieces for box		2	2				
mq. scatola sqm. box		1,44	2,88				
Scatole / Full pallet boxes / Full pallet		35	20				
mq. pallet sqm. pallet		50,40	57,60				

Per tutti i grandi formati è possibile prevedere, su richiesta, e con un lotto minimo l'applicazione di una stuoia in fibra di vetro.
For big sizes, a fibreglass mat can be applied on request, with a minimum production batch.

Per garantire elevati standard di sicurezza e le migliori performance tecniche in relazione al loro utilizzo finale (piani cucina, top, arredi), tutte le lastre in formato 1620x3240 in spessore 12mm prevedono l'applicazione di una stuoia in fibra di vetro sul retro della lastra.
All the 1620x3240 slabs in 12mm thickness are provided with a fibreglass mat applied to the back of the slab, to guarantee substantial safety standards and suitable technical performance required for their final use (kitchen countertops, tops, furnishings).

ACCORGIMENTI SPECIFICI PER L'APPLICAZIONE DELLE GRANDI LASTRE IN 6 MM DI SPESSORE: p. 582 | Precautions for 6mm big slabs applications: page 582 | spezifische Anweisungen zur Nutzung der Grossformate in 6mm: seite 582 | Precauciones específicas para la aplicación de las grandes placas en 6 mm de espesor: page 582 | Precautions spécifiques pour la pose des grandes plaques en 6mm d'épaisseur: página 582 | специальные предосторожности для укладки больших плит толщиной 6 мм : страница 582

RACCOMANDAZIONI PER UTILIZZO E CURA DELLE LASTRE COUNTERTOPS p. 583 | How to use and take good care of the COUNTERTOPS slabs p. 583 | Tipps für den Einsatz und die Pflege der Platten COUNTERTOPS p. 583 | Recommendations pour l'utilisation et le soin des plaques COUNTERTOPS p.583 | Recomendaciones para el uso y cuidado de las placas COUNTERTOPS p. 583 | Рекомендации по использованию и уходу за плитami COUNTERTOPS p.583 | 规格的COUNTERTOPS系列陶瓷板的使用和护理建议 583

MY NOTES

.....

.....

.....

.....

.....



















Maggiori informazioni
More information



NAT: Naturale | Natural | Natur/unpoliert | Naturelle | Natural | Натуральный | 天然
SP: Strutturata | Structured | Strukturiert | Structuré | Estructurado | Труктурированный | 结构
SP: Spazzolata

PEZZI SPECIALI

Special pieces | Sonderstücke | Pièces spéciales | Piezas especiales | специальные изделия | 特殊件

	 Battiscopa*	 Gradino A*	 Gradino A'	 Gradino B ang.	 Gradino B	 Gradino B	 Gradino G
 Pezzi speciali Special pieces	72x600 27/8"x24"	300x600 12"x24"	330x1200 13 1/8"x48"	330x330 13 1/8"x13 1/8"	330x600 13 1/8"x24"	330x1200 13 1/8"x48"	300x600 12"x24"
 Superficie Finish	NAT	NAT	NAT	NAT	NAT	NAT	NAT
 VIT RR 01	■	■	■	■	■	■	■
 GRÅ RR 02	■	■	■	■	■	■	■
 SVART RR 03	■	■	■	■	■	■	■
 MELK RR 04	■	■	■	■	■	■	■
 FARGE RR 05	■	■	■	■	■	■	■
 HAV RR 06	■	■	■	■	■	■	■
 ÖKEN RR 08	■	■	■	■	■	■	■
 GRUS RR 09	■	■	■	■	■	■	■
 Pezzi per scatola Pieces for box	10	7	4	4	4	2	7

* Finitura a becco di civetta | One-round edge shaping | Ausführung mit Eckabrundung | Façonnage à bord rond | Acabado canto romo | Плитка с завалом | 鹰嘴边缘处理

DECORI

Decors | Dekore | Decors | Decoros | Декоры | 装饰砖

 **Patchy NAT**
400x347 / 15 3/4"x13 5/8"



	 Pezzi per scatola Pieces for box
Mattoncino	6
Mosaico 36T	6
Portnoy	6
Patchy	6

NAT: Naturale | Natural | Natur/unpoliert | Naturelle | Natural | Натуральный | 天然

DECORI

Decors | Dekore | Decors | Decoros | Декоры | 装饰砖

 **Mattoncino NAT**
300x300 / 12"x12"
Tessere 24x48 / 1"x2"

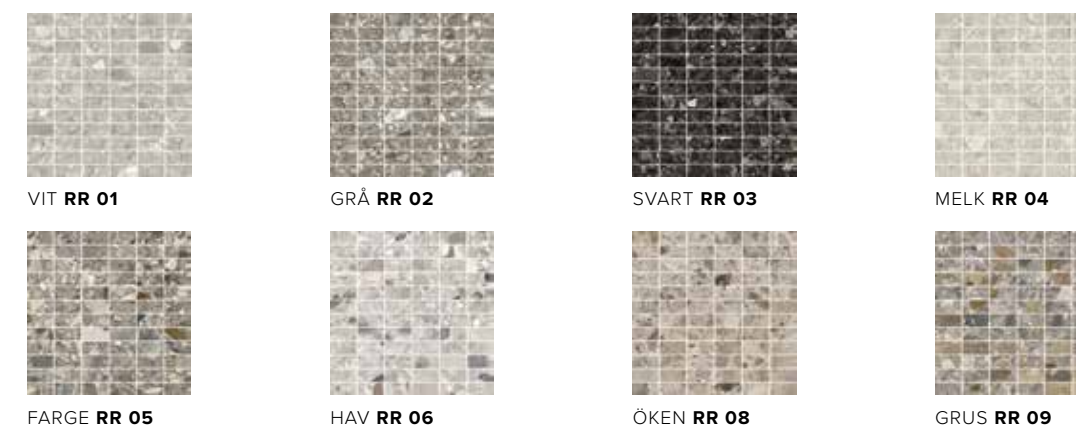

 **Mosaico 36T NAT**
300x300 / 12"x12"
Tessere 48x48 / 2"x2"

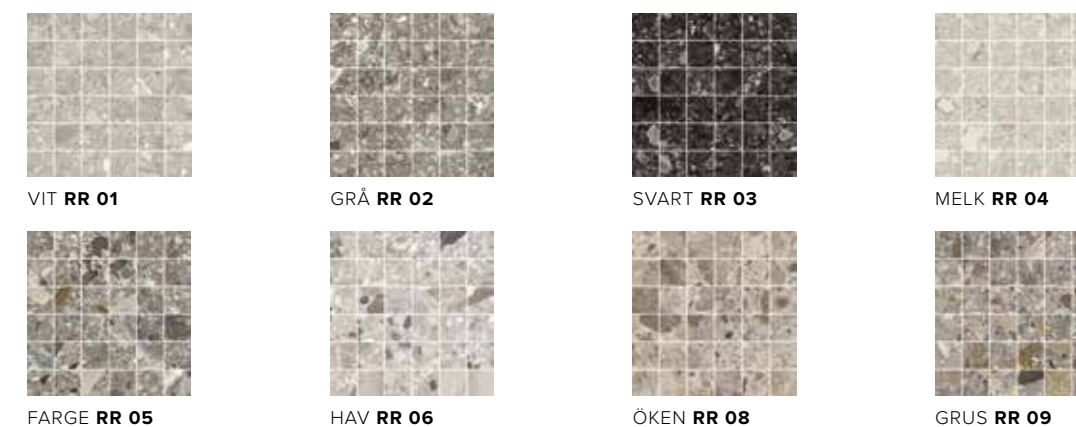

 **Portnoy NAT**
300x300 / 12"x12"



MATTONCINO, MOSAICO 36T, PORTNOY, PATCHY:
Decoro su rete | Mesh-backed decoration | Dekor auf netz | Décor sur filet | Decoración en red | Декор в сету | 网板背帖装饰件



FLOOR: Melk **RR 04** 600x1200 / 24"x48" NAT RECT
 WALL: Melk **RR 04** 300x600 / 12"x24" - 150x600 / 6"x24" NAT RECT

CARATTERISTICHE TECNICHE

Technical specifications | Technische Eigenschaften | Caractéristiques techniques | Características técnicas | Технические характеристики | 技术特征

STANDARD EN 14411 - G

	CARATTERISTICHE TECNICHE TECHNICAL DATA TECHNISCHE DATEN CARACTERISTIQUES TECHNIQUES CARACTERÍSTICAS TÉCNICAS ТЕХНИЧЕСКИЕ ХАРАКТЕРИСТИКИ 技术特征	NORMA STANDARD NORM NORME NORMA ЗНАЧЕНИЯ 标准	VALORI PRESCRITTI DALLE NORME EN 14411 - G INTERNATIONAL STANDARDS EN 14411 - G INTERNATIONALE NORMWERTE EN 14411 - G VALEURS PREVUES PAR LES NORMES EN 14411 - G VALORES PREVISTOS POR LAS NORMAS EN 14411 - G ПРЕДУСМОТРЕННЫЕ СТАНДАРТОВ EN 14411-G EN 14411 - G标准规定值	*VALORE MEDIO MIRAGE MIRAGE AVERAGE VALUE MIRAGE MITTELWERT VALEURS MOYEN MIRAGE VALOR MEDIO MIRAGE СРЕДНЕЕ ЗНАЧЕНИЕ MIRAGE MIRAGE平均值
	CARATTERISTICHE DIMENSIONALI - SIZE CHARACTERISTICS - MASSEIGENSCHAFTEN DETERMINATION DES CARACTERISTIQUES DIMENSIONNELLES - CARACTERÍSTICAS DIMENSIONALES - РАЗМЕРНЫЕ ХАРАКТЕРИСТИКИ - 尺寸特征			
	LATI SIDES - SEITEN COTES - CANTOS РАЗМЕРЫ СТОРОН - 側邊	EN ISO 10545-2	± 0,3% MAX (± 1,0 mm MAX)	CONFORME COMPLYING
	SPESORE THICKNESS - DICKE EPAISSEUR - ESPESOR ТОЛЩИНА - 厚度	EN ISO 10545-2	± 5,0% MAX (± 0,5 mm MAX)	CONFORME COMPLYING
	RETTILINEITÀ DEGLI SPIGOLI STRAIGHTNESS OF SIDES - GERADLINIGKEIT DER KANTEN RECTITUDE DES ARETES - RECTITUD DE LOS CANTOS КОСОУГОЛЬНОСТЬ - 边角平直度	EN ISO 10545-2	± 0,3% MAX (± 0,8 mm MAX)	CONFORME COMPLYING
	ORTOGONALITÀ RECTANGULARITY - RECHTWINKLIGKEIT PERPENDICULARITÉ - ORTOGONALIDAD КРИВИЗНА СТОРОН - 直角度	EN ISO 10545-2	± 0,3% MAX (± 1,5 mm MAX)	CONFORME COMPLYING
	PLANARITÀ SURFACE FLATNESS - EBENFLÄCHIGKEIT PLANEITE DE SURFACE - PLANEIDAD КРИВИЗНА ЛИЦЕВОЙ ПОВЕРХНОСТИ - 平整度	EN ISO 10545-2	± 0,4% MAX (± 1,8 mm MAX)	CONFORME COMPLYING
	ASSORBIMENTO D'ACQUA WATER ABSORPTION - WASSERAUFNAHME ABSORPTION D'EAU - ABSORCIÓN DE AGUA ВОДОПОГЛОЩЕНИЕ - 吸水率	EN ISO 10545-3	≤ 0,5%	≤ 0,1%
	RESISTENZA ALLA FLESSIONE FLEXION RESISTANCE - BIEGEFESTIGKEIT RESISTANCE A LA FLEXION - RESISTENCIA A LA FLEXIÓN ПРЕДЕЛ ПРОЧНОСТИ ПРИ ИЗГИБЕ - 抗弯强度	EN ISO 10545-4	S ≥ 700 N (< 7,5 mm) S ≥ 1.300 N (> 7,5 mm) R ≥ 35 N/mm².	≥ 6 mm: S≥1100N R≥45 N/mm² ≥ 9 mm: S≥2.400N R≥48 N/mm² ≥ 12 mm: S≥4.000N R≥48 N/mm² ≥ 20 mm: S≥12.500N R≥48 N/mm²
	RESISTENZA ALL'URTO IMPACT RESISTANCE - STOSSFESTIGKEIT RESISTANCE AUX CHOCS - RESISTENCIA A LOS GOLPES УДАРСТОЙКОСТЬ - 抗冲击强度	EN ISO 10545-5	VALORE DICHIARATO DECLARED VALUE	> 0,80
	RESISTENZA ALL'ABRAZIONE ABRASION RESISTANCE - ABRIEBFESTIGKEIT RESISTANCE A L'ABRASION - RESISTENCIA A LA ABRASIÓN СТОЙКОСТЬ К ИСТИРАНИЮ - 耐磨强度	EN ISO 10545-6	≤ 175 mm³	< 150 mm³
	COEFFICIENTE DI DILATAZIONE TERMICA LINEARE COEFFICIENT OF LINEAR THERMAL-EXPANSION - LINEARER WÄRMEAUSSDEHNUNGSKOEFFIZIENT COEFFICIENT DE DILATATION THERMIQUE LINEAIRE - COEFICIENTE DE DILATACIÓN TÉRMICA LINEAL КОЭФФИЦИЕНТ ЛИНЕЙНОГО ТЕРМИЧЕСКОГО РАСТЯЖЕНИЯ - 线性热膨胀系数	EN ISO 10545-8	-	α=6,5x10 ⁻⁶ °C ⁻¹
	RESISTENZA AGLI SBALZI TERMICI RESISTANCE TO THERMAL SHOCKS - BESTÄNDIGKEIT GEGEN TEMPERATURSCHWANKUNGEN RESISTANCE AUX CHOCS THERMIQUES - RESISTENCIA A LOS CHOQUES TÉRMICOS СТОЙКОСТЬ К ПЕРЕПАДАМ ТЕМПЕРАТУРЫ - 耐热突变性	EN ISO 10545-9	TEST SUPERATO SECONDO EN ISO 10545-1 PASS ACCORDING EN ISO 10545-1	NESSUN DANNO NO DAMAGE
	RESISTENZA AL GELO FROST RESISTANCE - FROSTBESTÄNDIGKEIT RESISTANCE AU GEL - RESISTENCIA AL HIELO МОРОЗОСТОЙКОСТЬ - 耐冻性	EN ISO 10545-12	TEST SUPERATO SECONDO EN ISO 10545-1 PASS ACCORDING EN ISO 10545-1	NESSUN DANNO NO DAMAGE
	RESISTENZA ALL'ATTACCO CHIMICO RESISTANCE TO CHEMICALS - CHEMIKALIENBESTÄNDIGKEIT RESISTANCE A L'ATTAQUE CHIMIQUE - RESISTENCIA QUÍMICA ХИМИЧЕСКАЯ СТОЙКОСТЬ - 耐化学品作用	EN ISO 10545-13	B MIN.	A LA HA
	RESISTENZA ALLE MACCHIE RESISTANCE TO STAINS - FLECKENBESTÄNDIGKEIT RESISTANCE AUX TACHES - RESISTENCIA A LAS MANCHAS УСТОЙЧИВОСТЬ К ПЯТНООБРАЗОВАНИЮ - 防污性	EN ISO 10545-14	VALORE DICHIARATO DECLARED VALUE	5
	CESSIONE DI PIOMBO E CADMIO LEAD AND CADMIUM DISCHARGE - ABGABE VON BLEI UND CADMIUM PERTE DE PLOMB ET CADMIUM - CESIÓN DE PLOMO Y CADMIO ВЫДЕЛЕНИЕ СВИНЦА И КАДМИЯ - 铅和镉的排放	EN ISO 10545-15	VALORE DICHIARATO DECLARED VALUE	< AL LIMITE DI RILEVAMENTO < THAN INSTRUMENT LIMIT
				NAT ST ST 20 mm
	DM 236/89 BCRA		> 0,40	> 0,40 > 0,40 > 0,40
	ANSI A326.3		Wet and Dry	≥ 0,42 ≥ 0,55 ≥ 0,55
	AS 4586		-	P2 P4 P4
	DIN 51130		-	R10 R11 R11
	DIN 51097		-	A A+B+C A+B+C
	UNE 41901		≥ CL1	CL2 CL3 CL3
	BS 7976 sl.96-4S		Wet and Dry	≥ 0,36 ≥ 0,36 ≥ 0,36
	BS 7976 sl.55-TRL		Wet and Dry	- - -
	SCIVOLOSITÀ SKID RESISTANCE - RUTSCHWERT GLISSANCE - ADHERENCIA СКОЛЬЗКОСТЬ - 防滑性			

Per i certificati specifici, contattare Mirage SpA - For specific certificates, please contact Mirage SpA - Für die speziellen Zertifikate wenden Sie sich bitte an Mirage SpA - Pour les certificats spécifiques, veuillez contacter Mirage SpA
 Para los certificados específicos, contactar Mirage SpA - Для сертификатов обращайтесь в компанию Mirage SpA - 关于具体的证书, 请联系Mirage Spa公司



Cold **NM 03** 300x600 / 12"x24" NAT RECT

NOVEMB3R

**Elegance with TIMELESS STYLE,
minimalism that becomes an
expressive language.**

Novemb3r is the Mirage® collection that wins over any space with its sophistication and clear design intentions:
to tell the tale of the simplicity of stone and its colour shades but with the performance of porcelain stoneware.

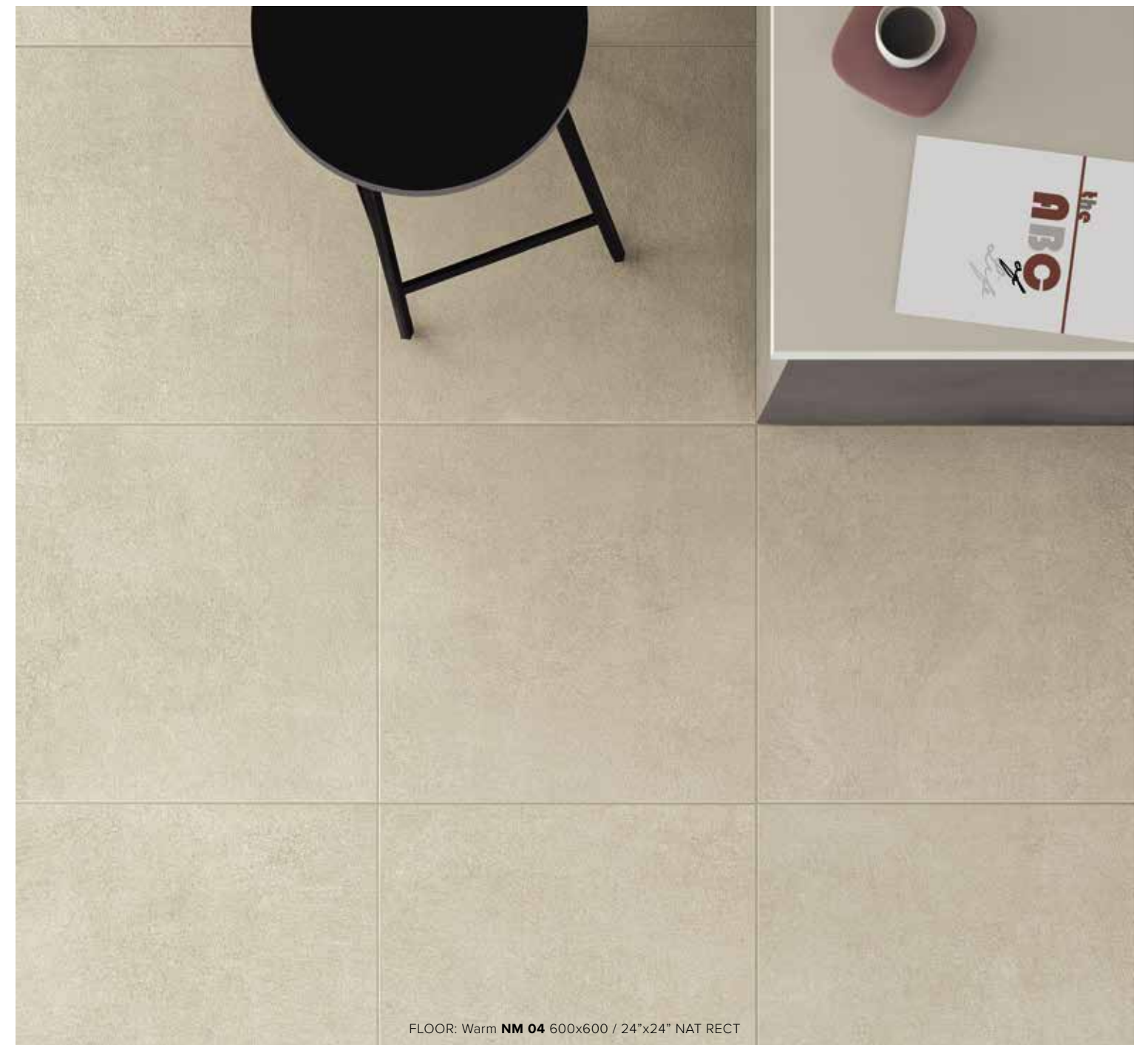

FLOOR: Warm **NM 04** 600x600 / 24"x24" NAT RECT



FLOOR: Wind **NM 02** 600x600 / 24"x24" NAT RECT

COLORI

Colours | Farben | Couleurs | Colores | Цветов | 种颜色



Rain
NM 01



Wind
NM 02



Cold
NM 03



Warm
NM 04



Land
NM 05

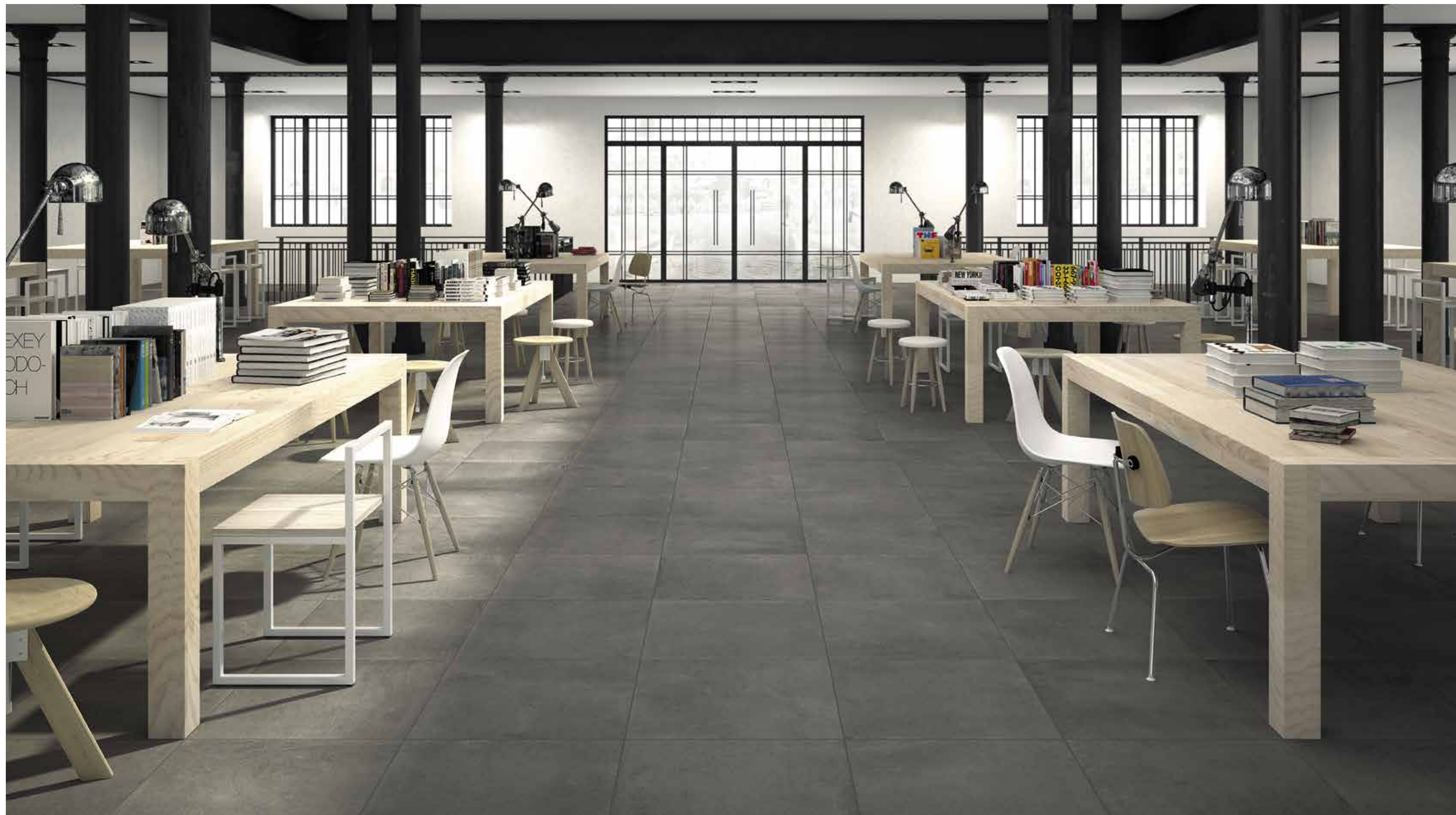

FLOOR: Rain **NM 02** 600x600 / 24"x24" NAT RECT

COLORI

Colours | Farben | Couleurs | Colores | Цветов | 种颜色

RAIN NM 01



Formati Nominali Nominal Sizes		Superficie Finish	Spessore mm Thickness mm
300x600 / 12"x24"		NAT RECT	9
600x600 / 24"x24"		NAT RECT	9
600x600 / 24"x24"		ST RECT	20

Stucchi consigliati Recommended grouts		
KERAKOLL	06	
MAPEI	110 Manhattan	
LATICRETE	89 Smoke Grey	

WARM NM 04



Formati Nominali Nominal Sizes		Superficie Finish	Spessore mm Thickness mm
300x600 / 12"x24"		NAT RECT	9
600x600 / 24"x24"		NAT RECT	9
600x600 / 24"x24"		ST RECT	20

Stucchi consigliati Recommended grouts		
KERAKOLL	07	
MAPEI	111 Grigio Argento	
LATICRETE	88 Silver Shadow	

WIND NM 02



Formati Nominali Nominal Sizes		Superficie Finish	Spessore mm Thickness mm
300x600 / 12"x24"		NAT RECT	9
600x600 / 24"x24"		NAT RECT	9
600x600 / 24"x24"		ST RECT	20

Stucchi consigliati Recommended grouts		
KERAKOLL	08	
MAPEI	112 Grigio Medio	
LATICRETE	78 Sterling Silver	

LAND NM 05



Formati Nominali Nominal Sizes		Superficie Finish	Spessore mm Thickness mm
300x600 / 12"x24"		NAT RECT	9
600x600 / 24"x24"		NAT RECT	9
600x600 / 24"x24"		ST RECT	20

Stucchi consigliati Recommended grouts		
KERAKOLL	09	
MAPEI	113 Grigio Cemento	
LATICRETE	34 Sand Stone	

COLD NM 03



Formati Nominali Nominal Sizes		Superficie Finish	Spessore mm Thickness mm
300x600 / 12"x24"		NAT RECT	9
600x600 / 24"x24"		NAT RECT	9

Stucchi consigliati Recommended grouts		
KERAKOLL	11	
MAPEI	114 Antracite	
LATICRETE	45 Raven	

RIASSUNTIVO FORMATI ED IMBALLI

Summary of sizes and packaging | Übersicht über Formate und Verpackungen | Récapitulatif formats et emballages
Sinóptico de formatos y embalajes | Краткая информация о форматах и упаковках | 规格和包装概述

		9 mm	
Formati Nominali Nominal Sizes		300x600 12"x24"	600x600 24"x24"
Tutti i formati sono rettificati. All sizes are rectified.			
Superficie Finish		NAT	NAT
RAIN NM 01	V2	■	■
WIND NM 02	V2	■	■
COLD NM 03	V2	■	■
WARM NM 04	V2	■	■
LAND NM 05	V2	■	■
Peso lordo per scatola Gross weight per box		25,00	22,13
Pezzi per scatola Pieces for box		7	3
mq. scatola sqm. box		1,26	1,08
Scatole / Full pallet boxes / Full pallet		40	40
mq. pallet sqm. pallet		50,40	43,20

TUTTI I FORMATI IN 9 MM NAT SONO REALIZZATI CON LA TECNOLOGIA PERFORMA (NAT R10 A+B).
All 9 mm NAT sizes are produced with PERFORMA technology (NAT R10 A+B).

		20 mm	
Formati Nominali Nominal Sizes		600x600 24"x24"	
Tutti i formati sono rettificati. All sizes are rectified.			
Superficie Finish		ST	
RAIN NM 01	V2	■	
WIND NM 02	V2	■	
WARM NM 04	V2	■	
LAND NM 05	V2	■	
Peso lordo per scatola Gross weight per box		31,14	
Pezzi per scatola Pieces for box		2	
mq. scatola sqm. box		0,72	
Scatole / Full pallet boxes / Full pallet		30	
mq. pallet sqm. pallet		21,60	

NAT: Naturale | Natural | Natur/unpoliert | Naturelle | Natural | Натуральный | 天然

ST: Strutturata | Structured | Strukturiert | Structuré | Estructurado | Труктурированный | 结构

PEZZI SPECIALI

Special pieces | Sonderstücke | Pièces spéciales | Piezas especiales | специальные изделия | 特殊件

	Battiscopa*	Gradino A*	Gradino B ang.	Gradino B
Pezzi speciali Special pieces	72x600 27½"x24"	300x600 12"x24"	330x330 13½"x13½"	330x600 13½"x24"
Superficie Finish	NAT	NAT	NAT	NAT
RAIN NM 01	■	■	■	■
WIND NM 02	■	■	■	■
COLD NM 03	■	■	■	■
WARM NM 04	■	■	■	■
LAND NM 05	■	■	■	■
Pezzi per scatola Pieces for box	10	7	4	4

* **Finitura a becco di civetta** | One-round edge shaping | Ausführung mit Eckabrundung | Façonnage à bord rond | Acabado canto romo | Плитка с завалом | 鹰嘴边缘处理

MY NOTES

.....

.....

.....

.....

.....

Maggiori informazioni
More information



CARATTERISTICHE TECNICHE

Technical specifications | Technische Eigenschaften | Caractéristiques techniques | Características técnicas | Технические характеристики | 技术特征



STANDARD EN 14411 - G

	CARATTERISTICHE TECNICHE TECHNICAL DATA TECHNISCHE DATEN CARACTERISTIQUES TECHNIQUES CARACTERÍSTICAS TÉCNICAS ТЕХНИЧЕСКИЕ ХАРАКТЕРИСТИКИ 技术特征	NORMA STANDARD NORM NORME NORMA НОРМА ЗНАЧЕНИЯ 标准	VALORI PRESCRITTI DALLE NORME EN 14411 - G INTERNATIONAL STANDARDS EN 14411 - G INTERNATIONALE NORMWERTE EN 14411 - G VALEURS PREVUES PAR LES NORMES EN 14411 - G VALORES PREVISTOS POR LAS NORMAS EN 14411 - G ПРЕДУСМОТРЕННЫЕ СТАНДАРТНОМ EN 14411-G EN 14411 - G标准规定值	*VALORE MEDIO MIRAGE MIRAGE AVERAGE VALUE MIRAGE MITTELWERT VALEURS MOYEN MIRAGE VALOR MEDIO MIRAGE СРЕДНЕЕ ЗНАЧЕНИЕ MIRAGE MIRAGE平均值
	CARATTERISTICHE DIMENSIONALI - SIZE CHARACTERISTICS - MASSEIGENSCHAFTEN DETERMINATION DES CARACTERISTIQUES DIMENSIONNELLES - CARACTERÍSTICAS DIMENSIONALES - РАЗМЕРНЫЕ ХАРАКТЕРИСТИКИ - 尺寸特征			
	LATI SIDES - SEITEN COTES - CANTOS РАЗМЕРЫ СТОРОН - 侧边	EN ISO 10545-2	± 0,3% MAX (± 1,0 mm MAX)	CONFORME COMPLYING
	SPESSORE THICKNESS - DICKE EPAISSEUR - ESPESOR ТОЛЩИНА - 厚度	EN ISO 10545-2	± 5,0% MAX (± 0,5 mm MAX)	CONFORME COMPLYING
	RETTILINEITÀ DEGLI SPIGOLI STRAIGHTNESS OF SIDES - GERADLINIGKEIT DER KANTEN RECTITUDE DES ARETES - RECTITUD DE LOS CANTOS КОСОУГОЛЬНОСТЬ - 边角平直度	EN ISO 10545-2	± 0,3% MAX (± 0,8 mm MAX)	CONFORME COMPLYING
	ORTOGONALITÀ RECTANGULARITY - RECHTWINKLIGKEIT PERPENDICULARITÉ - ORTOGONALIDAD КРИВИЗНА СТОРОН - 直角度	EN ISO 10545-2	± 0,3% MAX (± 1,5 mm MAX)	CONFORME COMPLYING
	PLANARITÀ SURFACE FLATNESS - EBENFLÄCHIGKEIT PLANEITE DE SURFACE - PLANEIDAD КРИВИЗНА ЛИЦЕВОЙ ПОВЕРХНОСТИ - 平整度	EN ISO 10545-2	± 0,4% MAX (± 1,8 mm MAX)	CONFORME COMPLYING
	ASSORBIMENTO D'ACQUA WATER ABSORPTION - WASSERAUFNAHME ABSORPTION D'EAU - ABSORCIÓN DE AGUA ВОДОПОГЛОЩЕНИЕ - 吸水率	EN ISO 10545-3	≤ 0,5%	≤ 0,1%
	RESISTENZA ALLA FLESSIONE FLEXION RESISTANCE - BIEGEFESTIGKEIT RESISTANCE A LA FLEXION - RESISTENCIA A LA FLEXIÓN ПРЕДЕЛ ПРОЧНОСТИ ПРИ ИЗГИБЕ - 抗弯强度	EN ISO 10545-4	S ≥ 700 N (< 7,5 mm) S ≥ 1.300 N (> 7,5 mm) R ≥ 35 N/mm².	±9 mm: S≥2.400N R≥48N/mm² ±20 mm: S≥12.500N R≥48N/mm²
	RESISTENZA ALL'URTO IMPACT RESISTANCE - STOSSEFESTIGKEIT RESISTANCE AUX CHOCS - RESISTENCIA A LOS GOLPES УДАРОСТОЙКОСТЬ - 抗冲击强度	EN ISO 10545-5	VALORE DICHIARATO DECLARED VALUE	> 0,80
	RESISTENZA ALL'ABRAZIONE ABRASION RESISTANCE - ABRIEBFESTIGKEIT RESISTANCE A L'ABRASION - RESISTENCIA A LA ABRASIÓN СТОЙКОСТЬ К ИСТИРАНИЮ - 耐磨强度	EN ISO 10545-6	≤ 175 mm³	< 150 mm³
	COEFFICIENTE DI DILATAZIONE TERMICA LINEARE COEFFICIENT OF LINEAR THERMAL-EXPANSION - LINEARER WÄRMEAUSSDEHNUNGSKOEFFIZIENT COEFFICIENT DE DILATATION THERMIQUE LINEAIRE - COEFICIENTE DE DILATACIÓN TÉRMICA LINEAL КОЭФФИЦИЕНТ ЛИНЕЙНОГО ТЕРМИЧЕСКОГО РАСТЯЖЕНИЯ - 线性热膨胀系数	EN ISO 10545-8	-	α=6,1x10 ⁻⁶ °C ⁻¹
	RESISTENZA AGLI SBALZI TERMICI RESISTANCE TO THERMAL SHOCKS - BESTÄNDIGKEIT GEGEN TEMPERATURSCHWANKUNGEN RESISTANCE AUX CHOCS THERMIQUES - RESISTENCIA A LOS CHOQUES TÉRMICOS СТОЙКОСТЬ К ПЕРЕПАДАМ ТЕМПЕРАТУРЫ - 耐热突变性	EN ISO 10545-9	TEST SUPERATO SECONDO EN ISO 10545-1 PASS ACCORDING EN ISO 10545-1	NESSUN DANNO NO DAMAGE
	RESISTENZA AL GELO FROST RESISTANCE - FROSTBESTÄNDIGKEIT RESISTANCE AU GEL - RESISTENCIA AL HIELO МОРОЗОСТОЙКОСТЬ - 耐冻性	EN ISO 10545-12	TEST SUPERATO SECONDO EN ISO 10545-1 PASS ACCORDING EN ISO 10545-1	NESSUN DANNO NO DAMAGE
	RESISTENZA ALL'ATTACCO CHIMICO RESISTANCE TO CHEMICALS - CHEMIKALIENBESTÄNDIGKEIT RESISTANCE A L'ATTAQUE CHIMIQUE - RESISTENCIA QUÍMICA ХИМИЧЕСКАЯ СТОЙКОСТЬ - 耐化学作用	EN ISO 10545-13	B MIN.	A LA HA
	RESISTENZA ALLE MACCHIE RESISTANCE TO STAINS - FLECKENBESTÄNDIGKEIT RESISTANCE AUX TACHES - RESISTENCIA A LAS MANCHAS УСТОЙЧИВОСТЬ К ПЯТНООБРАЗОВАНИЮ - 防污性	EN ISO 10545-14	VALORE DICHIARATO DECLARED VALUE	5
	CESSIONE DI PIOMBO E CADMIO LEAD AND CADMIUM DISCHARGE - ABGABE VON BLEI UND CADMIUM PERTE DE PLOMB ET CADMIUM - CESIÓN DE PLOMO Y CADMIO ВЫДЕЛЕНИЕ СВИНЦА И КАДМИЯ - 铅和镉的排放	EN ISO 10545-15	VALORE DICHIARATO DECLARED VALUE	< AL LIMITE DI RILEVAMENTO < THAN INSTRUMENT LIMIT
				NAT R10 ST
		DM 236/89 BCRA	> 0,40	> 0,40 > 0,40
		ANSI A326.3	Wet and Dry	≥ 0,42 ≥ 0,55
		AS 4586	-	P3 P4
		DIN 51130	-	R10 R11
		DIN 51097	-	A+B A+B+C
		UNE 41901	≥ CL1	CL2 CL3
		BS 7976 sl.96-4S	Wet and Dry	≥ 0,36 ≥ 0,36
		BS 7976 sl.55-TRL	Wet and Dry	≥ 0,36 ≥ 0,36
	SCIVOLOSITÀ SKID RESISTANCE - RUTSCHWERT GLISSANCE - ADHERENCIA СКОЛЬЗКОСТЬ - 防滑性			

Per i certificati specifici, contattare Mirage SpA - For specific certificates, please contact Mirage SpA - Für die speziellen Zertifikate wenden Sie sich bitte an Mirage SpA - Pour les certificats spécifiques, veuillez contacter Mirage SpA - Para los certificados específicos, contactar Mirage SpA - Для сертификатов обращайтесь в компанию Mirage SpA - 关于具体的证书, 请联系Mirage SpA公司



WALL: Torching **NY 03** 1200x2780 / 48"x110" SP RECT
FLOOR: Torching **NY 03** 800x800 / 31½"x31½" NAT RECT
VANITY UNIT: BATHMOOD Glad **NY 03** SP + BATHMOOD Round Bliss Mirror
SEAT: BATHMOOD Stay **OU 04** SP

NYUMA

The Mirage® interpretation of concrete in its roughest version.

Nyuma reinterprets the composition of the classic concrete casting, inspired by the aesthetics of the formwork, with contrasts without exceeding in its defects.



OUTDOOR WALL: MAND Terracotta **MD 03** MELLOW 300x450 / 12"x18" NOT RECT
OUTDOOR FLOOR: Parker **NY 04** 600x1200 / 24"x48"ST RECT EVO_2/E" ± 20 mm
INDOOR FLOOR: Parker **NY 04** 600x1200 / 24"x48" NAT RECT



COLORI

Colours | Farben | Couleurs | Colores | Цветов | 种颜色



WALL: Quicklime **NY 01** 1200x2780 / 48"x110" SP RECT
FLOOR: Quicklime **NY 01** 1200x1200 / 48"x48" NAT RECT



WALL: Talcum **NY 05** 1200x2780 / 48"x110" SP RECT
FLOOR: Talcum **NY 05** 1200x1200 / 48"x48" NAT RECT
KITCHEN WALL & COUNTER: NORR Hav **RR 06** NAT



WALL: Shotcrete **NY 06** 600x1200 / 24"x48" NAT RECT + REFLET Soirée **RF 01** 200x600 / 8"x24" ANTIQUE
FLOOR: Shotcrete **NY 06** 1200x1200 / 48"x48" NAT RECT



FLOOR: Torching **NY 03** 800x800 / 31½"x31½" ST RECT EVO_2/E" ± 20 mm

COLORI

Colours | Farben | Couleurs | Colores | Цветов | 种颜色

QUICKLIME NY 01



Formati Nominali Nominal Sizes	Superficie Finish	Spessore mm Thickness mm
300x600 / 12"x24"	NAT RECT	9
600x600 / 24"x24"	NAT / ST RECT	9
600x1200 / 24"x48"	NAT RECT	9
800x800 / 31½"x31½"	NAT RECT	9
1200x1200 / 48"x48"	NAT RECT	9
800x1600 / 31½"x63"	SP RECT	9
1200x2780 / 48"x110"	SP RECT	6
600x600 / 24"x24"	ST RECT	20
600x1200 / 24"x48"	ST RECT	20
800x800 / 31½"x31½"	ST RECT	20

Stucchi consigliati Recommended grouts		
KERAKOLL	06	
MAPEI	112 Grigio Medio	
LATICRETE	78 Sterling Silver	

PORTLAND NY 02



Formati Nominali Nominal Sizes	Superficie Finish	Spessore mm Thickness mm
300x600 / 12"x24"	NAT RECT	9
600x600 / 24"x24"	NAT / ST RECT	9
600x1200 / 24"x48"	NAT RECT	9
800x800 / 31½"x31½"	NAT RECT	9
1200x1200 / 48"x48"	NAT RECT	9
800x1600 / 31½"x63"	SP RECT	9
1200x2780 / 48"x110"	SP RECT	6
600x600 / 24"x24"	ST RECT	20
600x1200 / 24"x48"	ST RECT	20
800x800 / 31½"x31½"	ST RECT	20

Stucchi consigliati Recommended grouts		
KERAKOLL	08	
MAPEI	113 Grigio Cemento	
LATICRETE	78 Sterling Silver	

TORCHING NY 03



Formati Nominali Nominal Sizes	Superficie Finish	Spessore mm Thickness mm
300x600 / 12"x24"	NAT RECT	9
600x600 / 24"x24"	NAT / ST RECT	9
600x1200 / 24"x48"	NAT RECT	9
800x800 / 31½"x31½"	NAT RECT	9
1200x1200 / 48"x48"	NAT RECT	9
800x1600 / 31½"x63"	SP RECT	9
1200x2780 / 48"x110"	SP RECT	6
600x600 / 24"x24"	ST RECT	20
600x1200 / 24"x48"	ST RECT	20
800x800 / 31½"x31½"	ST RECT	20

Stucchi consigliati Recommended grouts		
KERAKOLL	08	
MAPEI	113 Grigio Cemento	
LATICRETE	78 Sterling Silver	

PARKER NY 04



Formati Nominali Nominal Sizes	Superficie Finish	Spessore mm Thickness mm
300x600 / 12"x24"	NAT RECT	9
600x600 / 24"x24"	NAT / ST RECT	9
600x1200 / 24"x48"	NAT RECT	9
800x800 / 31½"x31½"	NAT RECT	9
1200x1200 / 48"x48"	NAT RECT	9
600x600 / 24"x24"	ST RECT	20
600x1200 / 24"x48"	ST RECT	20
800x800 / 31½"x31½"	ST RECT	20

Stucchi consigliati Recommended grouts		
KERAKOLL	06	
MAPEI	112 Grigio Medio	
LATICRETE	78 Sterling Silver	

TALCUM NY 05



Formati Nominali Nominal Sizes	Superficie Finish	Spessore mm Thickness mm
300x600 / 12"x24"	NAT RECT	9
600x600 / 24"x24"	NAT / ST RECT	9
600x1200 / 24"x48"	NAT RECT	9
800x800 / 31½"x31½"	NAT RECT	9
1200x1200 / 48"x48"	NAT RECT	9
800x1600 / 31½"x63"	SP RECT	9
1200x2780 / 48"x110"	SP RECT	6
600x600 / 24"x24"	ST RECT	20
600x1200 / 24"x48"	ST RECT	20
800x800 / 31½"x31½"	ST RECT	20

Stucchi consigliati Recommended grouts		
KERAKOLL	05	
MAPEI	111 Grigio Argento	
LATICRETE	88 Silver Shadow	

SHOTCRETE NY 06



Formati Nominali Nominal Sizes	Superficie Finish	Spessore mm Thickness mm
300x600 / 12"x24"	NAT RECT	9
600x600 / 24"x24"	NAT / ST RECT	9
600x1200 / 24"x48"	NAT RECT	9
800x800 / 31½"x31½"	NAT RECT	9
1200x1200 / 48"x48"	NAT RECT	9
600x600 / 24"x24"	ST RECT	20
600x1200 / 24"x48"	ST RECT	20
800x800 / 31½"x31½"	ST RECT	20

Stucchi consigliati Recommended grouts		
KERAKOLL	09	
MAPEI	113 Grigio Cemento	
LATICRETE	60 Dusty Grey	

RIASSUNTIVO FORMATI ED IMBALLI

Summary of sizes and packaging | Übersicht über Formate und Verpackungen | Récapitulatif formats et emballages
Sinóptico de formatos y embalajes | Краткая информация о форматах и упаковках | 规格和包装概述

		± 9 mm						
Formati Nominali Nominal Sizes		300x600 12"x24"	600x600 24"x24"	600x1200 24"x48"	800x800 31½"x31½"	800x1600 31½"x63"	1200x1200 48"x48"	
Tutti i formati sono rettificati. All sizes are rectified.								
Superficie Finish		NAT	NAT	ST	NAT	NAT	SP	NAT
QUICKLIME NY 01	V3	■	■	■	■	■	■	■
PORTLAND NY 02	V3	■	■	■	■	■	■	■
TORCHING NY 03	V3	■	■	■	■	■	■	■
PARKER NY 04	V3	■	■	■	■	■	-	■
TALCUM NY 05	V3	■	■	■	■	■	■	■
SHOTCRETE NY 06	V3	■	■	■	■	■	-	■
Peso lordo per scatola Gross weight per box		25,58	22,13	22,12	30,00	25,23	55,12	61,56
Pezzi per scatola Pieces for box		7	3	3	2	2	2	2
mq. scatola sqm. box		1,26	1,08	1,08	1,44	1,28	2,56	2,88
Scatole / Full pallet boxes / Full pallet		40	40	40	35	48	16	20
mq. pallet sqm. pallet		50,40	43,20	43,20	50,40	61,44	40,96	57,60

TUTTI I FORMATI IN 9 MM NAT SONO REALIZZATI CON LA TECNOLOGIA PERFORMA.
All 9 mm NAT sizes are produced with PERFORMA technology.

		± 6 mm		± 20 mm	
Formati Nominali Nominal Sizes		1200x2780 48"x110"	600x600 24"x24"	600x1200 24"x48"	800x800 31½"x31½"
Tutti i formati sono rettificati. All sizes are rectified.					
Superficie Finish		SP	ST	ST	ST
QUICKLIME NY 01	V3	■	■	■	■
PORTLAND NY 02	V3	■	■	■	■
TORCHING NY 03	V3	■	■	■	■
PARKER NY 04	V3	-	■	■	■
TALCUM NY 05	V3	■	■	■	■
SHOTCRETE NY 06	V3	-	■	■	■
Peso lordo per scatola Gross weight per box			-	32,00	28,50
Pezzi per scatola Pieces for box		Please refer to page 588	2	1	1
mq. scatola sqm. box			0,72	0,72	0,64
Scatole / Full pallet boxes / Full pallet			30	35	42
mq. pallet sqm. pallet			21,60	25,20	26,88

Per tutti i grandi formati è possibile prevedere, su richiesta, e con un lotto minimo l'applicazione di una stuoia in fibra di vetro.
For big sizes, a fibreglass mat can be applied on request, with a minimum production batch.

ACCORDIMENTI SPECIFICI PER L'APPLICAZIONE DELLE GRANDI LASTRE IN 6 MM DI SPESSORE: p. 582 | Precautions for 6mm big slabs applications: page 582 | spezifische Anweisungen zur Nutzung der Grossformate in 6mm: seite 582 | Precauciones específicas para la aplicación de las grandes placas en 6 mm de espesor: page 582 | Precautions spécifiques pour la pose des grandes plaques en 6mm d'épaisseur: página 582 | специальные предосторожности для укладки больших плит толщиной 6 мм : страница 582

PEZZI SPECIALI

Special pieces | Sonderstücke | Pièces spéciales | Piezas especiales | специальные изделия | 特殊件

		Battiscopa*	Battiscopa*	Gradino A*	Gradino A*	Gradino A*	Gradino G*
Pezzi speciali Special pieces		72x600 27½"x24"	72x800 27½"x31½"	300x600 12"x24"	330x800 13½"x31½"	330x1200 13½"x48"	300x600 12"x24"
Superficie Finish		NAT	NAT	NAT	NAT	NAT	NAT
QUICKLIME NY 01		■	■	■	■	■	■
PORTLAND NY 02		■	■	■	■	■	■
TORCHING NY 03		■	■	■	■	■	■
PARKER NY 04		■	■	■	■	■	■
TALCUM NY 05		■	■	■	■	■	■
SHOTCRETE NY 06		■	■	■	■	■	■
Pezzi per scatola Pieces for box		10	10	7	7	4	7

* Finitura a becco di civetta | One-round edge shaping | Ausführung mit Eckabrundung | Façonnage à bord rond | Acabado canto romo | Плитка с завалом | 鹰嘴边缘处理

		Gradino G*	Gradino B ang.	Gradino B	Gradino B	Gradino B
Pezzi speciali Special pieces		330x800 13½"x31½"	330x330 13½"x13½"	330x600 13½"x24"	330x800 13½"x31½"	330x1200 13½"x48"
Superficie Finish		NAT	NAT	NAT	NAT	NAT
QUICKLIME NY 01		■	■	■	■	■
PORTLAND NY 02		■	■	■	■	■
TORCHING NY 03		■	■	■	■	■
PARKER NY 04		■	■	■	■	■
TALCUM NY 05		■	■	■	■	■
SHOTCRETE NY 06		■	■	■	■	■
Pezzi per scatola Pieces for box		7	4	4	4	2

MY NOTES

.....

.....

.....

.....

.....

Maggiori informazioni
More information



NAT: Naturale | Natural | Natur/unpoliert | Naturelle | Natural | Натуральный | 天然
ST: Strutturata | Structured | Strukturiert | Structuré | Estructurado | Труктурированный | 结构
SP: Spazzolata

DECORI

Decors | Dekore | Decors | Decoros | Декоры | 装饰砖

Mosaico 36T NAT
300x300 / 12"x12"
Tessere 48x48 / 2"x2"

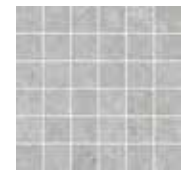

QUICKLIME NY 01

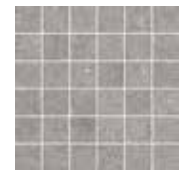

PORTLAND NY 02

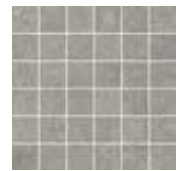

TORCHING NY 03



PARKER NY 04



TALCUM NY 05

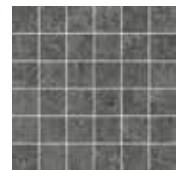

SHOTCRETE NY 06

Portnoy NAT
300x300 / 12"x12"

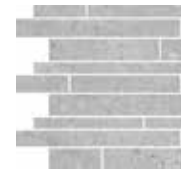

QUICKLIME NY 01



PORTLAND NY 02



TORCHING NY 03



PARKER NY 04



TALCUM NY 05



SHOTCRETE NY 06

Japan Mix NAT
300x300 / 12"x12"



QUICKLIME NY 01
+ JINKOH OU 03

MOSAICO 36T, PORTNOY, JAPAN MIX:
Decoro su rete | Mesh-backed decoration | Dekor auf netz | Décor sur filet | Decoración en red | Декор в сету | 网板背帖装饰件

	Pezzi per scatola Pieces for box
Mosaico 36T	6
Portnoy	6
Japan Mix	6

CARATTERISTICHE TECNICHE

Technical specifications | Technische Eigenschaften | Caractéristiques techniques | Características técnicas | Технические характеристики | 技术特征

STANDARD EN 14411 - G

	CARATTERISTICHE TECNICHE TECHNICAL DATA TECHNISCHE DATEN CARACTERISTIQUES TECHNIQUES CARACTERÍSTICAS TÉCNICAS ТЕХНИЧЕСКИЕ ХАРАКТЕРИСТИКИ 技术特征	NORMA STANDARD NORM NORME NORMA НОРМА 标准	VALORI PRESCRITTI DALLE NORME EN 14411 - G INTERNATIONAL STANDARDS EN 14411 - G INTERNATIONALE NORMWERTE EN 14411 - G VALEURS PREVUES PAR LES NORMES EN 14411 - G VALORES PREVISTOS POR LAS NORMAS EN 14411 - G ПРЕДУСМОТРЕННЫЕ СТАНДАРТOM EN 14411-G EN 14411 - G标准规定值	*VALORE MEDIO MIRAGE MIRAGE AVERAGE VALUE MIRAGE MITTELWERT VALEURS MOYEN MIRAGE VALOR MEDIO MIRAGE СРЕДНЕЕ ЗНАЧЕНИЕ MIRAGE MIRAGE平均值
	CARATTERISTICHE DIMENSIONALI - SIZE CHARACTERISTICS - MASSEIGENSCHAFTEN DETERMINATION DES CARACTERISTIQUES DIMENSIONNELLES - CARACTERÍSTICAS DIMENSIONALES - РАЗМЕРНЫЕ ХАРАКТЕРИСТИКИ - 尺寸特征			
	LATI SIDES - SEITEN COTES - CANTOS РАЗМЕРЫ СТОРОН - 側邊	EN ISO 10545-2	± 0,3% MAX (± 1,0 mm MAX)	CONFORME COMPLYING
	SPESSORE THICKNESS - DICKE EPAISSEUR - ESPESOR ТОЛЩИНА - 厚度	EN ISO 10545-2	± 5,0% MAX (± 0,5 mm MAX)	CONFORME COMPLYING
	RETTILINEITÀ DEGLI SPIGOLI STRAIGHTNESS OF SIDES - GERADLINIGKEIT DER KANTEN RECTITUDE DES ARETES - RECTITUD DE LOS CANTOS КОСОУГОЛЬНОСТЬ - 边角平直度	EN ISO 10545-2	± 0,3% MAX (± 0,8 mm MAX)	CONFORME COMPLYING
	ORTOGONALITÀ RECTANGULARITY - RECHTWINKLIGKEIT PERPENDICULARITÉ - ORTOGONALIDAD КРИВИЗНА СТОРОН - 直角度	EN ISO 10545-2	± 0,3% MAX (± 1,5 mm MAX)	CONFORME COMPLYING
	PLANARITÀ SURFACE FLATNESS - EBENFLÄCHIGKEIT PLANEITE DE SURFACE - PLANEIDAD КРИВИЗНА ЛИЦЕВОЙ ПОВЕРХНОСТИ - 平整度	EN ISO 10545-2	± 0,4% MAX (± 1,8 mm MAX)	CONFORME COMPLYING
	ASSORBIMENTO D'ACQUA WATER ABSORPTION - WASSERAUFNAHME ABSORPTION D'EAU - ABSORCIÓN DE AGUA ВОДОПОГЛОЩЕНИЕ - 吸水率	EN ISO 10545-3	≤ 0,5%	≤ 0,1%
	RESISTENZA ALLA FLESSIONE FLEXION RESISTANCE - BIEGEFESTIGKEIT RESISTANCE A LA FLEXION - RESISTENCIA A LA FLEXIÓN ПРЕДЕЛ ПРОЧНОСТИ ПРИ ИЗГИБЕ - 抗弯强度	EN ISO 10545-4	S ≥ 700 N (< 7,5 mm) S ≥ 1.300 N (> 7,5 mm) R ≥ 35 N/mm².	≠6 mm: S ≥ 1100 N R ≥ 45 N/mm² ≠9 mm: S ≥ 2.400 N R ≥ 48 N/mm² ≠20 mm: S ≥ 12.500 N R ≥ 48 N/mm²
	RESISTENZA ALL'URTO IMPACT RESISTANCE - STOSSFESTIGKEIT RESISTANCE AUX CHOCES - RESISTENCIA A LOS GOLPES УДАРСТОЙКОСТЬ - 抗冲击强度	EN ISO 10545-5	VALORE DICHIARATO DECLARED VALUE	> 0,80
	RESISTENZA ALL'ABRASIONE ABRASION RESISTANCE - ABRIEBFESTIGKEIT RESISTANCE A L'ABRASION - RESISTENCIA A LA ABRASIÓN СТОЙКОСТЬ К ИСТИРАНИЮ - 耐磨强度	EN ISO 10545-6	≤ 175 mm³	< 150 mm³
	COEFFICIENTE DI DILATAZIONE TERMICA LINEARE COEFFICIENT OF LINEAR THERMAL-EXPANSION - LINEARER WÄRMEAUSSDEHNUNGSKOEFFIZIENT COEFFICIENT DE DILATATION THERMIQUE LINEAIRE - COEFICIENTE DE DILATACIÓN TÉRMICA LINEAL КОЭФФИЦИЕНТ ЛИНЕЙНОГО ТЕРМИЧЕСКОГО РАСТЯЖЕНИЯ - 线性热膨胀系数	EN ISO 10545-8	-	α=6,6x10 ⁻⁶ °C ⁻¹
	RESISTENZA AGLI SBALZI TERMICI RESISTANCE TO THERMAL SHOCKS - BESTÄNDIGKEIT GEGEN TEMPERATURSCHWANKUNGEN RESISTANCE AUX CHOCES THERMIQUES - RESISTENCIA A LOS CHOQUES TÉRMICOS СТОЙКОСТЬ К ПЕРЕПАДАМ ТЕМПЕРАТУРЫ - 耐热突变性	EN ISO 10545-9	TEST SUPERATO SECONDO EN ISO 10545-1 PASS ACCORDING EN ISO 10545-1	NESSUN DANNO NO DAMAGE
	RESISTENZA AL GELO FROST RESISTANCE - FROSTBESTÄNDIGKEIT RESISTANCE AU GEL - RESISTENCIA AL HIELO МОРОЗОСТОЙКОСТЬ - 耐冻性	EN ISO 10545-12	TEST SUPERATO SECONDO EN ISO 10545-1 PASS ACCORDING EN ISO 10545-1	NESSUN DANNO NO DAMAGE
	RESISTENZA ALL'ATTACCO CHIMICO RESISTANCE TO CHEMICALS - CHEMIKALIENBESTÄNDIGKEIT RESISTANCE A L'ATTAQUE CHIMIQUE - RESISTENCIA QUÍMICA ХИМИЧЕСКАЯ СТОЙКОСТЬ - 耐化学品作用	EN ISO 10545-13	UB MIN.	A LA HA
	RESISTENZA ALLE MACCHIE RESISTANCE TO STAINS - FLECKENBESTÄNDIGKEIT RESISTANCE AUX TACHES - RESISTENCIA A LAS MANCHAS УСТОЙЧИВОСТЬ К ПЯТНООБРАЗОВАНИЮ - 防污性	EN ISO 10545-14	VALORE DICHIARATO DECLARED VALUE	5
	CESSIONE DI PIOMBO E CADMIO LEAD AND CADMIUM DISCHARGE - ABGABE VON BLEI UND CADMIUM PERTE DE PLOMB ET CADMIUM - CESIÓN DE PLOMO Y CADMIO ВЫДЕЛЕНИЕ СВИНЦА И КАДМИЯ - 铅和镉的排放	EN ISO 10545-15	VALORE DICHIARATO DECLARED VALUE	< AL LIMITE DI RILEVAMENTO < THAN INSTRUMENT LIMIT
	SCIVOLosità SKID RESISTANCE - RUTSCHWERT GLISSANCE - ADHERENCIA СКОЛЬЗКОСТЬ - 防滑性			SP NAT ST ST 20 mm
	DM 236/89 BCRA	> 0,40	> 0,40 > 0,40 > 0,40 > 0,40	
	ANSI A326.3	Wet and Dry	≥ 0,42 ≥ 0,42 ≥ 0,55 ≥ 0,55	
	AS 4586	-	P2 P3 - -	
	DIN 51130	-	R9 R10 R11 R11	
	DIN 51097	-	A+B A+B+C A+B+C	
	UNE 41901	≥ CL1	CL1 CL1 CL3 CL3	
	BS 7976 sl.96-4S	Wet and Dry	- ≥ 0,36 ≥ 0,36 ≥ 0,36	
	BS 7976 sl.55-TRL	Wet and Dry	- ≥ 0,36 ≥ 0,36 ≥ 0,36	

Per i certificati specifici, contattare Mirage SpA - For specific certificates, please contact Mirage SpA - Für die speziellen Zertifikate wenden Sie sich bitte an Mirage SpA - Pour les certificats spécifiques, veuillez contacter Mirage SpA
Para los certificados específicos, contactar Mirage SpA - Для сертификатов обращайтесь в компанию Mirage SpA - 关于具体的证书, 请联系Mirage SpA公司



Dark **OF 03** 600x600 / 24"x24" ST RECT EVO_2/E™ 20 mm

OFFICINE

Officine comes in the EVO_2/E™ version. The Officine slabs for outdoor use take on a concrete effect, featuring all the characteristics of porcelain stoneware in a 20-mm thickness.

This collection is the fruit of a painstaking process of **research** and **experimentation**, bringing an underground, cosmopolitan edge to each setting.



Romantic **OF 02** 600x600 / 24"x24" ST RECT EVO_2/E™ 20 mm



COLORI

Colours | Farben | Couleurs | Colores | Цветов | 种颜色



Romantic
OF 02



Dark
OF 03







Gothic
OF 04





COLORI

Colours | Farben | Couleurs | Colores | Цветов | 种颜色

ROMANTIC OF 02







 Formati Nominali Nominal Sizes	 Superficie Finish	 Spessore mm Thickness mm
 600x600 / 24"x24"	ST RECT	20



 Stucchi consigliati Recommended grouts		
KERAKOLL	06	
MAPEI	110 Manhattan	
LATICRETE	89 Smoke Grey	



DARK OF 03





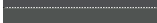

 Formati Nominali Nominal Sizes	 Superficie Finish	 Spessore mm Thickness mm
 600x600 / 24"x24"	ST RECT	20



 Stucchi consigliati Recommended grouts		
KERAKOLL	11	
MAPEI	114 Antracite	
LATICRETE	45 Raven	



GOTHIC OF 04





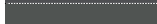









 Formati Nominali Nominal Sizes	 Superficie Finish	 Spessore mm Thickness mm
 600x600 / 24"x24"	ST RECT	20

 Stucchi consigliati Recommended grouts		
KERAKOLL	11	
MAPEI	114 Antracite	
LATICRETE	45 Raven	



RIASSUNTIVO FORMATI ED IMBALLI

Summary of sizes and packaging | Übersicht über Formate und Verpackungen | Récapitulatif formats et emballages
Sinóptico de formatos y embalajes | Краткая информация о форматах и упаковках | 规格和包装概述

 Formati Nominali Nominal Sizes	600x600 24"x24"	
Tutti i formati sono rettificati. All sizes are rectified.		
 Superficie Finish	ST	
 ROMANTIC OF 02	V2	
 DARK OF 03	V2	
 GOTHIC OF 04	V2	
 Peso lordo per scatola Gross weight per box	31,14	
 Pezzi per scatola Pieces for box	2	
 mq. scatola sqm. box	0,72	
 Scatole / Full pallet boxes / Full pallet	30	
 mq. pallet sqm. pallet	21,60	

GO 2/e ± 20 mm

MY NOTES

.....

.....

.....

.....

.....

 **Maggiori informazioni**
More information





Gothic OF 04 600x600 / 24"x24" ST RECT EVO_2/E" ± 20 mm

CARATTERISTICHE TECNICHE

Technical specifications | Technische Eigenschaften | Caractéristiques techniques | Características técnicas | Технические характеристики | 技术特征

STANDARD EN 14411 - G

	CARATTERISTICHE TECNICHE TECHNICAL DATA TECHNISCHE DATEN CARACTERISTIQUES TECHNIQUES CARACTERÍSTICAS TÉCNICAS ТЕХНИЧЕСКИЕ ХАРАКТЕРИСТИКИ 技术特征	NORMA STANDARD NORM NORME NORMA ЗНАЧЕНИЯ 标准	VALORI PRESCRITTI DALLE NORME EN 14411 - G INTERNATIONAL STANDARDS EN 14411 - G INTERNATIONALE NORMWERTE EN 14411 - G VALEURS PREVUES PAR LES NORMES EN 14411 - G VALORES PREVISTOS POR LAS NORMAS EN 14411 - G ПРЕДУСМОТРЕННЫЕ СТАНДАРТОМ EN 14411-G EN 14411 - G标准规定值	*VALORE MEDIO MIRAGE MIRAGE AVERAGE VALUE MIRAGE MITTELWERT VALEURS MOYEN MIRAGE VALOR MEDIO MIRAGE СРЕДНЕЕ ЗНАЧЕНИЕ MIRAGE MIRAGE平均值
	CARATTERISTICHE DIMENSIONALI - SIZE CHARACTERISTICS - MASSEIGENSCHAFTEN DETERMINATION DES CARACTERISTIQUES DIMENSIONNELLES - CARACTERÍSTICAS DIMENSIONALES - РАЗМЕРНЫЕ ХАРАКТЕРИСТИКИ - 尺寸特征			
	LATI SIDES - SEITEN COTES - CANTOS РАЗМЕРЫ СТОРОН - 侧边	EN ISO 10545-2	± 0,3% MAX (± 1,0 mm MAX)	CONFORME COMPLYING
	SPESORE THICKNESS - DICKE EPAISSEUR - ESPESOR ТОЛЩИНА - 厚度	EN ISO 10545-2	± 5,0% MAX (± 0,5 mm MAX)	CONFORME COMPLYING
	RETTILINEITÀ DEGLI SPIGOLI STRAIGHTNESS OF SIDES - GERADLINIGKEIT DER KANTEN RECTITUDE DES ARETES - RECTITUD DE LOS CANTOS КОСОУГОЛЬНОСТЬ - 边角平直度	EN ISO 10545-2	± 0,3% MAX (± 0,8 mm MAX)	CONFORME COMPLYING
	ORTOGONALITÀ RECTANGULARITY - RECHTWINKLIGKEIT PERPENDICULARITÉ - ORTOGONALIDAD КРИВИЗНА СТОРОН - 直角度	EN ISO 10545-2	± 0,3% MAX (± 1,5 mm MAX)	CONFORME COMPLYING
	PLANARITÀ SURFACE FLATNESS - EBENFLÄCHIGKEIT PLANEITE DE SURFACE - PLANEIDAD КРИВИЗНА ЛИЦЕВОЙ ПОВЕРХНОСТИ - 平整度	EN ISO 10545-2	± 0,4% MAX (± 1,8 mm MAX)	CONFORME COMPLYING
	ASSORBIMENTO D'ACQUA WATER ABSORPTION - WASSERAUFNAHME ABSORPTION D'EAU - ABSORCIÓN DE AGUA ВОДОПОГЛОЩЕНИЕ - 吸水率	EN ISO 10545-3	≤ 0,5%	≤ 0,1%
	RESISTENZA ALLA FLESSIONE FLEXION RESISTANCE - BIEGEFESTIGKEIT RESISTANCE A LA FLEXION - RESISTENCIA A LA FLEXIÓN ПРЕДЕЛ ПРОЧНОСТИ ПРИ ИЗГИБЕ - 抗弯强度	EN ISO 10545-4	S ≥ 700 N (< 7,5 mm) S ≥ 1.300 N (> 7,5 mm) R ≥ 35 N/mm².	≥ 20 mm: S≥12.500N R≥48 N/mm²
	RESISTENZA ALL'URTO IMPACT RESISTANCE - STOSSFESTIGKEIT RESISTANCE AUX CHOCES - RESISTENCIA A LOS GOLPES УДАРОСТОЙКОСТЬ - 抗冲击强度	EN ISO 10545-5	VALORE DICHIARATO DECLARED VALUE	> 0,80
	RESISTENZA ALL'ABRASIONE ABRASION RESISTANCE - ABRIEBFESTIGKEIT RESISTANCE A L'ABRASION - RESISTENCIA A LA ABRASIÓN СТОЙКОСТЬ К ИСТИРАНИЮ - 耐磨强度	EN ISO 10545-6	≤ 175 mm³	< 150 mm³
	COEFFICIENTE DI DILATAZIONE TERMICA LINEARE COEFFICIENT OF LINEAR THERMAL-EXPANSION - LINEARER WÄRMEAUSSDEHNUNGSKOEFFIZIENT COEFFICIENT DE DILATATION THERMIQUE LINEAIRE - COEFICIENTE DE DILATACIÓN TÉRMICA LINEAL КОЭФФИЦИЕНТ ЛИНЕЙНОГО ТЕРМИЧЕСКОГО РАСТЯЖЕНИЯ - 线性热膨胀系数	EN ISO 10545-8	-	α=6,2x10 ⁻⁶ °C ⁻¹
	RESISTENZA AGLI SBALZI TERMICI RESISTANCE TO THERMAL SHOCKS - BESTÄNDIGKEIT GEGEN TEMPERATURSCHWANKUNGEN RESISTANCE AUX CHOCES THERMIQUES - RESISTENCIA A LOS CHOQUES TÉRMICOS СТОЙКОСТЬ К ПЕРЕПАДАМ ТЕМПЕРАТУРЫ - 耐热突变性	EN ISO 10545-9	TEST SUPERATO SECONDO EN ISO 10545-1 PASS ACCORDING EN ISO 10545-1	NESSUN DANNO NO DAMAGE
	RESISTENZA AL GELO FROST RESISTANCE - FROSTBESTÄNDIGKEIT RESISTANCE AU GEL - RESISTENCIA AL HIELO МОРОЗОСТОЙКОСТЬ - 耐冻性	EN ISO 10545-12	TEST SUPERATO SECONDO EN ISO 10545-1 PASS ACCORDING EN ISO 10545-1	NESSUN DANNO NO DAMAGE
	RESISTENZA ALL'ATTACCO CHIMICO RESISTANCE TO CHEMICALS - CHEMIKALIENBESTÄNDIGKEIT RESISTANCE A L'ATTAQUE CHIMIQUE - RESISTENCIA QUÍMICA ХИМИЧЕСКАЯ СТОЙКОСТЬ - 耐化学品作用	EN ISO 10545-13	B MIN.	A LA HA
	RESISTENZA ALLE MACCHIE RESISTANCE TO STAINS - FLECKENBESTÄNDIGKEIT RESISTANCE AUX TACHES - RESISTENCIA A LAS MANCHAS УСТОЙЧИВОСТЬ К ПЯТНООБРАЗОВАНИЮ - 防污性	EN ISO 10545-14	VALORE DICHIARATO DECLARED VALUE	5
	CESSIONE DI PIOMBO E CADMIO LEAD AND CADMIUM DISCHARGE - ABGABE VON BLEI UND CADMIUM PERTE DE PLOMB ET CADMIUM - CESIÓN DE PLOMO Y CADMIO ВЫДЕЛЕНИЕ СВИНЦА И КАДМИЯ - 铅和镉的排放	EN ISO 10545-15	VALORE DICHIARATO DECLARED VALUE	< AL LIMITE DI RILEVAMENTO < THAN INSTRUMENT LIMIT
				ST 20 mm
		DM 236/89 BCRA	> 0,40	> 0,40
		ANSI A326.3	Wet and Dry	≥ 0,55
		AS 4586	-	P4
		DIN 51130	-	R11
		DIN 51097	-	A+B+C
		UNE 41901	≥ CL1	CL3
		BS 7976 sl.96-4S	Wet and Dry	≥ 0,36
		BS 7976 sl.55-TRL	Wet and Dry	-

SCIVOLOSITÀ
SKID RESISTANCE - RUTSCHWERT
GLISSANCE - ADHERENCIA
СКОЛЬЗКОСТЬ - 防滑性

Per i certificati specifici, contattare Mirage SpA - For specific certificates, please contact Mirage SpA - Für die speziellen Zertifikate wenden Sie sich bitte an Mirage SpA - Pour les certificats spécifiques, veuillez contacter Mirage SpA - Para los certificados específicos, contactar Mirage SpA - Для сертификатов обращайтесь в компанию Mirage SpA - 关于具体的证书, 请联系Mirage SpA公司



WALL: PAPIER Jardin 600x1200 / 24"x48" SP RECT
FLOOR: Laos **OU 05** 250x1500 / 10"x60" SP RECT

ODUH

A collection with delicate and elegantly classic patterns with perfectly balanced contrasts and knots.

ODUH comes in 7 natural colours, running from cream to olive passing through the more classic shades of wood.



FLOOR: Pino **OU 04** Florio 1200x1200 / 48"x48" SP RECT



WALL: Jinkoh **OU 03** 200x2780 / 8"x110" + 1200x2780 / 48"x110" SP RECT
 FLOOR: Jinkoh **OU 03** 200x1200 / 8"x48" GP RECT
 BATH TUB: VICEVERSA Perla **VV 02** SP

COLORI

Colours | Farben | Couleurs | Colores | Цветов | 种颜色





INDOOR FLOOR: Cedro **OU 07** 250x1500 / 10"x60" SP RECT
OUTDOOR FLOOR: Cedro **OU 07** 300x1200 / 12"x48" RD RECT EVO_2/E" ± 20 mm



WALL: Jinkoh **OU 03** 1200x2780 / 48"x110" SP RECT
FLOOR: Jinkoh **OU 03** 200x1200 / 8"x48" SP RECT
BEDSIDE TABLE: COSMOPOLITAN Arabescato Oro **CP 03** LUC

COLORI

Colours | Farben | Couleurs | Colores | Цветов | 种颜色

COPAHU OU 01



Formati Nominali Nominal Sizes		Superficie Finish	Spessore mm Thickness mm
200x1200 / 8"x48"	SP / GP RECT	9	
250x1500 / 10"x60"	SP RECT	9	
300x2400 / 12"x96"	SP RECT	9	
300x1200 / 12"x48"	RD RECT	20	

Stucchi consigliati Recommended grouts		
KERAKOLL	44	
MAPEI	111 Grigio Argento	
LATICRETE	17 Marble Beige	



PINO OU 04



Formati Nominali Nominal Sizes		Superficie Finish	Spessore mm Thickness mm
200x1200 / 8"x48"	SP / GP RECT	9	
200x1800 / 8"x72"	SP RECT	9	
250x1500 / 10"x60"	SP RECT	9	
300x2400 / 12"x96"	SP RECT	9	
200x2780 / 8"x110"	SP RECT	6	
1200x2780 / 48"x110"	SP RECT	6	
300x1200 / 12"x48"	RD RECT	20	

Stucchi consigliati Recommended grouts		
KERAKOLL	26	
MAPEI	135	
LATICRETE	56 Desert Khaki	



ELEM OU 02



Formati Nominali Nominal Sizes		Superficie Finish	Spessore mm Thickness mm
200x1200 / 8"x48"	SP / GP RECT	9	
250x1500 / 10"x60"	SP RECT	9	
300x1200 / 12"x48"	RD RECT	20	

Stucchi consigliati Recommended grouts		
KERAKOLL	26	
MAPEI	112 Grigio Medio	
LATICRETE	24 Natural Grey	



LAOS OU 05



Formati Nominali Nominal Sizes		Superficie Finish	Spessore mm Thickness mm
200x1200 / 8"x48"	SP / GP RECT	9	
200x1800 / 8"x72"	SP RECT	9	
250x1500 / 10"x60"	SP RECT	9	
300x2400 / 12"x96"	SP RECT	9	
200x2780 / 8"x110"	SP RECT	6	
1200x2780 / 48"x110"	SP RECT	6	
300x1200 / 12"x48"	RD RECT	20	

Stucchi consigliati Recommended grouts		
KERAKOLL	34	
MAPEI	147	
LATICRETE	30 Sand Beige	



JINKOH OU 03



Formati Nominali Nominal Sizes		Superficie Finish	Spessore mm Thickness mm
200x1200 / 8"x48"	SP / GP RECT	9	
200x1800 / 8"x72"	SP RECT	9	
250x1500 / 10"x60"	SP RECT	9	
300x2400 / 12"x96"	SP RECT	9	
200x2780 / 8"x110"	SP RECT	6	
1200x2780 / 48"x110"	SP RECT	6	
300x1200 / 12"x48"	RD RECT	20	

Stucchi consigliati Recommended grouts		
KERAKOLL	31	
MAPEI	133	
LATICRETE	40 Latte	



LADANO OU 06



Formati Nominali Nominal Sizes		Superficie Finish	Spessore mm Thickness mm
200x1200 / 8"x48"	SP / GP RECT	9	
250x1500 / 10"x60"	SP RECT	9	
300x1200 / 12"x48"	RD RECT	20	

Stucchi consigliati Recommended grouts		
KERAKOLL	28	
MAPEI	136	
LATICRETE	35 Mocha	



COLORI

Colours | Farben | Couleurs | Colores | Цветов | 种颜色

CEDRO OU 07



Formati Nominali Nominal Sizes	Superficie Finish	Spessore mm Thickness mm
200x1200 / 8"x48"	SP / GP RECT	9
250x1500 / 10"x60"	SP RECT	9
300x1200 / 12"x48"	RD RECT	20

Stucchi consigliati Recommended grouts	
KERAKOLL	26
MAPEI	134
LATICRETE	24 Natural Grey



FLOOR: Laos **OU 05** Ubud 180x585 / 7"x23" SP

RIASSUNTIVO FORMATI ED IMBALLI

Summary of sizes and packaging | Übersicht über Formate und Verpackungen | Récapitulatif formats et emballages
Sinóptico de formatos y embalajes | Краткая информация о форматах и упаковках | 规格和包装概述

		± 9 mm				
Formati Nominali Nominal Sizes		200x1200 8"x48"	250x1500 10"x60"	200x1800 8"x72"	300x2400 12"x96"	
Tutti i formati sono rettificati. All sizes are rectified.						
Superficie Finish		SP	GP	SP	SP	SP
	COPAHU OU 01	V2	■	■	-	■
	ELEM OU 02	V2	■	■	-	-
	JINKOH OU 03	V2	■	■	■	■
	PINO OU 04	V2	■	■	■	■
	LAOS OU 05	V2	■	■	■	■
	LADANO OU 06	V2	■	■	-	-
	CEDRO OU 07	V2	■	■	-	-
	Peso lordo per scatola Gross weight per box	30,24	30,24	23,58	-	
	Pezzi per scatola Pieces for box	6	6	3	-	Please refer to page 588
	mq. scatola sqm. box	1,44	1,44	1,125	-	
	Scatole / Full pallet boxes / Full pallet	32	32	30	-	
	mq. pallet sqm. pallet	46,08	46,08	33,75	-	

		± 6 mm		± 20 mm
Formati Nominali Nominal Sizes		200x2780 8"x110"	1200x2780 48"x110"	300x1200 12"x48"
Tutti i formati sono rettificati. All sizes are rectified.				
Superficie Finish		SP	SP	RD
	COPAHU OU 01	V2	-	■
	ELEM OU 02	V2	-	■
	JINKOH OU 03	V2	■	■
	PINO OU 04	V2	■	■
	LAOS OU 05	V2	■	■
	LADANO OU 06	V2	-	■
	CEDRO OU 07	V2	-	■
	Peso lordo per scatola Gross weight per box			31,25
	Pezzi per scatola Pieces for box	Please refer to page 588	Please refer to page 588	2
	mq. scatola sqm. box			0,72
	Scatole / Full pallet boxes / Full pallet			36
	mq. pallet sqm. pallet			25,20

Per tutti i grandi formati è possibile prevedere, su richiesta, e con un lotto minimo l'applicazione di una stuoia in fibra di vetro.
For big sizes, a fibreglass mat can be applied on request, with a minimum production batch.

ACCORGIMENTI SPECIFICI PER L'APPLICAZIONE DELLE GRANDI LASTRE IN 6 MM DI SPESSORE: p. 582 | Precautions for 6mm big slabs applications: page 582 | spezifische Anweisungen zur Nutzung der Grossformate in 6mm: seite 582 | Precauciones específicas para la aplicación de las grandes placas en 6 mm de espesor: page 582 | Precautions spécifiques pour la pose des grandes plaques en 6mm d'épaisseur: página 582 | специальные предосторожности для укладки больших плит толщиной 6 мм : страница 582

PEZZI SPECIALI

Special pieces | Sonderstücke | Pièces spéciales | Piezas especiales | специальные изделия | 特殊件

		Battiscopa*	Gradino A*	Gradino B
Pezzi speciali Special pieces		72x600 27/8"x24"	330x1200 131/8"x48"	330x1200 131/8"x48"
Superficie Finish		SP	SP	SP
	COPAHU OU 01	■	■	■
	ELEM OU 02	■	■	■
	JINKOH OU 03	■	■	■
	PINO OU 04	■	■	■
	LAOS OU 05	■	■	■
	LADANO OU 06	■	■	■
	CEDRO OU 07	■	■	■
	Pezzi per scatola Pieces for box	10	4	2

* Finitura a becco di civetta | One-round edge shaping | Ausführung mit Eckabrundung | Façonnage à bord rond | Acabado canto romo | Плитка с завалом | 鹰嘴边缘处理

MY NOTES

.....

.....

.....

.....

.....

Maggiori informazioni
More information



SP: Spazzolata
RD: Radiale
GP: Grip

DECORI

Decors | Dekore | Decors | Decoros | Декоры | 装饰砖

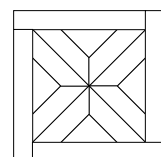

Florio SP
1200x1200 / 48"x48"



COPAHU **OU 01**



JINKOH **OU 03**



PINO **OU 04**



JINKOH **OU 03** + LINCOLN **JL 04**



Stick SP
300x600 / 12"x24"
Tessere 10x600 / 3/8"x24"



COPAHU **OU 01**



ELEM **OU 02**

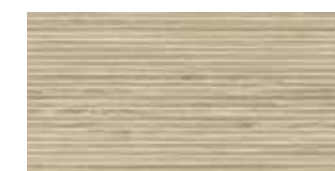

JINKOH **OU 03**



PINO **OU 04**



LAOS **OU 05**



LADANO **OU 06**



CEDRO **OU 07**



Ubud SP
180x585 / 7"x23"



COPAHU **OU 01**



ELEM **OU 02**



JINKOH **OU 03**



PINO **OU 04**



LAOS **OU 05**



LADANO **OU 06**



CEDRO **OU 07**



Pezzi per scatola
Pieces for box

Stick	2
Ubud	6 (3 dx + 3 sx)
Florio	2

STICK, UBUD:
Decoro su rete | Mesh-backed decoration | Dekor auf netz | Décor sur filet | Decoración en red | Декор в сету | 网板背帖装饰件



CARATTERISTICHE TECNICHE

Technical specifications | Technische Eigenschaften | Caractéristiques techniques | Características técnicas | Технические характеристики | 技术特征

STANDARD EN 14411 - G

CARATTERISTICHE TECNICHE TECHNICAL DATA TECHNISCHE DATEN CARACTERISTIQUES TECHNIQUES CARACTERÍSTICAS TÉCNICAS ТЕХНИЧЕСКИЕ ХАРАКТЕРИСТИКИ 技术特征		NORMA STANDARD NORM NORME NORMA ЗНАЧЕНИЯ 标准	VALORI PRESCRITTI DALLE NORME EN 14411 - G INTERNATIONAL STANDARDS EN 14411 - G INTERNATIONALE NORMWERTE EN 14411 - G VALEURS PREVUES PAR LES NORMES EN 14411 - G VALORES PREVISTOS POR LAS NORMAS EN 14411 - G ПРЕДУСМОТРЕННЫЕ СТАНДАРТОВ EN 14411-G EN 14411 - G标准规定值	*VALORE MEDIO MIRAGE MIRAGE AVERAGE VALUE MIRAGE MITTELWERT VALEURS MOYEN MIRAGE VALOR MEDIO MIRAGE СРЕДНЕЕ ЗНАЧЕНИЕ MIRAGE MIRAGE平均值		
CARATTERISTICHE DIMENSIONALI - SIZE CHARACTERISTICS - MASSEIGENSCHAFTEN DETERMINATION DES CARACTERISTIQUES DIMENSIONNELLES - CARACTERÍSTICAS DIMENSIONALES - РАЗМЕРНЫЕ ХАРАКТЕРИСТИКИ - 尺寸特征				SP	GP	RD 20mm
LATI SIDES - SEITEN COTES - CANTOS РАЗМЕРЫ СТОРОН - 側边	EN ISO 10545-2	± 0,3% MAX (± 1,0 mm MAX)	CONFORME COMPLYING			
SPESORE THICKNESS - DICKE EPAISSEUR - ESPESOR ТОЛЩИНА - 厚度	EN ISO 10545-2	± 5,0% MAX (± 0,5 mm MAX)	CONFORME COMPLYING			
RETTILINEITÀ DEGLI SPIGOLI STRAIGHTNESS OF SIDES - GERADLINIGKEIT DER KANTEN RECTITUDE DES ARETES - RECTITUD DE LOS CANTOS КОСОУГОЛЬНОСТЬ - 边角平直度	EN ISO 10545-2	± 0,3% MAX (± 0,8 mm MAX)	CONFORME COMPLYING			
ORTOGONALITÀ RECTANGULARITY - RECHTWINKLIGKEIT PERPENDICULARITÉ - ORTOGONALIDAD КРИВИЗНА СТОРОН - 直角度	EN ISO 10545-2	± 0,3% MAX (± 1,5 mm MAX)	CONFORME COMPLYING			
PLANARITÀ SURFACE FLATNESS - EBENFLÄCHIGKEIT PLANEITE DE SURFACE - PLANEIDAD КРИВИЗНА ЛИЦЕВОЙ ПОВЕРХНОСТИ - 平整度	EN ISO 10545-2	± 0,4% MAX (± 1,8 mm MAX)	CONFORME COMPLYING			
ASSORBIMENTO D'ACQUA WATER ABSORPTION - WASSERAUFNAHME ABSORPTION D'EAU - ABSORCIÓN DE AGUA ВОДОПОГЛОЩЕНИЕ - 吸水率	EN ISO 10545-3	≤ 0,5%	≤ 0,1%			
RESISTENZA ALLA FLESSIONE FLEXION RESISTANCE - BIEGEFESTIGKEIT RESISTANCE A LA FLEXION - RESISTENCIA A LA FLEXIÓN ПРЕДЕЛ ПРОЧНОСТИ ПРИ ИЗГИБЕ - 抗弯强度	EN ISO 10545-4	S ≥ 700 N (< 7,5 mm) S ≥ 1.300 N (> 7,5 mm) R ≥ 35 N/mm².	≧6 mm: S ≥ 1100 N R ≥ 45 N/mm² ≧9 mm: S ≥ 2.400 N R ≥ 48 N/mm² ≧20 mm: S ≥ 12.500 N R ≥ 48 N/mm²			
RESISTENZA ALL'URTO IMPACT RESISTANCE - STOSSFESTIGKEIT RESISTANCE AUX CHOCES - RESISTENCIA A LOS GOLPES УДАРСТОЙКОСТЬ - 抗冲击强度	EN ISO 10545-5	VALORE DICHIARATO DECLARED VALUE	> 0,48			
RESISTENZA ALL'ABRASIONE ABRASION RESISTANCE - ABRIEBFESTIGKEIT RESISTANCE A L'ABRASION - RESISTENCIA A LA ABRASIÓN СТОЙКОСТЬ К ИСТИРАНИЮ - 耐磨强度	EN ISO 10545-6	≤ 175 mm³	< 150 mm³			
COEFFICIENTE DI DILATAZIONE TERMICA LINEARE COEFFICIENT OF LINEAR THERMAL-EXPANSION - LINEARER WÄRMEAUDEHNUNGSKOEFFIZIENT COEFFICIENT DE DILATATION THERMIQUE LINEAIRE - COEFICIENTE DE DILATACIÓN TÉRMICA LINEAL КОЭФФИЦИЕНТ ЛИНЕЙНОГО ТЕРМИЧЕСКОГО РАСШИРЕНИЯ - 线性热膨胀系数	EN ISO 10545-8	-	α=6,6x10 ⁻⁶ °C ⁻¹			
RESISTENZA AGLI SBALZI TERMICI RESISTANCE TO THERMAL SHOCKS - BESTÄNDIGKEIT GEGEN TEMPERATURSCHWANKUNGEN RESISTANCE AUX CHOCES THERMIQUES - RESISTENCIA A LOS CHOQUES TÉRMICOS СТОЙКОСТЬ К ПЕРЕПАДАМ ТЕМПЕРАТУРЫ - 耐热突变性	EN ISO 10545-9	TEST SUPERATO SECONDO EN ISO 10545-1 PASS ACCORDING EN ISO 10545-1	NESSUN DANNO NO DAMAGE			
RESISTENZA AL GELO FROST RESISTANCE - FROSTBESTÄNDIGKEIT RESISTANCE AU GEL - RESISTENCIA AL HIELO МОРОЗОСТОЙКОСТЬ - 耐冻性	EN ISO 10545-12	TEST SUPERATO SECONDO EN ISO 10545-1 PASS ACCORDING EN ISO 10545-1	NESSUN DANNO NO DAMAGE			
RESISTENZA ALL'ATTACCO CHIMICO RESISTANCE TO CHEMICALS - CHEMIKALIENBESTÄNDIGKEIT RESISTANCE A L'ATTAQUE CHIMIQUE - RESISTENCIA QUÍMICA ХИМИЧЕСКАЯ СТОЙКОСТЬ - 耐化学品作用	EN ISO 10545-13	B MIN.	A LA HA			
RESISTENZA ALLE MACCHIE RESISTANCE TO STAINS - FLECKENBESTÄNDIGKEIT RESISTANCE AUX TACHES - RESISTENCIA A LAS MANCHAS УСТОЙЧИВОСТЬ К ПЯТНООБРАЗОВАНИЮ - 防污性	EN ISO 10545-14	VALORE DICHIARATO DECLARED VALUE	5			
CESSIONE DI PIOMBO E CADMIO LEAD AND CADMIUM DISCHARGE - ABGABE VON BLEI UND CADMIUM PERTE DE PLOMB ET CADMIUM - CESIÓN DE PLOMO Y CADMIO ВЫДЕЛЕНИЕ СВИНЦА И КАДМИЯ - 铅和镉的排放	EN ISO 10545-15	VALORE DICHIARATO DECLARED VALUE	< AL LIMITE DI RILEVAMENTO < THAN INSTRUMENT LIMIT			
SCIVOLOSITÀ SKID RESISTANCE - RUTSCHWERT GLISSANCE - ADHERENCIA СКОЛЬЗКОСТЬ - 防滑性				SP	GP	RD 20mm
	DM 236/89 BCRA	> 0,40	> 0,40	> 0,40	> 0,40	> 0,40
	ANSI A326.3	Wet and Dry	≥ 0,42	≥ 0,55	≥ 0,55	≥ 0,55
	AS 4586	-	P2	P4	-	-
	DIN 51130	-	R9	R11	R11	R11
	DIN 51097	-	-	A+B+C	A+B+C	A+B+C
	UNE 41901	≥ CL1	CL1	CL3	-	-
	BS 7976 sl.96-4S	Wet and Dry	-	≥ 0,36	-	-
	BS 7976 sl.55-TRL	Wet and Dry	-	≥ 0,36	-	-

Per i certificati specifici, contattare Mirage SpA - For specific certificates, please contact Mirage SpA - Für die speziellen Zertifikate wenden Sie sich bitte an Mirage SpA - Pour les certificats spécifiques, veuillez contacter Mirage SpA
Para los certificados específicos, contactar Mirage SpA - Для сертификатов обращайтесь в компанию Mirage SpA - 关于具体的证书, 请联系Mirage SpA公司



WALL: Esprit Chaud 1200x2780 / 48"x110" LUC RECT + ELYSIAN Beige Catalan **EY 03** 1200x2780 / 48"x110" SP RECT
FLOOR: ELYSIAN Beige Catalan **EY 03** 800x800 / 31½"x31½" SP RECT
SHOWER TRAY: BATHMOOD Appeal **EY 03** SP

PAPIER

Decorative surfaces in porcelain stoneware capable of transforming any setting into a beautiful and comfortable living space.

PAPIER is a project in 120x278 and 60x120 sizes that creates almost pictorial scenes and nurtures creativity towards new inspirations.



WALL: Encanto 600x1200 / 24"x48" SP RECT
FLOOR: CLAY Grace **CL 10** 600x1200 / 24"x48" SP RECT

COLORI
Colours | Farben | Couleurs | Colores | Цветов | 种颜色



WALL: Jardin 600x1200 / 24"x48" SP RECT
FLOOR: GLOCAL SUGAR GC 07 800x800 / 31½"x31½" ST RECT EVO_2/E" ± 20 mm
TABLE & BENCH: GLOCAL SUGAR GC 07 SP





WALL: Encanto Gold 1200x2780 / 48"x110" SP RECT
FLOOR: LEMMY Nimbus LY 02 1200x1200 / 48"x48" SP RECT
DESK: LEMMY Nimbus LY 02 SP



WALL: Soleil 600x1200 / 24"x48" SP RECT
FLOOR: ELYSIAN Beige Catalan **EY 03** 600x1200 / 24"x48" NAT RECT



WALL: Nuages 600x1200 / 24"x48" SP RECT
FLOOR: NOON Daylight **NN 01** 200x1200 / 8"x48" Chevron NAT RECT



COLORI



Colours | Farben | Couleurs | Colores | Цветов | 种颜色

JARDIN





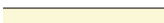

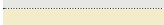

 Formati Nominali Nominal Sizes	 Superficie Finish	 Spessore mm Thickness mm
600x1200 / 24"x48"	SP SQ	6





 Stucchi consigliati Recommended grouts		
KERAKOLL	23	
MAPEI	111 Grigio Argento	
LATICRETE	39 Mushroom	

ENCANTO





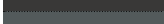



 Formati Nominali Nominal Sizes	 Superficie Finish	 Spessore mm Thickness mm
600x1200 / 24"x48"	SP SQ	6



 Stucchi consigliati Recommended grouts		
KERAKOLL	11	
MAPEI	174 Tornado	
LATICRETE	42 Platinum	

PALM







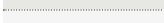

 Formati Nominali Nominal Sizes	 Superficie Finish	 Spessore mm Thickness mm
600x1200 / 24"x48"	SP SQ	6



 Stucchi consigliati Recommended grouts		
KERAKOLL	02	
MAPEI	103 Bianco Luna	
LATICRETE	44 Bright White	

CAMILLE







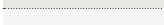

 Formati Nominali Nominal Sizes	 Superficie Finish	 Spessore mm Thickness mm
600x1200 / 24"x48"	SP SQ	6





 Stucchi consigliati Recommended grouts		
KERAKOLL	03	
MAPEI	111 Grigio Argento	
LATICRETE	44 Bright White	

NUAGES









 Formati Nominali Nominal Sizes	 Superficie Finish	 Spessore mm Thickness mm
600x1200 / 24"x48"	SP SQ	6



 Stucchi consigliati Recommended grouts		
KERAKOLL	03	
MAPEI	111 Grigio Argento	
LATICRETE	44 Bright White	

AURORA



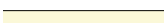

 Formati Nominali Nominal Sizes	 Superficie Finish	 Spessore mm Thickness mm
600x1200 / 24"x48"	SP SQ	6

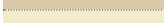
 Stucchi consigliati Recommended grouts		
KERAKOLL	23	
MAPEI	132 Beige 2000	
LATICRETE	39 Mushroom	

COLORI

Colours | Farben | Couleurs | Colores | Цветов | 种颜色

MERVEILLE



	Formati Nominali Nominal Sizes 600x1200 / 24"x48"		Superficie Finish SP SQ		Spessore mm Thickness mm 6	
	Stucchi consigliati Recommended grouts					
	KERAKOLL	05				
	MAPEI	110 Manhattan 2000				
	LATICRETE	88 Silver Shadow				

ENCANTO GOLD



	Formati Nominali Nominal Sizes 1200x2780 / 48"x110"		Superficie Finish SP SQ		Spessore mm Thickness mm 6	
	Stucchi consigliati Recommended grouts					
	KERAKOLL	11				
	MAPEI	174 Tornado				
	LATICRETE	42 Platinum				

SOLEIL



	Formati Nominali Nominal Sizes 600x1200 / 24"x48"		Superficie Finish SP SQ		Spessore mm Thickness mm 6	
	Stucchi consigliati Recommended grouts					
	KERAKOLL	06				
	MAPEI	115 Grigio Fiume				
	LATICRETE	24 Natural Grey				

CAMILLE GOLD



	Formati Nominali Nominal Sizes 1200x2780 / 48"x110"		Superficie Finish SP SQ		Spessore mm Thickness mm 6	
	Stucchi consigliati Recommended grouts					
	KERAKOLL	03				
	MAPEI	290 Crema				
	LATICRETE	44 Bright White				

COROLLE



	Formati Nominali Nominal Sizes 600x1200 / 24"x48"		Superficie Finish SP SQ		Spessore mm Thickness mm 6	
	Stucchi consigliati Recommended grouts					
	KERAKOLL	06				
	MAPEI	112 Grigio Medio				
	LATICRETE	90 Light Pewter				

CAMILLE ROSE



	Formati Nominali Nominal Sizes 1200x2780 / 48"x110"		Superficie Finish SP SQ		Spessore mm Thickness mm 6	
	Stucchi consigliati Recommended grouts					
	KERAKOLL	02				
	MAPEI	103 Bianco Luna				
	LATICRETE	44 Bright White				

COLORI

Colours | Farben | Couleurs | Colores | Цветов | 种颜色

AQUARELLE ROSE



	Formati Nominali Nominal Sizes 1200x2780 / 48"x110"		Superficie Finish SP SQ		Spessore mm Thickness mm 6	
	Stucchi consigliati Recommended grouts					
	KERAKOLL	21				
	MAPEI	137 Caraibi				
	LATICRETE	90 Light Pewter				

AQUARELLE VERT



	Formati Nominali Nominal Sizes 1200x2780 / 48"x110"		Superficie Finish SP SQ		Spessore mm Thickness mm 6	
	Stucchi consigliati Recommended grouts					
	KERAKOLL	20				
	MAPEI	111 Grigio Argento				
	LATICRETE	88 Silver Shadow				

ESPOIR CHAUD



	Formati Nominali Nominal Sizes 1200x2780 / 48"x110"		Superficie Finish LUC SQ		Spessore mm Thickness mm 6	
	Stucchi consigliati Recommended grouts					
	KERAKOLL	24				
	MAPEI	137 Caraibi				
	LATICRETE	85 Almond				

ESPOIR FROID



	Formati Nominali Nominal Sizes 1200x2780 / 48"x110"		Superficie Finish LUC SQ		Spessore mm Thickness mm 6	
	Stucchi consigliati Recommended grouts					
	KERAKOLL	05				
	MAPEI	110 Manhattan 2000				
	LATICRETE	88 Silver Shadow				

MY NOTES

.....

.....

.....

.....

.....

SP: Spazzolata
LUC: Lucido | Glossy | Lucida | Lucida | Lustrado | блестящая | 闪亮

Maggiori informazioni
More information



RIASSUNTIVO FORMATI ED IMBALLI

Summary of sizes and packaging | Übersicht über Formate und Verpackungen | Récapitulatif formats et emballages
Sinóptico de formatos y embalajes | Краткая информация о форматах и упаковках | 规格和包装概述

Formati Nominali Nominal Sizes		600x1200 24"x48"	
Tutti i formati sono rettificati. All sizes are rectified.			
Superficie Finish	SP	SP	
JARDIN	1 graphic available	■	-
ENCANTO	1 graphic available	■	-
PALM	1 graphic available	■	-
CAMILLE	4 graphics available	■	-
NUAGES	1 graphic available	■	-
AURORA	1 graphic available	■	-
MERVEILLE	composition with 2 graphics	-	■
SOLEIL	composition with 2 graphics	-	■
COROLLE	composition with 2 graphics	-	■
Peso lordo per scatola Gross weight per box	30,78		30,00
Pezzi per scatola Pieces for box	3		2
mq. scatola sqm. box	2,16		1,44
Scatole / Full pallet boxes / Full pallet	25		15
mq. pallet sqm. pallet	54,00		21,60

Formati Nominali Nominal Sizes		1200x2780 48"x110"	
Tutti i formati sono rettificati. All sizes are rectified.			
Superficie Finish	SP	LUC	
ENCANTO GOLD	1 graphic available	■	-
CAMILLE GOLD	1 graphic available	■	-
CAMILLE ROSE	1 graphic available	■	-
AQUARELLE ROSE	3 graphics available	■	-
AQUARELLE VERT	3 graphics available	■	-
ESPOIR CHAUD	3 graphics available	-	■
ESPOIR FROID	3 graphics available	-	■
Peso lordo per scatola Gross weight per box			
Pezzi per scatola Pieces for box			
mq. scatola sqm. box	Please refer to page 588		Please refer to page 588
Scatole / Full pallet boxes / Full pallet			
mq. pallet sqm. pallet			

Per tutti i grandi formati è possibile prevedere, su richiesta, e con un lotto minimo l'applicazione di una stuoia in fibra di vetro.
For big sizes, a fibreglass mat can be applied on request, with a minimum production batch.

ACCORGIMENTI GENERALI PER LASTRE IN GRES PORCELLANATO MIRAGE PAPIER: P. 586 | General precautions for Mirage Papier slabs in porcelain stoneware: page 586 | Allgemeine Anweisungen für Mirage Feinsteinzeugplatten der Kollektion Papier: seite 586 | Precautions generales pour les plaques en gres cerame Mirage Papier: page 586 | Recomendaciones generales para las placas de gres porcelánico Mirage Papier: página 586 | Общие рекомендации для плит из керамогранита Mirage Papier : страница 586

ACCORGIMENTI SPECIFICI PER L'APPLICAZIONE DELLE GRANDI LASTRE IN 6 MM DI SPESSORE: p. 582 | Precautions for 6mm big slabs applications: page 582 | spezifische Anweisungen zur Nutzung der Grosseformate in 6mm: seite 582 | Precauciones específicas para la aplicación de las grandes placas en 6 mm de espesor: page 582 | Precautions spécifiques pour la pose des grandes plaques en 6mm d'épaisseur: página 582 | специальные предосторожности для укладки больших плит толщиной 6 мм : страница 582

SP: Spazzolata

LUC: Lucido | Glossy | Lucida | Lucida | Lustrado | блестящая | 闪亮

CARATTERISTICHE TECNICHE

Technical specifications | Technische Eigenschaften | Caractéristiques techniques | Características técnicas | Технические характеристики | 技术特征

STANDARD EN 14411 - G

	CARATTERISTICHE TECNICHE TECHNICAL DATA TECHNISCHE DATEN CARACTERISTIQUES TECHNIQUES CARACTERÍSTICAS TÉCNICAS ТЕХНИЧЕСКИЕ ХАРАКТЕРИСТИКИ 技术特征	NORMA STANDARD NORM NORME NORMA Нормы 标准	VALORI PRESCRITTI DALLE NORME EN 14411 - G INTERNATIONAL STANDARDS EN 14411 - G INTERNATIONALE NORMWERTE EN 14411 - G VALEURS PREVUES PAR LES NORMES EN 14411 - G VALORES PREVISTOS POR LAS NORMAS EN 14411 - G ПРЕДУСМОТРЕННЫЕ СТАНДАРТОМ EN 14411-G EN 14411 - G标准规定值	VALORE MEDIO MIRAGE MIRAGE AVERAGE VALUE MIRAGE MITTELWERT VALOR MEDIO MIRAGE СРЕДНЕЕ ЗНАЧЕНИЕ MIRAGE MIRAGE平均值		
	CARATTERISTICHE DIMENSIONALI - SIZE CHARACTERISTICS - MASSEIGENSCHAFTEN DETERMINATION DES CARACTERISTIQUES DIMENSIONNELLES - CARACTERÍSTICAS DIMENSIONALES - РАЗМЕРНЫЕ ХАРАКТЕРИСТИКИ - 尺寸特征			LUC (GL)	SP (UGL)	SP (GL)
	LATI SIDES - SEITEN COTES - CANTOS РАЗМЕРЫ СТОРОН - 側边	EN ISO 10545-2	± 0,3% MAX (± 1,0 mm MAX)	CONFORME COMPLYING		
	SPESSORE THICKNESS - DICKE ÉPAISSEUR - ESPESOR ТОЛЩИНА - 厚度	EN ISO 10545-2	± 5,0% MAX (± 0,5 mm MAX)	CONFORME COMPLYING		
	RETTILINEITÀ DEGLI SPIGOLI STRAIGHTNESS OF SIDES - GERADLINIGKEIT DER KANTEN RECTITUDE DES ARETÉS - RECTITUD DE LOS CANTOS КОСОУГОЛЬНОСТЬ - 边角平直度	EN ISO 10545-2	± 0,3% MAX (± 0,8 mm MAX)	CONFORME COMPLYING		
	ORTOGONALITÀ RECTANGULARITY - RECHTWINKLIGKEIT PERPENDICULARITE - ORTOGONALIDAD КРИВИЗНА СТОРОН - 直角度	EN ISO 10545-2	± 0,3% MAX (± 1,5 mm MAX)	CONFORME COMPLYING		
	PLANARITÀ SURFACE FLATNESS - EBENFLÄCHIGKEIT PLANEITE DE SURFACE - PLANEIDAD КРИВИЗНА ЛИЦЕВОЙ ПОВЕРХНОСТИ - 平整度	EN ISO 10545-2	± 0,4% MAX (± 1,8 mm MAX)	CONFORME COMPLYING		
	ASSORBIMENTO D'ACQUA WATER ABSORPTION - WASSERAUFNAHME ABSORPTION D'EAU - ABSORCIÓN DE AGUA ВОДОПОГЛОЩЕНИЕ - 吸水率	EN ISO 10545-3	≤ 0,5%	≤ 0,1%		
	RESISTENZA ALLA FLESSIONE FLEXION RESISTANCE - BIEGEFESTIGKEIT RESISTANCE A LA FLEXION - RESISTENCIA A LA FLEXIÓN ПРЕДЕЛ ПРОЧНОСТИ ПРИ ИЗГИБЕ - 抗弯强度	EN ISO 10545-4	S ≥ 700 N (< 7,5 mm) S ≥ 1.300 N (> 7,5 mm) R ≥ 0,48 N/mm².	S≥1100N R≥48 N/mm²		
	RESISTENZA ALL'URTO IMPACT RESISTANCE - STOSSFESTIGKEIT RESISTANCE AUX CHOCES - RESISTENCIA A LOS GOLPES УДАРОСТОЙКОСТЬ - 抗冲击强度	EN ISO 10545-5	VALORE DICHIARATO DECLARED VALUE	> 0,80		
	RESISTENZA ALL'ABRASIONE ABRASION RESISTANCE - ABRIEBFESTIGKEIT RESISTANCE A L'ABRASION - RESISTENCIA A LA ABRASIÓN СТОЙКОСТЬ К ИСТИРАНИЮ - 耐磨强度	EN ISO 10545-6	≤ 175 mm³	< 150 mm³		
	COEFFICIENTE DI DILATAZIONE TERMICA LINEARE COEFFICIENT OF LINEAR THERMAL EXPANSION - LINEARER WÄRMEAUDEHNUNGSKOEFFIZIENT COEFFICIENT DE DILATATION THERMIQUE LINEAIRE - COEFICIENTE DE DILATACIÓN TÉRMICA LINEAL КОЭФФИЦИЕНТ ЛИНЕЙНОГО ТЕРМИЧЕСКОГО РАСТЯЖЕНИЯ - 线性热膨胀系数	EN ISO 10545-8	-	α 6,2x10 ⁻⁶ °C ⁻¹		
	RESISTENZA AGLI SBALZI TERMICI RESISTANCE TO THERMAL SHOCKS - BESTÄNDIGKEIT GEGEN TEMPERATURSCHWANKUNGEN RESISTANCE AUX CHOCES THERMIQUES - RESISTENCIA A LOS CHOQUES TÉRMICOS СТОЙКОСТЬ К ПЕРЕПАДАМ ТЕМПЕРАТУРЫ - 耐热突变性	EN ISO 10545-9	TEST SUPERATO SECONDO EN ISO 10545-1 PASS ACCORDING EN ISO 10545-1	NESSUN DANNO NO DAMAGE		
	RESISTENZA AL GELO FROST RESISTANCE - FROSTBESTÄNDIGKEIT RESISTANCE AU GEL - RESISTENCIA AL HIELO МОРОЗОСТОЙКОСТЬ - 耐冻性	EN ISO 10545-12	TEST SUPERATO SECONDO EN ISO 10545-1 PASS ACCORDING EN ISO 10545-1	NESSUN DANNO NO DAMAGE		
	RESISTENZA ALL'ATTACCO CHIMICO RESISTANCE TO CHEMICALS - CHEMIKALIENBESTÄNDIGKEIT RESISTANCE A L'ATTAQUE CHIMIQUE - RESISTENCIA QUÍMICA ХИМИЧЕСКАЯ СТОЙКОСТЬ - 耐化学药品作用	EN ISO 10545-13	B MIN.	ALA	ALA HA	A
	RESISTENZA ALL'ABRASIONE SUPERFICIALE SURFACE ABRASION RESISTANCE - ABRIEBFESTIGKEIT DER OBERFLÄCHE RESISTANCE À L'ABRASION SUPERFICIELLE - RESISTENCIA A LA ABRASIÓN SUPERFICIAL ХИМИЧЕСКАЯ СТОЙКОСТЬ - 耐表面磨损	EN ISO 10545-7	-	PEI 3	-	-
	RESISTENZA ALLE MACCHIE RESISTANCE TO STAINS - FLECKENBESTÄNDIGKEIT RESISTANCE AUX TACHES - RESISTENCIA A LAS MANCHAS УСТОЙЧИВОСТЬ К ПЯТНООБРАЗОВАНИЮ - 防污性	EN ISO 10545-14	VALORE DICHIARATO DECLARED VALUE	5	5	5
	CESSIONE DI PIOMBO E CADMIO LEAD AND CADMIUM DISCHARGE - ABGABE VON BLEI UND CADMIUM PERTE DE PLOMB ET CADMIUM - CESIÓN DE PLOMO Y CADMIO ВЫДЕЛЕНИЕ СВИНЦА И КАДМИЯ - 铅和镉的排放	EN ISO 10545-15	VALORE DICHIARATO DECLARED VALUE	< AL LIMITE DI RILEVAMENTO < THAN INSTRUMENT LIMIT		
				LUC (GL)	SP (UGL)	SP (GL)
			> 0,40	-	> 0,40	-
			Wet and Dry	-	≥ 0,42	-
			-	-	P2	-
			-	-	R9	-
			-	-	-	-
			≥ CL1	-	CL1	-
			Wet and Dry	-	-	-
			Wet and Dry	-	-	-



SCIVOLOSITÀ
SKID RESISTANCE - RUTSCHWERT
GLISSANCE - ADHERENCIA
СКОЛЬЗКОСТЬ - 防滑性

LUC (GL): Espoir Chaud - Espoir Froid
SP (UGL): Jardin - Encanto - Palm - Camille - Nuages - Aquarelle Rose - Aquarelle Vert - Aurora
SP (GL): Encanto Gold - Camille gold - Camille Rose - Merveille - Soleil - Corolle

Per i certificati specifici, contattare Mirage SPA. - For specific certificates, please contact Mirage SPA - Für die speziellen Zertifikate wenden Sie sich bitte an Mirage SpA - Pour les certificats spécifiques, veuillez contacter Mirage SPA - Para los certificados específicos, contactar Mirage SPA - Для сертификатов обращайтесь в компанию Mirage SpA - 关于具体的证书,请联系Mirage Spa公司

La superficie LUC può essere soggetta a graffi se in contatto con materiali più duri (es sassi, frammenti di piastrella, etc...)
LUC finish can be subjected to scratches if in contact with harder materials (eg stones, tile fragments, etc...)



Glacier **QR 01** 600x600 / 24"x24" NAT RECT

QUARZITI 2.0

For floor and wall solutions,
Quarziti 2.0 is a collection marked by
colour shading that recreates the authentic
heterogeneity of **NATURAL STONE**.

The rich variety of single-calibre modular sizes
ensures full design freedom.



Mantle **QR 05** 300x600 / 12"x24" NAT RECT



Waterfall **QR 03** 200x600 / 8"x24" NAT RECT

COLORI

Colours | Farben | Couleurs | Colores | Цветов | 种颜色



Glacier
QR 01



Mountains
QR 02



Waterfall
QR 03



River
QR 04



Mantle
QR 05



Glacier QR 01 600x600 / 24"x24" NAT RECT EVO_2/E" ± 20 mm



Quarziti 2.0 is available with natural R10 and R12 finishes for outdoors, which on one hand ensures the **highest standards of safety and resistance to slipping**, and on the other the **perfect coordination between indoor and outdoor spaces**.

EFFETTO PIETRA

COLORI

Colours | Farben | Couleurs | Colores | Цветов | 种颜色

GLACIER QR 01



Formati Nominali Nominal Sizes	Superficie Finish	Spessore mm Thickness mm
150x150 / 6"x6"	NAT RECT	9
200x300 / 8"x12"	NAT RECT	9
300x300 / 12"x12"	NAT RECT	9
200x600 / 8"x24"	NAT RECT	9
300x600 / 12"x24"	NAT RECT	9
300x600 / 12"x24"	NAT RECT - R12	9
400x600 / 16"x24"	NAT RECT	9
600x600 / 24"x24"	NAT RECT	9
600x1200 / 24"x48"	NAT RECT	9
300x600 / 12"x24"	NAT RECT	20
600x600 / 24"x24"	NAT RECT	20
450x900 / 18"x36"	NAT RECT	20
600x1200 / 24"x48"	NAT RECT	20

Stucchi consigliati Recommended grouts		
KERAKOLL	07	
MAPEI	111 Grigio Argento	
LATICRETE	88 Silver Shadow	

MOUNTAINS QR 02



Formati Nominali Nominal Sizes	Superficie Finish	Spessore mm Thickness mm
150x150 / 6"x6"	NAT RECT	9
200x300 / 8"x12"	NAT RECT	9
300x300 / 12"x12"	NAT RECT	9
200x600 / 8"x24"	NAT RECT	9
300x600 / 12"x24"	NAT RECT	9
300x600 / 12"x24"	NAT RECT - R12	9
400x600 / 16"x24"	NAT RECT	9
600x600 / 24"x24"	NAT RECT	9
600x1200 / 24"x48"	NAT RECT	9
300x600 / 12"x24"	NAT RECT	20
600x600 / 24"x24"	NAT RECT	20
450x900 / 18"x36"	NAT RECT	20
600x1200 / 24"x48"	NAT RECT	20
Modular 300x600 + 600x900 12"x24" + 24"x36"	NAT RECT	20
600x600 / 24"x24"	NAT RECT	30

Stucchi consigliati Recommended grouts		
KERAKOLL	06	
MAPEI	110 Manhattan	
LATICRETE	89 Smoke Grey	

WATERFALL QR 03



Formati Nominali Nominal Sizes	Superficie Finish	Spessore mm Thickness mm
150x150 / 6"x6"	NAT RECT	9
200x300 / 8"x12"	NAT RECT	9
300x300 / 12"x12"	NAT RECT	9
200x600 / 8"x24"	NAT RECT	9
300x600 / 12"x24"	NAT RECT	9
300x600 / 12"x24"	NAT RECT - R12	9
400x600 / 16"x24"	NAT RECT	9
600x600 / 24"x24"	NAT RECT	9
600x1200 / 24"x48"	NAT RECT	9
300x600 / 12"x24"	NAT RECT	20
600x600 / 24"x24"	NAT RECT	20
450x900 / 18"x36"	NAT RECT	20
600x1200 / 24"x48"	NAT RECT	20
Modular 300x600 + 600x900 12"x24" + 24"x36"	NAT RECT	20
600x600 / 24"x24"	NAT RECT	30

Stucchi consigliati Recommended grouts		
KERAKOLL	08	
MAPEI	112 Grigio Medio	
LATICRETE	78 Sterling Silver	

QUARZITI 2.0

RIVER QR 04



Formati Nominali Nominal Sizes	Superficie Finish	Spessore mm Thickness mm
150x150 / 6"x6"	NAT RECT	9
200x300 / 8"x12"	NAT RECT	9
300x300 / 12"x12"	NAT RECT	9
200x600 / 8"x24"	NAT RECT	9
300x600 / 12"x24"	NAT RECT	9
300x600 / 12"x24"	NAT RECT - R12	9
400x600 / 16"x24"	NAT RECT	9
600x600 / 24"x24"	NAT RECT	9
600x1200 / 24"x48"	NAT RECT	9
300x600 / 12"x24"	NAT RECT	20
600x600 / 24"x24"	NAT RECT	20
450x900 / 18"x36"	NAT RECT	20
600x1200 / 24"x48"	NAT RECT	20
600x600 / 24"x24"	NAT RECT	30

Stucchi consigliati Recommended grouts		
KERAKOLL	09	
MAPEI	113 Grigio Cemento	
LATICRETE	34 Sand Stone	

MANTLE QR 05



Formati Nominali Nominal Sizes	Superficie Finish	Spessore mm Thickness mm
150x150 / 6"x6"	NAT RECT	9
200x300 / 8"x12"	NAT RECT	9
300x300 / 12"x12"	NAT RECT	9
200x600 / 8"x24"	NAT RECT	9
300x600 / 12"x24"	NAT RECT	9
300x600 / 12"x24"	NAT RECT - R12	9
400x600 / 16"x24"	NAT RECT	9
600x600 / 24"x24"	NAT RECT	9
600x1200 / 24"x48"	NAT RECT	9
300x600 / 12"x24"	NAT RECT	20
600x600 / 24"x24"	NAT RECT	20
450x900 / 18"x36"	NAT RECT	20
600x1200 / 24"x48"	NAT RECT	20
Modular 300x600 + 600x900 12"x24" + 24"x36"	NAT RECT	20

Stucchi consigliati Recommended grouts		
KERAKOLL	11	
MAPEI	114 Antracite	
LATICRETE	45 Raven	

RIASSUNTIVO FORMATI ED IMBALLI

Summary of sizes and packaging | Übersicht über Formate und Verpackungen | Récapitulatif formats et emballages
Sinóptico de formatos y embalajes | Краткая информация о форматах и упаковках | 规格和包装概述

		± 9 mm								
Formati Nominali Nominal Sizes		150x150 6"x6"	200x300 8"x12"	300x300 12"x12"	200x600 8"x24"	300x600 12"x24"	300x600 12"x24"	400x600 16"x24"	600x600 24"x24"	600x1200 24"x48"
Tutti i formati sono rettificati. All sizes are rectified.										
Superficie Finish		NAT	NAT	NAT	NAT	NAT	NAT R12	NAT	NAT	NAT
	GLACIER QR 01	V3	■	■	■	■	■	■	■	■
	MOUNTAINS QR 02	V3	■	■	■	■	■	■	■	■
	WATERFALL QR 03	V3	■	■	■	■	■	■	■	■
	RIVER QR 04	V3	■	■	■	■	■	■	■	■
	MANTLE QR 05	V3	■	■	■	■	■	■	■	■
	Peso lordo per scatola Gross weight per box	11,24	23,95	22,50	22,62	25,58	25,58	25,75	22,13	30,00
	Pezzi per scatola Pieces for box	28	17	12	8	7	7	5	3	2
	mq. scatola sqm. box	0,63	1,02	1,08	0,96	1,26	1,26	1,20	1,08	1,44
	Scatole / Full pallet boxes / Full pallet	68	51	48	54	40	40	60	40	35
	mq. pallet sqm. pallet	42,84	52,02	51,84	51,84	50,40	50,40	72,00	43,20	50,40

		± 20 mm					± 30 mm
Formati Nominali Nominal Sizes		300x600** 12"x24"	600x600 24"x24"	600x1200 24"x48"	450x900 18"x36"	Modular 300x600 + 600x900 12"x24" + 24"x36"	600x600 24"x24"
Tutti i formati sono rettificati. All sizes are rectified.							
Superficie Finish		NAT	NAT	NAT	NAT	NAT	NAT
	GLACIER QR 01	V3	■	■	■	■	-
	MOUNTAINS QR 02	V3	■	■	■	■	■
	WATERFALL QR 03	V3	■	■	■	■	■
	RIVER QR 04	V3	■	■	■	■	-
	MANTLE QR 05	V3	■	■	■	■	-
	Peso lordo per scatola Gross weight per box	24,58	31,80	30,74	35,60	32,85	23,60
	Pezzi per scatola Pieces for box	3	2	1	2	2 (1 pz 300x600 + 1 pz 600x900)	1
	mq. scatola sqm. box	0,54	0,72	0,72	0,81	0,72	0,36
	Scatole / Full pallet boxes / Full pallet	40	30	35	27	36	40
	mq. pallet sqm. pallet	21,60	21,60	25,20	21,87	25,92	14,40

*I pezzi non sono vendibili separatamente | Pieces cannot be sold separately.
**Formato ricavato dal taglio del 600x600x20 | 600x600x20 cutting size.

PEZZI SPECIALI

Special pieces | Sonderstücke | Pièces spéciales | Piezas especiales | специальные изделия | 特殊件

Pezzi speciali Special pieces		72x600 27"x24"	300x600 12"x24"	330x1200 13 1/2"x48"	300x600 12"x24"	165x300 6 3/5"x12"
Superficie Finish		NAT	NAT	NAT	NAT	NAT
	GLACIER QR 01	■	■	■	■	■
	MOUNTAINS QR 02	■	■	■	■	■
	WATERFALL QR 03	■	■	■	■	■
	RIVER QR 04	■	■	■	■	■
	MANTLE QR 05	■	■	■	■	■
	Pezzi per scatola Pieces for box	10	7	4	7	10

* Finitura a becco di civetta | One-round edge shaping | Ausführung mit Eckabrundung | Façonnage à bord rond | Acabado canto romo | Плитка с завалом | 鹰嘴边缘处理

Pezzi speciali Special pieces		330x330 13 1/2"x13 1/2"	330x600 13 1/2"x24"	330x1200 13 1/2"x48"	300x600x20 12"x24"x3/4"
Superficie Finish		NAT	NAT	NAT	NAT
	GLACIER QR 01	■	■	■	■
	MOUNTAINS QR 02	■	■	■	■
	WATERFALL QR 03	■	■	■	■
	RIVER QR 04	■	■	■	■
	MANTLE QR 05	■	■	■	■
	Pezzi per scatola Pieces for box	4	4	2	3

MY NOTES

.....

.....

.....

.....

.....

Maggiori informazioni
More information



DECORI

Decors | Dekore | Decors | Decoros | Декоры | 装饰砖

Mattoncino NAT
300x300 / 12"x12"
Tessere 24x48 / 1"x2"



GLACIER QR 01 MOUNTAINS QR 02 WATERFALL QR 03 RIVER QR 04 MANTLE QR 05

Rudd NAT (burattato)
300x300 / 12"x12"
Tessere 60x60 / 2 2/8"x2 2/8"

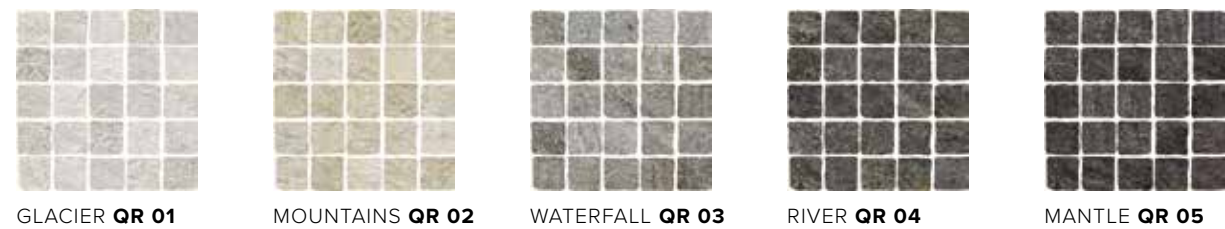

GLACIER QR 01 MOUNTAINS QR 02 WATERFALL QR 03 RIVER QR 04 MANTLE QR 05

Fragment NAT
300x600 / 12"x24"



GLACIER QR 01 MOUNTAINS QR 02 WATERFALL QR 03

Pezzi per scatola
Pieces for box

Mattoncino	6
Rudd	11
Fragment	5

MATTONCINO, RUDD, FRAGMENT:
Decoro su rete | Mesh-backed decoration | Dekor auf netz | Décor sur filet | Decoración en red | Декор в сети | 网板背帖装饰件

NAT: Naturale | Natural | Natur/unpoliert | Naturelle | Natural | Натуральный | 天然

CARATTERISTICHE TECNICHE

Technical specifications | Technische Eigenschaften | Caractéristiques techniques | Características técnicas | Технические характеристики | 技术特征

STANDARD EN 14411 - G

	CARATTERISTICHE TECNICHE TECHNISCHE DATEN TECHNISCHE DATEN CARACTERISTIQUES TECHNIQUES CARACTERÍSTICAS TÉCNICAS ТЕХНИЧЕСКИЕ ХАРАКТЕРИСТИКИ 技术特征	NORMA STANDARD NORM NORME NORMA НОРМА 标准	VALORI PRESCRITTI DALLE NORME EN 14411 - G INTERNATIONAL STANDARDS EN 14411 - G INTERNATIONALE NORMWERTE EN 14411 - G VALEURS PREVUES PAR LES NORMES EN 14411 - G VALORES PREVISTOS POR LAS NORMAS EN 14411 - G ПРЕДУСМОТРЕННЫЕ СТАНДАРТОМ EN 14411-G EN 14411 - G标准规定值	*VALORE MEDIO MIRAGE MIRAGE AVERAGE VALUE MIRAGE MITTELWERT VALEURS MOYEN MIRAGE VALOR MEDIO MIRAGE СРЕДНЕЕ ЗНАЧЕНИЕ MIRAGE MIRAGE平均值	
	CARATTERISTICHE DIMENSIONALI - SIZE CHARACTERISTICS - MASSEIGENSCHAFTEN DETERMINATION DES CARACTERISTIQUES DIMENSIONNELLES - CARACTERÍSTICAS DIMENSIONALES - РАЗМЕРНЫЕ ХАРАКТЕРИСТИКИ - 尺寸特征				
	LATI SIDES - SEITEN COTES - CANTOS РАЗМЕРЫ СТОРОН - 侧边	EN ISO 10545-2	± 0,3% MAX (± 1,0 mm MAX)	CONFORME COMPLYING	
	SPESSORE THICKNESS - DICKE EPAISSEUR - ESPESOR ТОЛЩИНА - 厚度	EN ISO 10545-2	± 5,0% MAX (± 0,5 mm MAX)	CONFORME COMPLYING	
	RETTILINEITÀ DEGLI SPIGOLI STRAIGHTNESS OF SIDES - GERADLINIGKEIT DER KANTEN RECTITUDE DES ARETES - RECTITUD DE LOS CANTOS КОСОУГОЛЬНОСТЬ - 边角平直度	EN ISO 10545-2	± 0,3% MAX (± 0,8 mm MAX)	CONFORME COMPLYING	
	ORTOGONALITÀ RECTANGULARITY - RECHTWINKLIGKEIT PERPENDICULARITÉ - ORTOGONALIDAD КРИВИЗНА СТОРОН - 直角度	EN ISO 10545-2	± 0,3% MAX (± 1,5 mm MAX)	CONFORME COMPLYING	
	PLANARITÀ SURFACE FLATNESS - EBENFLÄCHIGKEIT PLANEITE DE SURFACE - PLANEIDAD КРИВИЗНА ЛИЦЕВОЙ ПОВЕРХНОСТИ - 平整度	EN ISO 10545-2	± 0,4% MAX (± 1,8 mm MAX)	CONFORME COMPLYING	
	ASSORBIMENTO D'ACQUA WATER ABSORPTION - WASSERAUFNAHME ABSORPTION D'EAU - ABSORCIÓN DE AGUA ВОДОПОГЛОЩЕНИЕ - 吸水率	EN ISO 10545-3	≤ 0,5%	≤ 0,1%	
	RESISTENZA ALLA FLESSIONE FLEXION RESISTANCE - BIEGEFESTIGKEIT RESISTANCE A LA FLEXION - RESISTENCIA A LA FLEXIÓN ПРЕДЕЛ ПРОЧНОСТИ ПРИ ИЗГИБЕ - 抗弯强度	EN ISO 10545-4	S ≥ 700 N (< 7,5 mm) S ≥ 1.300 N (> 7,5 mm) R ≥ 35 N/mm².	≠9 mm: S≥2400N R≥48N/mm² ≠20 mm: S≥12.500N R≥48N/mm² ≠30 mm: S≥26.000N R≥48N/mm²	
	RESISTENZA ALL'URTO IMPACT RESISTANCE - STOSSFESTIGKEIT RESISTANCE AUX CHOCS - RESISTENCIA A LOS GOLPES УДАРОСТОЙКОСТЬ - 抗冲击强度	EN ISO 10545-5	VALORE DICHIARATO DECLARED VALUE	> 0,80	
	RESISTENZA ALL'ABRASIONE ABRASION RESISTANCE - ABRIEBFESTIGKEIT RESISTANCE A L'ABRASION - RESISTENCIA A LA ABRASIÓN СТОЙКОСТЬ К ИСТИРАНИЮ - 耐磨强度	EN ISO 10545-6	≤ 175 mm³	< 150 mm³	
	COEFFICIENTE DI DILATAZIONE TERMICA LINEARE COEFFICIENT OF LINEAR THERMAL-EXPANSION - LINEARER WÄRMEAUSSDEHNUNGSKOEFFIZIENT COEFFICIENT DE DILATATION THERMIQUE LINEAIRE - COEFICIENTE DE DILATACIÓN TÉRMICA LINEAL КОЭФФИЦИЕНТ ЛИНЕЙНОГО ТЕРМИЧЕСКОГО РАСТЯЖЕНИЯ - 线性热膨胀系数	EN ISO 10545-8	-	α=7x10 ⁻⁶ °C ⁻¹	
	RESISTENZA AGLI SBALZI TERMICI RESISTANCE TO THERMAL SHOCKS - BESTÄNDIGKEIT GEGEN TEMPERATURSCHWANKUNGEN RESISTANCE AUX CHOCS THERMIQUES - RESISTENCIA A LOS CHOQUES TÉRMICOS СТОЙКОСТЬ К ПЕРЕПАДАМ ТЕМПЕРАТУРЫ - 耐热突变性	EN ISO 10545-9	TEST SUPERATO SECONDO EN ISO 10545-1 PASS ACCORDING EN ISO 10545-1	NESSUN DANNO NO DAMAGE	
	RESISTENZA AL GELO FROST RESISTANCE - FROSTBESTÄNDIGKEIT RESISTANCE AU GEL - RESISTENCIA AL HIELO МОРОЗОСТОЙКОСТЬ - 耐冻性	EN ISO 10545-12	TEST SUPERATO SECONDO EN ISO 10545-1 PASS ACCORDING EN ISO 10545-1	NESSUN DANNO NO DAMAGE	
	RESISTENZA ALL'ATTACCO CHIMICO RESISTANCE TO CHEMICALS - CHEMIKALIENBESTÄNDIGKEIT RESISTANCE A L'ATTAQUE CHIMIQUE - RESISTENCIA QUÍMICA ХИМИЧЕСКАЯ СТОЙКОСТЬ - 耐化学作用	EN ISO 10545-13	UB MIN.	A LA HA	
	RESISTENZA ALLE MACCHIE RESISTANCE TO STAINS - FLECKENBESTÄNDIGKEIT RESISTANCE AUX TACHES - RESISTENCIA A LAS MANCHAS УСТОЙЧИВОСТЬ К ПЯТНООБРАЗОВАНИЮ - 防污性	EN ISO 10545-14	VALORE DICHIARATO DECLARED VALUE	5	
	CESSIONE DI PIOMBO E CADMIO LEAD AND CADMIUM DISCHARGE - ABGABE VON BLEI UND CADMIUM PERTE DE PLOMB ET CADMIUM - CESIÓN DE PLOMO Y CADMIO ВЫДЕЛЕНИЕ СВИНЦА И КАДМИЯ - 铅和镉的排放	EN ISO 10545-15	VALORE DICHIARATO DECLARED VALUE	< AL LIMITE DI RILEVAMENTO < THAN INSTRUMENT LIMIT	
			NAT	300x600 NAT R12	NAT 20 mm NAT 30 mm
	DM 236/89 BCRA	> 0,40	> 0,40	> 0,40	> 0,40
	ANSI A326.3	Wet and Dry	≥ 0,42	≥ 0,55	≥ 0,55
	AS 4586	-	P3	P5	P5
	DIN 51130	-	R10	R12	R11
	DIN 51097	-	A+B	A+B+C	A+B
	UNE 41901	≥ CL1	CL2	CL3	CL3
	BS 7976 sl.96-4S	Wet and Dry	≥ 0,36	≥ 0,36	≥ 0,36
	BS 7976 sl.55-TRL	Wet and Dry	≥ 0,36	≥ 0,36	≥ 0,36

SCIVOLOSITÀ
SKID RESISTANCE - RUTSCHWERT
GLISSANCE - ADHERENCIA
СКОЛЬЗКОСТЬ - 防滑性

Per i certificati specifici, contattare Mirage SpA - For specific certificates, please contact Mirage SPA - Für die speziellen Zertifikate wenden Sie sich bitte an Mirage SpA - Pour les certificats spécifiques, veuillez contacter Mirage SPA
Para los certificados específicos, contactar Mirage SPA - Для сертификатов обращайтесь в компанию Mirage SpA - 关于具体的证书, 请联系Mirage SpA公司



Graphite **RL 02** 300x1200 / 12"x48" RD RECT EVO_2/E" 20 mm

RAIL

Easy maintenance, resistant to wear and weathering.

Rail is the perfect collection for public and private outdoor living.



Iceberg **RL 01** 300x1200 / 12"x48" RD RECT EVO_2/E" 20 mm



COLORI
Colours | Farben | Couleurs | Colores | Цветов | 种颜色



Iceberg
RL 01



Graphite
RL 02









FLOOR: Graphite **RL 02** - 300x1200 / 12"x48" RD RECT EVO_2/E" ± 20 mm | Graphite **RL 02** - Special pieces for pools

COLORI

Colours | Farben | Couleurs | Colores | Цветов | 种颜色

ICEBERG RL 01









 Formati Nominali Nominal Sizes	 Superficie Finish	 Spessore mm Thickness mm
 300x1200 / 12"x48"	RD RECT	20
 Stucchi consigliati Recommended grouts		
KERAKOLL	06	
MAPEI	110 Manhattan	
LATICRETE	89 Smoke Grey	



GRAPHITE RL 02



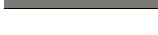









 Formati Nominali Nominal Sizes	 Superficie Finish	 Spessore mm Thickness mm
 300x1200 / 12"x48"	RD RECT	20
 Stucchi consigliati Recommended grouts		
KERAKOLL	09	
MAPEI	113 Grigio Cemento	
LATICRETE	34 Sand Stone	



RIASSUNTIVO FORMATI ED IMBALLI

Summary of sizes and packaging | Übersicht über Formate und Verpackungen | Récapitulatif formats et emballages
Sinóptico de formatos y embalajes | Краткая информация о форматах и упаковках | 规格和包装概述

		GO 2/e ± 20 mm
 Formati Nominali Nominal Sizes	300x1200 12"x48"	
Tutti i formati sono rettificati. All sizes are rectified.		
 Superficie Finish	RD	
 ICEBERG RL 01	V2	
 GRAPHITE RL 02	V2	
 Peso lordo per scatola Gross weight per box	32,00	
 Pezzi per scatola Pieces for box	2	
 mq. scatola sqm. box	0,72	
 Scatole / Full pallet boxes / Full pallet	36	
 mq. pallet sqm. pallet	25,92	

MY NOTES

.....

.....

.....

.....

.....

 **Maggiori informazioni**
More information





CARATTERISTICHE TECNICHE

Technical specifications | Technische Eigenschaften | Caractéristiques techniques | Características técnicas | Технические характеристики | 技术特征

STANDARD EN 14411 - G

	CARATTERISTICHE TECNICHE TECHNICAL DATA TECHNISCHE DATEN CARACTERISTIQUES TECHNIQUES CARACTERÍSTICAS TÉCNICAS ТЕХНИЧЕСКИЕ ХАРАКТЕРИСТИКИ 技术特征	NORMA STANDARD NORM NORME NORMA ЗНАЧЕНИЯ 标准	VALORI PRESCRITTI DALLE NORME EN 14411 - G INTERNATIONAL STANDARDS EN 14411 - G INTERNATIONALE NORMWERTE EN 14411 - G VALEURS PREVUES PAR LES NORMES EN 14411 - G VALORES PREVISTOS POR LAS NORMAS EN 14411 - G ПРЕДУСМОТРЕННЫЕ СТАНДАРТОВ EN 14411-G EN 14411 - G标准规定值	*VALORE MEDIO MIRAGE MIRAGE AVERAGE VALUE MIRAGE MITTELWERT VALEURS MOYEN MIRAGE VALOR MEDIO MIRAGE СРЕДНЕЕ ЗНАЧЕНИЕ MIRAGE MIRAGE平均值
	CARATTERISTICHE DIMENSIONALI - SIZE CHARACTERISTICS - MASSEIGENSCHAFTEN DETERMINATION DES CARACTERISTIQUES DIMENSIONNELLES - CARACTERÍSTICAS DIMENSIONALES - РАЗМЕРНЫЕ ХАРАКТЕРИСТИКИ - 尺寸特征			
	LATI SIDES - SEITEN COTES - CANTOS РАЗМЕРЫ СТОРОН - 側邊	EN ISO 10545-2	± 0,3% MAX (± 1,0 mm MAX)	CONFORME COMPLYING
	SPESORE THICKNESS - DICKE EPAISSEUR - ESPESOR ТОЛЩИНА - 厚度	EN ISO 10545-2	± 5,0% MAX (± 0,5 mm MAX)	CONFORME COMPLYING
	RETTILINEITÀ DEGLI SPIGOLI STRAIGHTNESS OF SIDES - GERADLINIGKEIT DER KANTEN RECTITUDE DES ARETES - RECTITUD DE LOS CANTOS КОСОУГОЛЬНОСТЬ - 边角平直度	EN ISO 10545-2	± 0,3% MAX (± 0,8 mm MAX)	CONFORME COMPLYING
	ORTOGONALITÀ RECTANGULARITY - RECHTWINKLIGKEIT PERPENDICULARITÉ - ORTOGONALIDAD КРИВИЗНА СТОРОН - 直角度	EN ISO 10545-2	± 0,3% MAX (± 1,5 mm MAX)	CONFORME COMPLYING
	PLANARITÀ SURFACE FLATNESS - EBENFLÄCHIGKEIT PLANEITE DE SURFACE - PLANEIDAD КРИВИЗНА ЛИЦЕВОЙ ПОВЕРХНОСТИ - 平整度	EN ISO 10545-2	± 0,4% MAX (± 1,8 mm MAX)	CONFORME COMPLYING
	ASSORBIMENTO D'ACQUA WATER ABSORPTION - WASSERAUFNAHME ABSORPTION D'EAU - ABSORCIÓN DE AGUA ВОДОПОГЛОЩЕНИЕ - 吸水率	EN ISO 10545-3	≤ 0,5%	≤ 0,1%
	RESISTENZA ALLA FLESSIONE FLEXION RESISTANCE - BIEGEFESTIGKEIT RESISTANCE A LA FLEXION - RESISTENCIA A LA FLEXIÓN ПРЕДЕЛ ПРОЧНОСТИ ПРИ ИЗГИБЕ - 抗弯强度	EN ISO 10545-4	S ≥ 700 N (< 7,5 mm) S ≥ 1.300 N (> 7,5 mm) R ≥ 35 N/mm².	≥ 20 mm: S ≥ 12.500 N R ≥ 48 N/mm²
	RESISTENZA ALL'URTO IMPACT RESISTANCE - STOSSFESTIGKEIT RESISTANCE AUX CHOCS - RESISTENCIA A LOS GOLPES УДАРОСТОЙКОСТЬ - 抗冲击强度	EN ISO 10545-5	VALORE DICHIARATO DECLARED VALUE	> 0,80
	RESISTENZA ALL'ABRAZIONE ABRASION RESISTANCE - ABRIEFESTIGKEIT RESISTANCE A L'ABRASION - RESISTENCIA A LA ABRASIÓN СТОЙКОСТЬ К ИСТИРАНИЮ - 耐磨强度	EN ISO 10545-6	≤ 175 mm³	< 150 mm³
	COEFFICIENTE DI DILATAZIONE TERMICA LINEARE COEFFICIENT OF LINEAR THERMAL-EXPANSION - LINEARER WÄRMEAUDEHNUNGSKOEFFIZIENT COEFFICIENT DE DILATATION THERMIQUE LINEAIRE - COEFICIENTE DE DILATACIÓN TÉRMICA LINEAL КОЭФИЦИЕНТ ЛИНЕЙНОГО ТЕРМИЧЕСКОГО РАСШИРЕНИЯ - 线性热膨胀系数	EN ISO 10545-8	-	α=6,3x10 ⁻⁶ °C ⁻¹
	RESISTENZA AGLI SBALZI TERMICI RESISTANCE TO THERMAL SHOCKS - BESTÄNDIGKEIT GEGEN TEMPERATURSCHWANKUNGEN RESISTANCE AUX CHOCS THERMIQUES - RESISTENCIA A LOS CHOQUES TÉRMICOS СТОЙКОСТЬ К ПЕРЕПАДАМ ТЕМПЕРАТУРЫ - 耐热突变性	EN ISO 10545-9	TEST SUPERATO SECONDO EN ISO 10545-1 PASS ACCORDING EN ISO 10545-1	NESSUN DANNO NO DAMAGE
	RESISTENZA AL GELO FROST RESISTANCE - FROSTBESTÄNDIGKEIT RESISTANCE AU GEL - RESISTENCIA AL HIELO МОРОЗОСТОЙКОСТЬ - 耐冻性	EN ISO 10545-12	TEST SUPERATO SECONDO EN ISO 10545-1 PASS ACCORDING EN ISO 10545-1	NESSUN DANNO NO DAMAGE
	RESISTENZA ALL'ATTACCO CHIMICO RESISTANCE TO CHEMICALS - CHEMIKALIENBESTÄNDIGKEIT RESISTANCE A L'ATTAQUE CHIMIQUE - RESISTENCIA QUÍMICA ХИМИЧЕСКАЯ СТОЙКОСТЬ - 耐化学品作用	EN ISO 10545-13	B MIN.	A LA HA
	RESISTENZA ALLE MACCHIE RESISTANCE TO STAINS - FLECKENBESTÄNDIGKEIT RESISTANCE AUX TACHES - RESISTENCIA A LAS MANCHAS УСТОЙЧИВОСТЬ К ПЯТНООБРАЗОВАНИЮ - 防污性	EN ISO 10545-14	VALORE DICHIARATO DECLARED VALUE	5
	CESSIONE DI PIOMBO E CADMIO LEAD AND CADMIUM DISCHARGE - ABGABE VON BLEI UND CADMIUM PERTE DE PLOMB ET CADMIUM - CESIÓN DE PLOMO Y CADMIO ВЫДЕЛЕНИЕ СВИНЦА И КАДМИЯ - 铅和镉的排放	EN ISO 10545-15	VALORE DICHIARATO DECLARED VALUE	< AL LIMITE DI RILEVAMENTO < THAN INSTRUMENT LIMIT
				RD 20mm
			DM 236/89 BCRA	> 0,40
			ANSI A326.3	Wet and Dry
			AS 4586	-
			DIN 51130	-
			DIN 51097	-
			UNE 41901	≥ CL1
			BS 7976 sl.96-4S	Wet and Dry
			BS 7976 sl.55-TRL	Wet and Dry
	SCIVOLOSITÀ SKID RESISTANCE - RUTSCHWERT GLISSANCE - ADHERENCIA СКОЛЬЗКОСТЬ - 防滑性			≥ 0,40
				≥ 0,55
				P4
				R11
				A+B+C
				CL3
				≥ 0,36
				≥ 0,36

Iceberg RL 01 300x1200 / 12"x48" RD RECT EVO_2/E" ± 20 mm

Per i certificati specifici, contattare Mirage SpA - For specific certificates, please contact Mirage SpA - Für die speziellen Zertifikate wenden Sie sich bitte an Mirage SpA - Pour les certificats spécifiques, veuillez contacter Mirage SpA
Para los certificados específicos, contactar Mirage SpA - Для сертификатов обращайтесь в компанию Mirage SpA - 关于具体的证书, 请联系Mirage SpA公司



WALL: Midi **RF 02** 200x600 / 8"x24" SKETCH
 FLOOR: JOLIE Pietra Grey **JL 06** 800x800 / 31½"x31½" SP RECT
 COUNTER: Midi **RF 02** 200x600 / 8"x24" ANTIQUE

REFLET

With the collaboration of
Andrea Boschetti

The magic of reflection with REFLET, the mirroring collection in porcelain stoneware suitable for indoor and outdoor environments. An innovative material in three different shades, making it possible to express infinite aspects of the relationship between architecture, nature and places in which it is located.



WALL: Aurore **RF 03** 200x600 / 8"x24" ANTIQUE + WANDERLUST Saint Laurent **WA 07** 1200x2780 / 48"x110" LUC RECT
 FLOOR: WANDERLUST Saint Laurent **WA 07** 1200x2780 / 48"x110" LUC RECT
 VANITY TOP: WANDERLUST Calacatta Copper **WA 01** LUC



WALL: Portland **NY 02** 1200x2780 / 48"x110" SP RECT + REFLET Aurore **RF 03** 200x600 / 8"x24" ANTIQUE
FLOOR: Portland **NY 02** 1200x1200 / 48"x48" NAT RECT

COLORI

Colours | Farben | Couleurs | Colores | Цветов | 种颜色



Soirée
RF 01



Midi
RF 02



Aurore
RF 03



WALL & COUNTER: Portland **NY 02** 1200x2780 / 48"x110" SP RECT + REFLET Aurore **RF 03** 200x600 / 8"x24" ANTIQUE
FLOOR: Portland **NY 02** 1200x1200 / 48"x48" NAT RECT



WALL: Soirée **RF 01** 200x600 / 8"x24" ANTIQUE
FLOOR: NYUMA Torching **NY 03** 800x800 / 31½"x31½" ST RECT EVO_2/E" ± 20 mm



WALL: Midi **RF 02** 200x600 / 8"x24" SKETCH
FLOOR: JOLIE Pietra Grey **JL 06** 800x800 / 31½"x31½" SP RECT

COLORI

Colours | Farben | Couleurs | Colores | Цветов | 种颜色

SOIRÉE RF 01



ANTIQUÉ

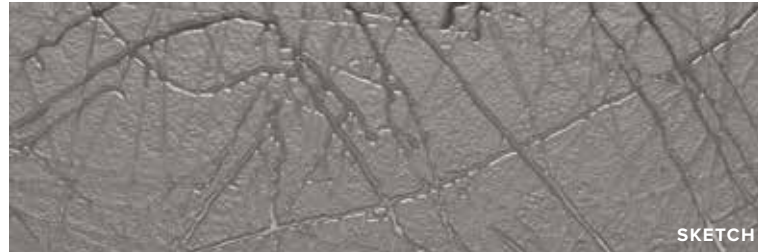

SKETCH

	Formati Nominali		Superficie		Spessore mm
	Nominal Sizes		Finish		Thickness mm
	200x600 / 8"x24"		ANTIQUÉ		9
	200x600 / 8"x24"		SKETCH		9

	Stucchi consigliati		
	Recommended grouts		
	KERAKOLL	09	
	MAPEI	113 Grigio Cemento	
LATICRETE	34 Sand Stone		



MIDI RF 02



ANTIQUÉ

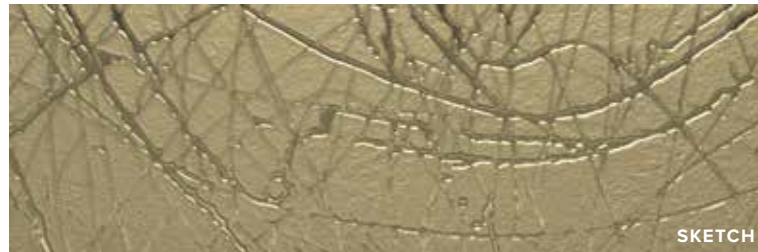

SKETCH

	Formati Nominali		Superficie		Spessore mm
	Nominal Sizes		Finish		Thickness mm
	200x600 / 8"x24"		ANTIQUÉ		9
	200x600 / 8"x24"		SKETCH		9

	Stucchi consigliati		
	Recommended grouts		
	KERAKOLL	26	
	MAPEI	133	
LATICRETE	40 Latte		



AUORE RF 03



ANTIQUÉ

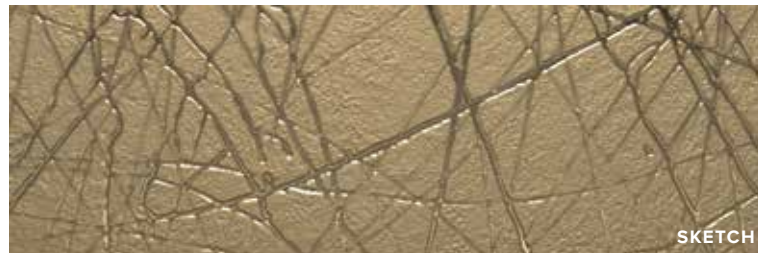

SKETCH

	Formati Nominali		Superficie		Spessore mm
	Nominal Sizes		Finish		Thickness mm
	200x600 / 8"x24"		ANTIQUÉ		9
	200x600 / 8"x24"		SKETCH		9

	Stucchi consigliati		
	Recommended grouts		
	KERAKOLL	26	
	MAPEI	136	
LATICRETE	30 Sand Beige		



RIASSUNTIVO FORMATI ED IMBALLI

Summary of sizes and packaging | Übersicht über Formate und Verpackungen | Récapitulatif formats et emballages
Sinóptico de formatos y embalajes | Краткая информация о форматах и упаковках | 规格和包装概述

		9 mm	
	Formati Nominali	200x600	
	Nominal Sizes	8"x24"	
	Superficie	ANTIQUÉ	SKETCH
	Finish		
	SOIRÉE RF 01	■	■
	MIDI RF 02	■	■
	AUORE RF 03	■	■
	Pezzi per scatola	4	4
	Pieces for box		

PRODOTTO ADATTO ESCLUSIVAMENTE PER L'APPLICAZIONE A RIVESTIMENTO. | Ausschließlich für die Anwendung als Wandverkleidung geeignetes Produkt. | Produit adapté exclusivement à une application en revêtement. | Producto solo apto para aplicación como revestimiento. | Продукт, подходящий для применения в качестве настенной облицовки | 产品只适用于墙体应用。

DECORI

Decors | Dekore | Decors | Decoros | Декоры | 装饰砖

Mosaico 144T ANTIQUÉ / SKETCH
300x300 / 12"x12"
Tessere 22x22 / 4/5"x4/5"

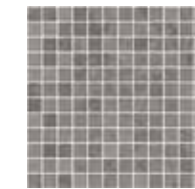

SOIRÉE RF 01 ANTIQUÉ

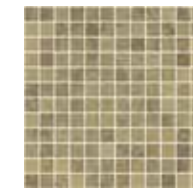

MIDI RF 02 ANTIQUÉ

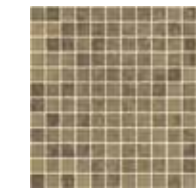

AUORE RF 03 ANTIQUÉ

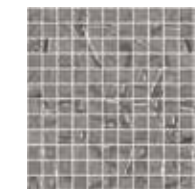

SOIRÉE RF 01 SKETCH



MIDI RF 02 SKETCH



AUORE RF 03 SKETCH

	Pezzi per scatola	
	Pieces for box	
	Mosaico 144T	6

PRODOTTO ADATTO ESCLUSIVAMENTE PER L'APPLICAZIONE A RIVESTIMENTO. | Ausschließlich für die Anwendung als Wandverkleidung geeignetes Produkt. | Produit adapté exclusivement à une application en revêtement. | Producto solo apto para aplicación como revestimiento. | Продукт, подходящий для применения в качестве настенной облицовки | 产品只适用于墙体应用。

MY NOTES

.....

.....

.....

.....

.....

Maggiori informazioni
More information





WALL: Aurore **RF 03** 200x600 / 8"x24" ANTIQUE
 VANITY TOP: WANDERLUST Calacatta Copper **WA 01** LUC

CARATTERISTICHE TECNICHE

Technical specifications | Technische Eigenschaften | Caractéristiques techniques | Características técnicas | Технические характеристики | 技术特征

STANDARD EN 14411 - G

	CARATTERISTICHE TECNICHE TECHNICAL DATA TECHNISCHE DATEN CARACTERISTIQUES TECHNIQUES CARACTERÍSTICAS TÉCNICAS ТЕХНИЧЕСКИЕ ХАРАКТЕРИСТИКИ 技术特征	NORMA STANDARD NORM NORME NORMA НОРМА СТАНДАРТ	VALORI PRESCRITTI DALLE NORME EN 14411 - G INTERNATIONAL STANDARDS EN 14411 - G INTERNATIONALE NORMWERTE EN 14411 - G VALEURS PREVUES PAR LES NORMES EN 14411 - G VALORES PREVISTOS POR LAS NORMAS EN 14411 - G ПРЕДУСМОТРЕННЫЕ СТАНДАРТЫ EN 14411-G EN 14411 - G标准规定值	*VALORE MEDIO MIRAGE MIRAGE AVERAGE VALUE MIRAGE MITTELWERT VALEURS MOYEN MIRAGE VALOR MEDIO MIRAGE СРЕДНЕЕ ЗНАЧЕНИЕ MIRAGE MIRAGE平均值
	CARATTERISTICHE DIMENSIONALI - SIZE CHARACTERISTICS - MASSEIGENSCHAFTEN DETERMINATION DES CARACTERISTIQUES DIMENSIONNELLES - CARACTERÍSTICAS DIMENSIONALES - РАЗМЕРНЫЕ ХАРАКТЕРИСТИКИ - 尺寸特征			NAT
	LATI SIDES - SEITEN COTES - CANTOS РАЗМЕРЫ СТОРОН - 側边	EN ISO 10545-2	± 0,3% MAX (± 1,0 mm MAX)	CONFORME COMPLYING
	SPESSORE THICKNESS - DICKE EPAISSEUR - ESPESOR ТОЛЩИНА - 厚度	EN ISO 10545-2	± 5,0% MAX (± 0,5 mm MAX)	CONFORME COMPLYING
	RETTILINEITÀ DEGLI SPIGOLI STRAIGHTNESS OF SIDES - GERADLINIGKEIT DER KANTEN RECTITUDE DES ARETES - RECTITUD DE LOS CANTOS КОСОУГОЛЬНОСТЬ - 边角平直度	EN ISO 10545-2	± 0,3% MAX (± 0,8 mm MAX)	CONFORME COMPLYING
	ORTOGONALITÀ RECTANGULARITY - RECHTWINKLIGKEIT PERPENDICULARITÉ - ORTOGONALIDAD КРИВИЗНА СТОРОН - 直角度	EN ISO 10545-2	± 0,3% MAX (± 1,5 mm MAX)	CONFORME COMPLYING
	PLANARITÀ SURFACE FLATNESS - EBENFLÄCHIGKEIT PLANEITE DE SURFACE - PLANEIDAD КРИВИЗНА ЛИЦЕВОЙ ПОВЕРХНОСТИ - 平整度	EN ISO 10545-2	± 0,4% MAX (± 1,8 mm MAX)	CONFORME COMPLYING
	ASSORBIMENTO D'ACQUA WATER ABSORPTION - WASSERAUFNAHME ABSORPTION D'EAU - ABSORCIÓN DE AGUA ВОДОПОГЛОЩЕНИЕ - 吸水率	EN ISO 10545-3	≤ 0,5%	≤ 0,1%
	RESISTENZA ALLA FLESSIONE FLEXION RESISTANCE - BIEGEFESTIGKEIT RESISTANCE A LA FLEXION - RESISTENCIA A LA FLEXIÓN ПРЕДЕЛ ПРОЧНОСТИ ПРИ ИЗГИБЕ - 抗弯强度	EN ISO 10545-4	S ≥ 700 N (< 7,5 mm) S ≥ 1.300 N (> 7,5 mm) R ≥ 35 N/mm².	≠ 9 mm: S ≥ 2.400 N R ≥ 48 N/mm²
	RESISTENZA ALL'URTO IMPACT RESISTANCE - STOSSFESTIGKEIT RESISTANCE AUX CHOCES - RESISTENCIA A LOS GOLPES УДАРСТОЙКОСТЬ - 抗冲击强度	EN ISO 10545-5	VALORE DICHIARATO DECLARED VALUE	> 0,80
	RESISTENZA ALL'ABRASIONE SUPERFICIALE SURFACE ABRASION RESISTANCE - ABRIEBFESTIGKEIT DER OBERFLÄCHE RESISTANCE À L'ABRASION SUPERFICIELLE - RESISTENCIA A LA ABRASIÓN SUPERFICIAL ХИМИЧЕСКАЯ СТОЙКОСТЬ - 耐表面磨损	EN ISO 10545-7	≤ 175 mm³	PEI 2
	COEFFICIENTE DI DILATAZIONE TERMICA LINEARE COEFFICIENT OF LINEAR THERMAL-EXPANSION - LINEARER WÄRMEAUSSDEHNUNGSKOEFFIZIENT COEFFICIENT DE DILATATION THERMIQUE LINEAIRE - COEFICIENTE DE DILATACIÓN TÉRMICA LINEAL КОЭФФИЦИЕНТ ЛИНЕЙНОГО ТЕРМИЧЕСКОГО РАСШИРЕНИЯ - 线性热膨胀系数	EN ISO 10545-8	—	α=6,6x10 ⁻⁶ °C ⁻¹
	RESISTENZA AGLI SBALZI TERMICI RESISTANCE TO THERMAL SHOCKS - BESTÄNDIGKEIT GEGEN TEMPERATURSCHWANKUNGEN RESISTANCE AUX CHOCES THERMIQUES - RESISTENCIA A LOS CHOQUES TÉRMICOS СТОЙКОСТЬ К ПЕРЕПАДАМ ТЕМПЕРАТУРЫ - 耐热突变性	EN ISO 10545-9	TEST SUPERATO SECONDO EN ISO 10545-1 PASS ACCORDING EN ISO 10545-1	NESSUN DANNO NO DAMAGE
	RESISTENZA AL GELO FROST RESISTANCE - FROSTBESTÄNDIGKEIT RESISTANCE AU GEL - RESISTENCIA AL HIELO МОРОЗОСТОЙКОСТЬ - 耐冻性	EN ISO 10545-12	TEST SUPERATO SECONDO EN ISO 10545-1 PASS ACCORDING EN ISO 10545-1	NESSUN DANNO NO DAMAGE
	RESISTENZA ALL'ATTACCO CHIMICO RESISTANCE TO CHEMICALS - CHEMIKALIENBESTÄNDIGKEIT RESISTANCE A L'ATTAQUE CHIMIQUE - RESISTENCIA QUÍMICA ХИМИЧЕСКАЯ СТОЙКОСТЬ - 耐化学品作用	EN ISO 10545-13	UB MIN.	A
	RESISTENZA ALLE MACCHIE RESISTANCE TO STAINS - FLECKENBESTÄNDIGKEIT RESISTANCE AUX TACHES - RESISTENCIA A LAS MANCHAS УСТОЙЧИВОСТЬ К ПЯТНООБРАЗОВАНИЮ - 防污性	EN ISO 10545-14	VALORE DICHIARATO DECLARED VALUE	5
	CESSIONE DI PIOMBO E CADMIO LEAD AND CADMIUM DISCHARGE - ABGABE VON BLEI UND CADMIUM PERTE DE PLOMB ET CADMIUM - CESIÓN DE PLOMO Y CADMIO ВЫДЕЛЕНИЕ СВИНЦА И КАДМИЯ - 铅和镉的排放	EN ISO 10545-15	VALORE DICHIARATO DECLARED VALUE	< AL LIMITE DI RILEVAMENTO < THAN INSTRUMENT LIMIT

Per i certificati specifici, contattare Mirage SpA - For specific certificates, please contact Mirage SpA - Für die speziellen Zertifikate wenden Sie sich bitte an Mirage SpA - Pour les certificats spécifiques, veuillez contacter Mirage SpA
 Para los certificados específicos, contactar Mirage SpA - Для сертификатов обращайтесь в компанию Mirage SpA - 关于具体的证书, 请联系 Mirage SpA 公司



Dakota **SI 05** 200x1200 / 8"x48" NAT RECT

SIGNATURE

NUANCES, GNARLS and TACTILE touch of wood floors combined with excellent technical features.

Signature does not require any special treatment during and after installation: functionality and reliability in a single product.



Havana **SI 04** 200x1200 / 8"x48" NAT RECT



Artico **SI 01** 200x1200 / 8"x48" NAT RECT

COLORI

Colours | Farben | Couleurs | Colores | Цветов | 种颜色



Artico
SI 01



Magnolia
SI 02



Alpine
SI 03



Havana
SI 04









Dakota
SI 05

COLORI

Colours | Farben | Couleurs | Colores | Цветов | 种颜色







ARTICO SI 01



	Formati Nominali Nominal Sizes 200x1200 / 8"x48"		Superficie Finish NAT RECT		Spessore mm Thickness mm 9	 
	Stucchi consigliati Recommended grouts					
	KERAKOLL	06				
	MAPEI	110 Manhattan				
	LATICRETE	89 Smoke Grey				







MAGNOLIA SI 02



	Formati Nominali Nominal Sizes 200x1200 / 8"x48"		Superficie Finish NAT RECT		Spessore mm Thickness mm 9	 
	Stucchi consigliati Recommended grouts					
	KERAKOLL	07				
	MAPEI	111 Grigio Argento				
	LATICRETE	88 Silver Shadow				







ALPINE SI 03



	Formati Nominali Nominal Sizes 200x1200 / 8"x48"		Superficie Finish NAT RECT		Spessore mm Thickness mm 9	 
	Stucchi consigliati Recommended grouts					
	KERAKOLL	06				
	MAPEI	110 Manhattan				
	LATICRETE	89 Smoke Grey				







HAVANA SI 04



	Formati Nominali Nominal Sizes 200x1200 / 8"x48"		Superficie Finish NAT RECT		Spessore mm Thickness mm 9	  
	Stucchi consigliati Recommended grouts					
	KERAKOLL	08				
	MAPEI	112 Grigio Medio				
	LATICRETE	78 Sterling Silver				

DAKOTA SI 05



	Formati Nominali Nominal Sizes 200x1200 / 8"x48"		Superficie Finish NAT RECT		Spessore mm Thickness mm 9	  
	Stucchi consigliati Recommended grouts					
	KERAKOLL	11				
	MAPEI	114 Antracite				
	LATICRETE	45 Raven				

MY NOTES

.....

.....

.....

.....













.....

 **Maggiori informazioni**
More information













RIASSUNTIVO FORMATI ED IMBALLI

Summary of sizes and packaging | Übersicht über Formate und Verpackungen | Récapitulatif formats et emballages
Sinóptico de formatos y embalajes | Краткая информация о форматах и упаковках | 规格和包装概述

		9 mm
	Formati Nominali Nominal Sizes	200x1200 8"x48"
Tutti i formati sono rettificati. All sizes are rectified.		
	Superficie Finish	NAT
	ARTICO SI 01	V2 ■
	MAGNOLIA SI 02	V2 ■
	ALPINE SI 03	V2 ■
	HAVANA SI 04	V2 ■
	DAKOTA SI 05	V2 ■
	Peso lordo per scatola Gross weight per box	30,92
	Pezzi per scatola Pieces for box	6
	mq. scatola sqm. box	1,44
	Scatole / Full pallet boxes / Full pallet	32
	mq. pallet sqm. pallet	46,08

PEZZI SPECIALI

Special pieces | Sonderstücke | Pièces spéciales | Piezas especiales | специальные изделия | 特殊件

		
	Battiscopa*	Gradino A*
	Pezzi speciali Special pieces	72x600 27 1/8"x24"
	Superficie Finish	NAT
	ARTICO SI 01	■
	MAGNOLIA SI 02	■
	ALPINE SI 03	■
	HAVANA SI 04	■
	DAKOTA SI 05	■
	Pezzi per scatola Pieces for box	10

* **Finitura a becco di civetta** | One-round edge shaping | Ausführung mit Eckabrundung | Façonnage à bord rond | Acabado canto romo | Плитка с завалом | 鹰嘴边缘处理

DECORI

Decors | Dekore | Decors | Decoros | Декоры | 装饰砖

 **Stick NAT**
300x600 / 12"x24"
Tessere 10x600 / 3/8"x24"



ARTICO SI 01



MAGNOLIA SI 02



ALPINE SI 03



HAVANA SI 04



DAKOTA SI 05

STICK:

Decoro su rete | Mesh-backed decoration | Dekor auf netz | Décor sur filet | Decoración en red | Декор в сету | 网板背帖装饰件

 **Pezzi per scatola**
Pieces for box

Stick 2



FLOOR and WALL: Havana SI 04 200x1200 / 8"x48" NAT RECT

CARATTERISTICHE TECNICHE

Technical specifications | Technische Eigenschaften | Caractéristiques techniques | Características técnicas | Технические характеристики | 技术特征

STANDARD EN 14411 - G

	CARATTERISTICHE TECNICHE TECHNICAL DATA TECHNISCHE DATEN CARACTERISTIQUES TECHNIQUES CARACTERÍSTICAS TÉCNICAS ТЕХНИЧЕСКИЕ ХАРАКТЕРИСТИКИ 技术特征	NORMA STANDARD NORM NORME NORMA ЗНАЧЕНИЯ 标准	VALORI PRESCRITTI DALLE NORME EN 14411 - G INTERNATIONAL STANDARDS EN 14411 - G INTERNATIONALE NORMWERTE EN 14411 - G VALEURS PREVUES PAR LES NORMES EN 14411 - G VALORES PREVISTOS POR LAS NORMAS EN 14411 - G ПРЕДУСМОТРЕННЫЕ СТАНДАРТНОМ EN 14411-G EN 14411 - G标准规定值	*VALORE MEDIO MIRAGE MIRAGE AVERAGE VALUE MIRAGE MITTELWERT VALEURS MOYEN MIRAGE VALOR MEDIO MIRAGE СРЕДНЕЕ ЗНАЧЕНИЕ MIRAGE MIRAGE平均值
	CARATTERISTICHE DIMENSIONALI - SIZE CHARACTERISTICS - MASSEIGENSCHAFTEN DETERMINATION DES CARACTERISTIQUES DIMENSIONNELLES - CARACTERÍSTICAS DIMENSIONALES - РАЗМЕРНЫЕ ХАРАКТЕРИСТИКИ - 尺寸特征			NAT
	LATI SIDES - SEITEN COTES - CANTOS РАЗМЕРЫ СТОРОН - 侧边	EN ISO 10545-2	± 0,3% MAX (± 1,0 mm MAX)	CONFORME COMPLYING
	SPESSORE THICKNESS - DICKE EPAISSEUR - ESPESOR ТОЛЩИНА - 厚度	EN ISO 10545-2	± 5,0% MAX (± 0,5 mm MAX)	CONFORME COMPLYING
	RETTILINEITÀ DEGLI SPIGOLI STRAIGHTNESS OF SIDES - GERADLINIGKEIT DER KANTEN RECTITUDE DES ARETES - RECTITUD DE LOS CANTOS КОСОУГОЛЬНОСТЬ - 边角平直度	EN ISO 10545-2	± 0,3% MAX (± 0,8 mm MAX)	CONFORME COMPLYING
	ORTOGONALITÀ RECTANGULARITY - RECHTWINKLIGKEIT PERPENDICULARITÉ - ORTOGONALIDAD КРИВИЗНА СТОРОН - 直角度	EN ISO 10545-2	± 0,3% MAX (± 1,5 mm MAX)	CONFORME COMPLYING
	PLANARITÀ SURFACE FLATNESS - EBENFLÄCHIGKEIT PLANEITE DE SURFACE - PLANEIDAD КРИВИЗНА ЛИЦЕВОЙ ПОВЕРХНОСТИ - 平整度	EN ISO 10545-2	± 0,4% MAX (± 1,8 mm MAX)	CONFORME COMPLYING
	ASSORBIMENTO D'ACQUA WATER ABSORPTION - WASSERAUFNAHME ABSORPTION D'EAU - ABSORCIÓN DE AGUA ВОДОПОГЛОЩЕНИЕ - 吸水率	EN ISO 10545-3	≤ 0,5%	≤ 0,1%
	RESISTENZA ALLA FLESSIONE FLEXION RESISTANCE - BIEGEFESTIGKEIT RESISTANCE A LA FLEXION - RESISTENCIA A LA FLEXIÓN ПРЕДЕЛ ПРОЧНОСТИ ПРИ ИЗГИБЕ - 抗弯强度	EN ISO 10545-4	S ≥ 700 N (< 7,5 mm) S ≥ 1.300 N (> 7,5 mm) R ≥ 35 N/mm².	≧ 9 mm: S≥2400N R≥48 N/mm²
	RESISTENZA ALL'URTO IMPACT RESISTANCE - STOSSFESTIGKEIT RESISTANCE AUX CHOCES - RESISTENCIA A LOS GOLPES УДАРОСТОЙКОСТЬ - 抗冲击强度	EN ISO 10545-5	VALORE DICHIARATO DECLARED VALUE	> 0,80
	RESISTENZA ALL'ABRAZIONE ABRASION RESISTANCE - ABRIEFESTIGKEIT RESISTANCE A L'ABRASION - RESISTENCIA A LA ABRASIÓN СТОЙКОСТЬ К ИСТИРАНИЮ - 耐磨强度	EN ISO 10545-6	≤ 175 mm³	< 150 mm³
	COEFFICIENTE DI DILATAZIONE TERMICA LINEARE COEFFICIENT OF LINEAR THERMAL-EXPANSION - LINEARER WÄRMEAUDEHNUNGSKOEFFIZIENT COEFFICIENT DE DILATATION THERMIQUE LINEAIRE - COEFICIENTE DE DILATACIÓN TÉRMICA LINEAL КОЭФФИЦИЕНТ ЛИНЕЙНОГО ТЕРМИЧЕСКОГО РАСШИРЕНИЯ - 线性热膨胀系数	EN ISO 10545-8	-	α=7,3x10 ⁻⁶ °C ⁻¹
	RESISTENZA AGLI SBALZI TERMICI RESISTANCE TO THERMAL SHOCKS - BESTÄNDIGKEIT GEGEN TEMPERATURSCHWANKUNGEN RESISTANCE AUX CHOCES THERMIQUES - RESISTENCIA A LOS CHOQUES TÉRMICOS СТОЙКОСТЬ К ПЕРЕПАДАМ ТЕМПЕРАТУРЫ - 耐热突变性	EN ISO 10545-9	TEST SUPERATO SECONDO EN ISO 10545-1 PASS ACCORDING EN ISO 10545-1	NESSUN DANNO NO DAMAGE
	RESISTENZA AL GELO FROST RESISTANCE - FROSTBESTÄNDIGKEIT RESISTANCE AU GEL - RESISTENCIA AL HIELO МОРОЗОСТОЙКОСТЬ - 耐冻性	EN ISO 10545-12	TEST SUPERATO SECONDO EN ISO 10545-1 PASS ACCORDING EN ISO 10545-1	NESSUN DANNO NO DAMAGE
	RESISTENZA ALL'ATTACCO CHIMICO RESISTANCE TO CHEMICALS - CHEMIKALIENBESTÄNDIGKEIT RESISTANCE A L'ATTAQUE CHIMIQUE - RESISTENCIA QUÍMICA ХИМИЧЕСКАЯ СТОЙКОСТЬ - 耐化学作用	EN ISO 10545-13	B MIN.	A LA HA
	RESISTENZA ALLE MACCHIE RESISTANCE TO STAINS - FLECKENBESTÄNDIGKEIT RESISTANCE AUX TACHES - RESISTENCIA A LAS MANCHAS УСТОЙЧИВОСТЬ К ПЯТНООБРАЗОВАНИЮ - 防污性	EN ISO 10545-14	VALORE DICHIARATO DECLARED VALUE	5
	CESSIONE DI PIOMBO E CADMIO LEAD AND CADMIUM DISCHARGE - ABGABE VON BLEI UND CADMIUM PERTE DE PLOMB ET CADMIUM - CESIÓN DE PLOMO Y CADMIO ВЫДЕЛЕНИЕ СВИНЦА И КАДМИЯ - 铅和镉的排放	EN ISO 10545-15	VALORE DICHIARATO DECLARED VALUE	< AL LIMITE DI RILEVAMENTO < THAN INSTRUMENT LIMIT
				NAT
		DM 236/89 BCRA	> 0,40	> 0,40
		ANSI A326.3	Wet and Dry	≥ 0,42
		AS 4586	-	-
		DIN 51130	-	R9
		DIN 51097	-	-
		UNE 41901	≥ CL1	CL1
		BS 7976 sl.96-4S	Wet and Dry	-
		BS 7976 sl.55-TRL	Wet and Dry	-
	SCIVOLosità SKID RESISTANCE - RUTSCHWERT GLISSANCE - ADHERENCIA СКОЛЬЗКОСТЬ - 防滑性			

Per i certificati specifici, contattare Mirage SpA - For specific certificates, please contact Mirage SpA - Für die speziellen Zertifikate wenden Sie sich bitte an Mirage SpA - Pour les certificats spécifiques, veuillez contacter Mirage SpA
Para los certificados específicos, contactar Mirage SpA - Для сертификатов обращайтесь в компанию Mirage SpA - 关于具体的证书, 请联系Mirage SpA公司



INDOOR FLOOR: Orsi **SK 06** 300x600 / 12"x24" NAT RECT
OUTDOOR FLOOR: Orsi **SK 06** 600x600 / 24"x24" ST RECT EVO_2/E" 20 mm

SILVERLAKE

A new take on quartzite stones, in porcelain stoneware: elegant nuances, painstaking details and soft veining effects able to faithfully reproduce the variable colours of the natural material.

Silverlake has been developed with a colour range able to respond to a variety of needs on the market, for both residential use and design projects: a range of balanced, neutral colours, for maximum versatility.

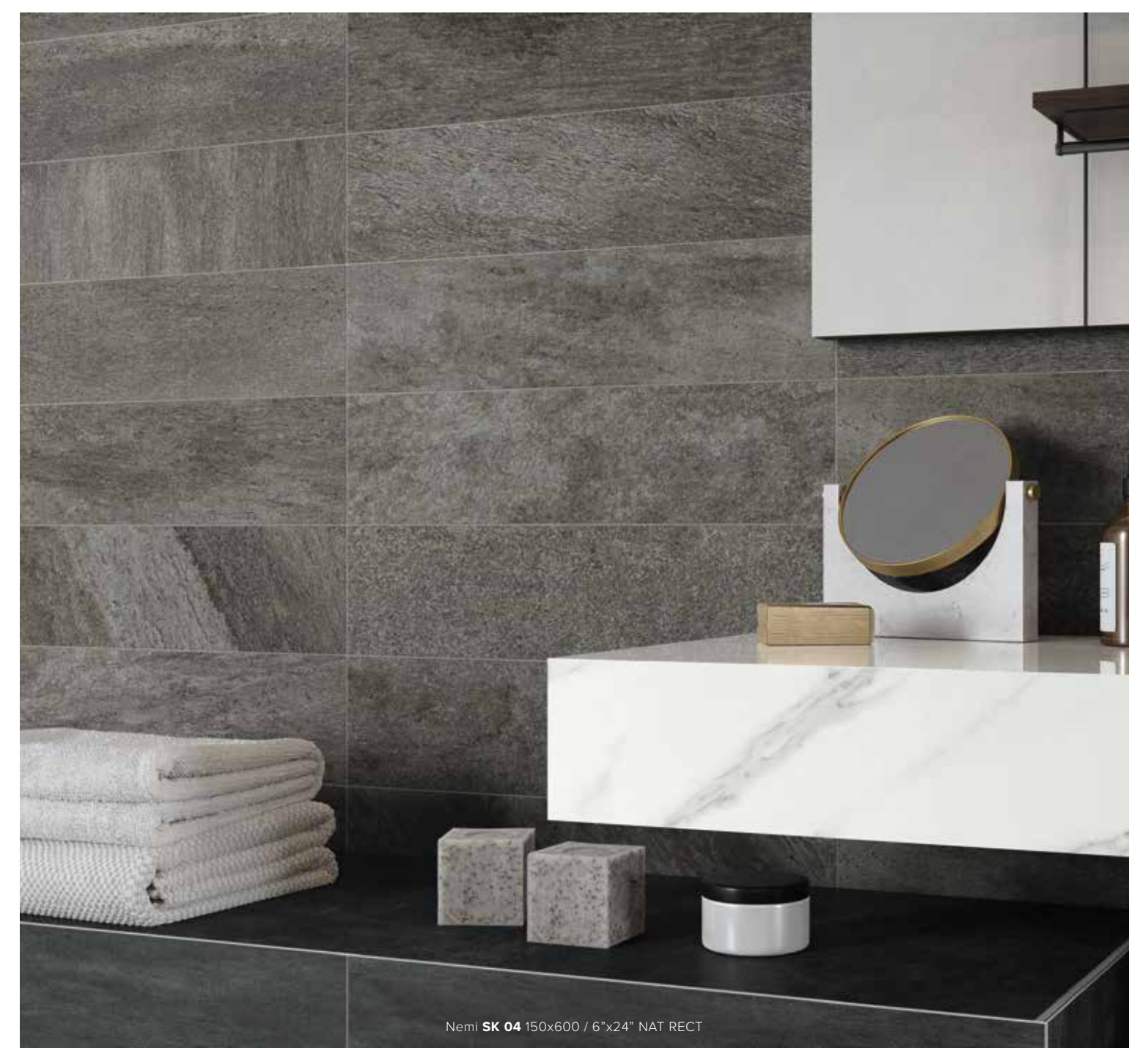

Nemi **SK 04** 150x600 / 6"x24" NAT RECT

COLORI

Colours | Farben | Couleurs | Colores | Цветов | 种颜色

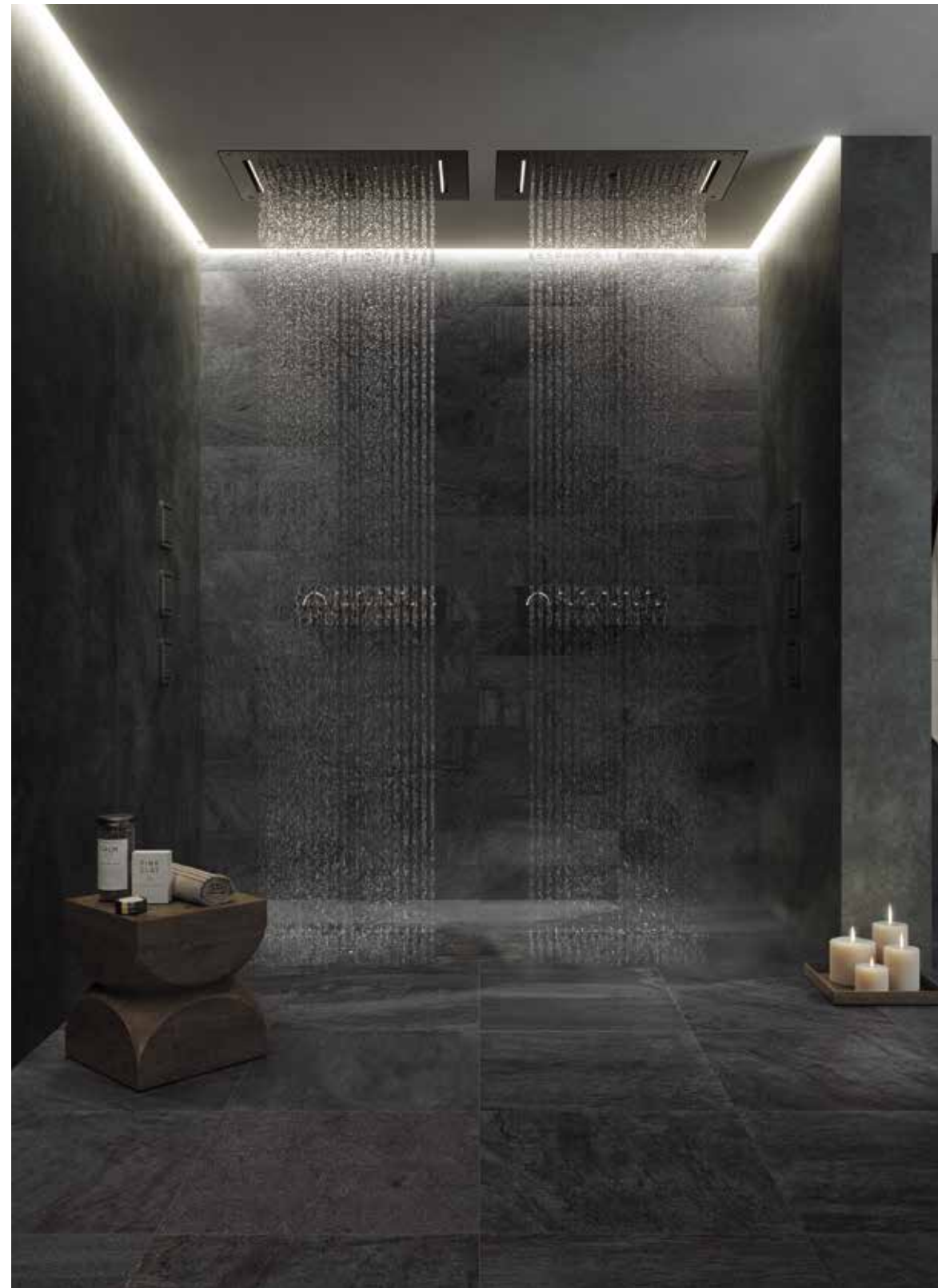

WALL: Moro **SK 05** 150x600 / 6"x24" NAT RECT
FLOOR: Moro **SK 05** 600x600 / 24"x24" NAT RECT



Braies
SK 01



Resia
SK 02



Moritz
SK 03



Nemi
SK 04



Moro
SK 05



Orsi
SK 06



INDOOR FLOOR: Braies **SK 01** 600x1200 / 24"x48" NAT RECT
OUTDOOR FLOOR: Braies **SK 01** 600x600 / 24"x24" ST RECT EVO_2/E" 20 mm + Swimming pools special pieces



COLORI

Colours | Farben | Couleurs | Colores | Цветов | 种颜色

BRAIES SK 01



Formati Nominali Nominal Sizes	Superficie Finish	Spessore mm Thickness mm
300x300 / 12"x12"	NAT RECT	9
150x600 / 6"x24"	NAT RECT	9
300x600 / 12"x24"	NAT / ST RECT	9
600x600 / 24"x24"	NAT / ST RECT	9
600x1200 / 24"x48"	NAT / ST RECT	9
600x600 / 24"x24"	ST RECT	20
600x1200 / 24"x48"	ST RECT	20

Stucchi consigliati Recommended grouts		
KERAKOLL	43	
MAPEI	111 Grigio Argento	
LATICRETE	88 Silver Shadow	

NEMI SK 04



Formati Nominali Nominal Sizes	Superficie Finish	Spessore mm Thickness mm
300x300 / 12"x12"	NAT RECT	9
150x600 / 6"x24"	NAT RECT	9
300x600 / 12"x24"	NAT / ST RECT	9
600x600 / 24"x24"	NAT / ST RECT	9
600x1200 / 24"x48"	NAT / ST RECT	9
600x600 / 24"x24"	ST RECT	20
600x1200 / 24"x48"	ST RECT	20

Stucchi consigliati Recommended grouts		
KERAKOLL	08	
MAPEI	114 Antracite	
LATICRETE	45 Raven	

RESIA SK 02



Formati Nominali Nominal Sizes	Superficie Finish	Spessore mm Thickness mm
300x300 / 12"x12"	NAT RECT	9
150x600 / 6"x24"	NAT RECT	9
300x600 / 12"x24"	NAT / ST RECT	9
600x600 / 24"x24"	NAT / ST RECT	9
600x1200 / 24"x48"	NAT / ST RECT	9
600x600 / 24"x24"	ST RECT	20
600x1200 / 24"x48"	ST RECT	20

Stucchi consigliati Recommended grouts		
KERAKOLL	44	
MAPEI	110 Manhattan	
LATICRETE	89 Smoke Grey	

MORO SK 05



Formati Nominali Nominal Sizes	Superficie Finish	Spessore mm Thickness mm
300x300 / 12"x12"	NAT RECT	9
150x600 / 6"x24"	NAT RECT	9
300x600 / 12"x24"	NAT / ST RECT	9
600x600 / 24"x24"	NAT / ST RECT	9
600x1200 / 24"x48"	NAT / ST RECT	9
600x600 / 24"x24"	ST RECT	20
600x1200 / 24"x48"	ST RECT	20

Stucchi consigliati Recommended grouts		
KERAKOLL	11	
MAPEI	114 Antracite	
LATICRETE	45 Raven	

MORITZ SK 03



Formati Nominali Nominal Sizes	Superficie Finish	Spessore mm Thickness mm
300x300 / 12"x12"	NAT RECT	9
150x600 / 6"x24"	NAT RECT	9
300x600 / 12"x24"	NAT / ST RECT	9
600x600 / 24"x24"	NAT / ST RECT	9
600x1200 / 24"x48"	NAT / ST RECT	9
600x600 / 24"x24"	ST RECT	20
600x1200 / 24"x48"	ST RECT	20

Stucchi consigliati Recommended grouts		
KERAKOLL	06	
MAPEI	112 Grigio Medio	
LATICRETE	78 Sterling Silver	

ORSI SK 06



Formati Nominali Nominal Sizes	Superficie Finish	Spessore mm Thickness mm
300x300 / 12"x12"	NAT RECT	9
150x600 / 6"x24"	NAT RECT	9
300x600 / 12"x24"	NAT / ST RECT	9
600x600 / 24"x24"	NAT / ST RECT	9
600x1200 / 24"x48"	NAT / ST RECT	9
600x600 / 24"x24"	ST RECT	20
600x1200 / 24"x48"	ST RECT	20

Stucchi consigliati Recommended grouts		
KERAKOLL	06	
MAPEI	112 Grigio Medio	
LATICRETE	78 Sterling Silver	

RIASSUNTIVO FORMATI ED IMBALLI

Summary of sizes and packaging | Übersicht über Formate und Verpackungen | Récapitulatif formats et emballages
Sinóptico de formatos y embalajes | Краткая информация о форматах и упаковках | 规格和包装概述

		9 mm							
Formati Nominali Nominal Sizes		300x300 12"x12"	150x600 6"x24"	300x600 12"x24"	600x600 24"x24"	600x1200 24"x48"			
Tutti i formati sono rettificati. All sizes are rectified.									
Superficie Finish		NAT	NAT	NAT	ST	NAT	ST	NAT	ST
BRAIES SK 01	V3	■	■	■	■	■	■	■	■
RESIA SK 02	V3	■	■	■	■	■	■	■	■
MORITZ SK 03	V3	■	■	■	■	■	■	■	■
NEMI SK 04	V3	■	■	■	■	■	■	■	■
MORO SK 05	V3	■	■	■	■	■	■	■	■
ORSI SK 06	V4	■	■	■	■	■	■	■	■
Peso lordo per scatola Gross weight per box		22,50	26,92	26,18	26,18	23,07	23,07	30,00	30,00
Pezzi per scatola Pieces for box		12	14	7	7	3	3	2	2
mq. scatola sqm. box		1,08	1,26	1,26	1,26	1,08	1,08	1,44	1,44
Scatole / Full pallet boxes / Full pallet		48	40	40	40	40	40	35	35
mq. pallet sqm. pallet		51,84	50,40	50,40	50,40	43,20	43,20	50,40	50,40

TUTTI I FORMATI IN 9 MM NAT SONO REALIZZATI CON LA TECNOLOGIA PERFORMA (NAT R10 A+B).
All 9 mm NAT sizes are produced with PERFORMA technology (NAT R10 A+B).

		20 mm	
Formati Nominali Nominal Sizes		600x600 24"x24"	600x1200 24"x48"
Tutti i formati sono rettificati. All sizes are rectified.			
Superficie Finish		ST	ST
BRAIES SK 01	V3	■	■
RESIA SK 02	V3	■	■
MORITZ SK 03	V3	■	■
NEMI SK 04	V3	■	■
MORO SK 05	V3	■	■
ORSI SK 06	V4	■	■
Peso lordo per scatola Gross weight per box		30,60	32,00
Pezzi per scatola Pieces for box		2	1
mq. scatola sqm. box		0,72	0,72
Scatole / Full pallet boxes / Full pallet		30	35
mq. pallet sqm. pallet		21,60	25,20

NAT: Naturale | Natural | Natur/unpoliert | Naturelle | Natural | Натуральный | 天然
ST: Strutturato | Structured | Strukturiert | Structuré | Estructurado | Труктурированный | 结构

PEZZI SPECIALI

Special pieces | Sonderstücke | Pièces spéciales | Piezas especiales | специальные изделия | 特殊件

	Battiscopa*	Gradino A*	Gradino G*	Gradino B ang.	Gradino B		
Pezzi speciali Special pieces	72x600 27/8"x24"	300x600 12"x24"	330x1200 13/5"x48"	300x600 12"x24"	330x330 13/5"x13/5"	330x600 13/5"x24"	330x1200 13/5"x48"
Superficie Finish	NAT	NAT	NAT	NAT	NAT	NAT	NAT
BRAIES SK 01	■	■	■	■	■	■	■
RESIA SK 02	■	■	■	■	■	■	■
MORITZ SK 03	■	■	■	■	■	■	■
NEMI SK 04	■	■	■	■	■	■	■
MORO SK 05	■	■	■	■	■	■	■
ORSI SK 06	■	■	■	■	■	■	■
Pezzi per scatola Pieces for box	10	7	4	7	4	4	2

* Finitura a becco di civetta | One-round edge shaping | Ausführung mit Eckabrundung | Façonnage à bord rond | Acabado canto romo | Плитка с завалом | 鷹嘴边缘处理

DECORI

Decors | Dekore | Decors | Decoros | Декоры | 装饰砖

Layer NAT
300x600 / 12"x24"

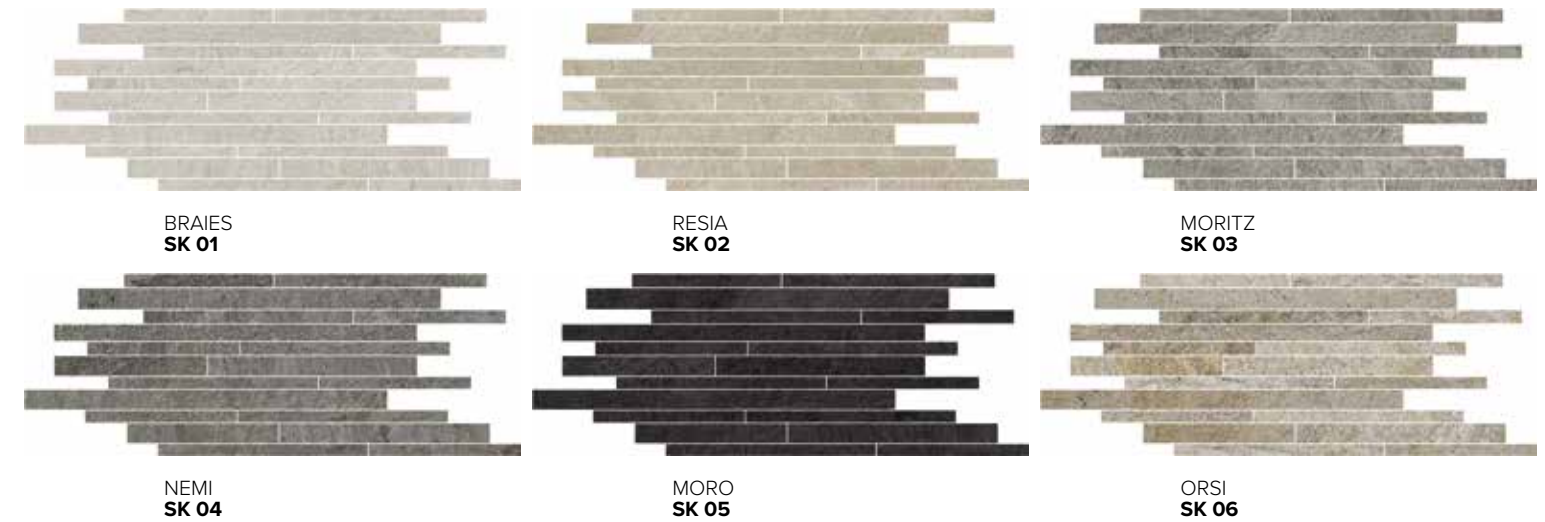

MY NOTES

.....

.....

.....

.....

Maggiori informazioni
More information



DECORI

Decors | Dekore | Decors | Decoros | Декоры | 装饰砖

Mosaico 36T NAT
300x300 / 12"x12"
Tessere 48x48 / 2"x2"

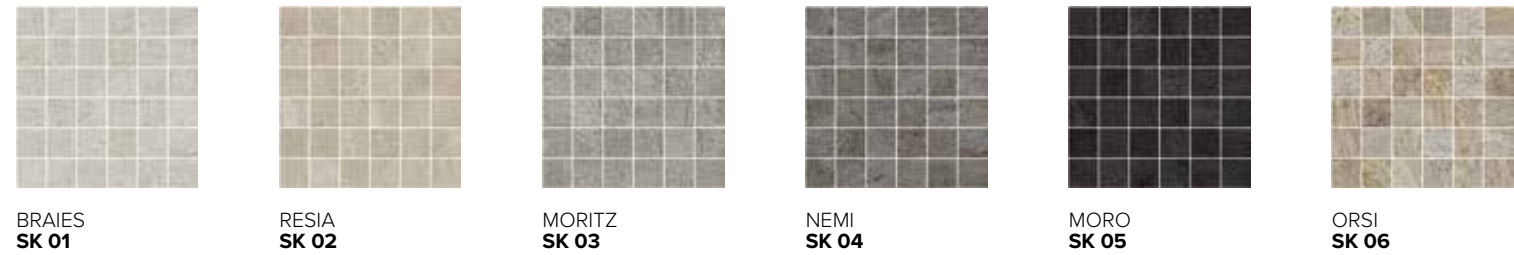

Rudd NAT (burattato)
300x300 / 12"x12"
Tessere 60x60 / 2 2/5"x2 2/5"

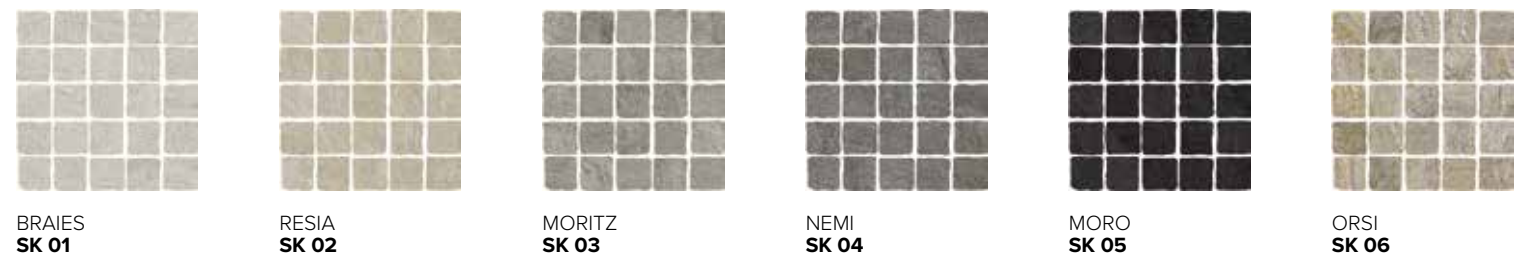

Knit NAT
300x300 / 12"x12"
Tessere 24x48 / 1"x2"

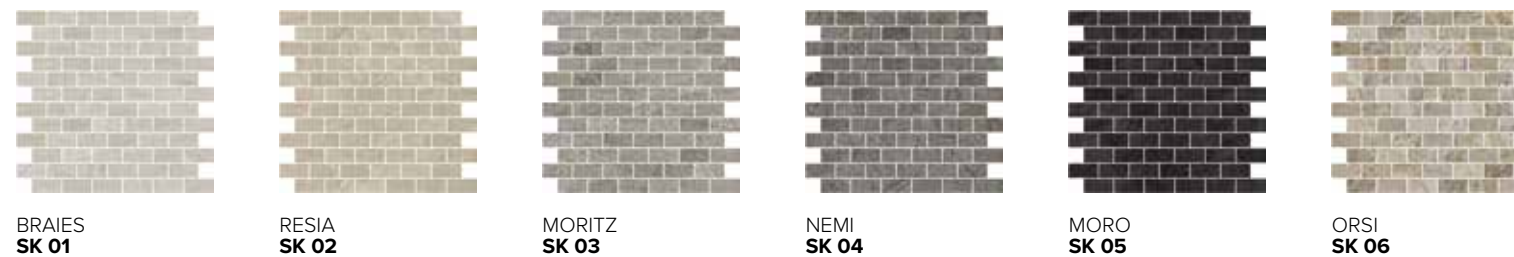

	Pezzi per scatola Pieces for box
Mosaico 36T	6
Rudd	11
Knit	6
Layer	4

MOSAICO 36T, RUDD, KNIT, LAYER:
Decoro su rete | Mesh-backed decoration | Dekor auf netz | Décor sur filet | Decoración en red | Декор в сети | 网板背帖装饰件

NAT: Naturale | Natural | Natur/unpoliert | Naturelle | Natural | Натуральный | 天然

CARATTERISTICHE TECNICHE

Technical specifications | Technische Eigenschaften | Caractéristiques techniques | Características técnicas | Технические характеристики | 技术特征

STANDARD EN 14411 - G

	CARATTERISTICHE TECNICHE TECHNICAL DATA TECHNISCHE DATEN CARACTERISTIQUES TECHNIQUES CARACTERÍSTICAS TÉCNICAS ТЕХНИЧЕСКИЕ ХАРАКТЕРИСТИКИ 技术特征	NORMA STANDARD NORM NORME NORMA НОРМА 標準	VALORI PRESCRITTI DALLE NORME EN 14411 - G INTERNATIONAL STANDARDS EN 14411 - G INTERNATIONALE NORMWERTE EN 14411 - G VALEURS PREVUES PAR LES NORMES EN 14411 - G VALORES PREVISTOS POR LAS NORMAS EN 14411 - G ПРЕДУСМОТРЕННЫЕ СТАНДАРТОМ EN 14411-G EN 14411 - G标准规定值	*VALORE MEDIO MIRAGE MIRAGE AVERAGE VALUE MIRAGE MITTELWERT VALEURS MOYEN MIRAGE VALOR MEDIO MIRAGE СРЕДНЕЕ ЗНАЧЕНИЕ MIRAGE MIRAGE平均值
	LATI SIDES - SEITEN COTES - CANTOS РАЗМЕРЫ СТОРОН - 側邊	EN ISO 10545-2	± 0,3% MAX (± 1,0 mm MAX)	CONFORME COMPLYING
	SPESSORE THICKNESS - DICKE EPAISSEUR - ESPESOR ТОЛЩИНА - 厚度	EN ISO 10545-2	± 5,0% MAX (± 0,5 mm MAX)	CONFORME COMPLYING
	RETTILINEITÀ DEGLI SPIGOLI STRAIGHTNESS OF SIDES - GERADLINIGKEIT DER KANTEN RECTITUDE DES ARETES - RECTITUD DE LOS CANTOS КОСОУГОЛЬНОСТЬ - 边角平直度	EN ISO 10545-2	± 0,3% MAX (± 0,8 mm MAX)	CONFORME COMPLYING
	ORTOGONALITÀ RECTANGULARITY - RECHTWINKLIGKEIT PERPENDICULARITÉ - ORTOGONALIDAD КРИВИЗНА СТОРОН - 直角度	EN ISO 10545-2	± 0,3% MAX (± 1,5 mm MAX)	CONFORME COMPLYING
	PLANARITÀ SURFACE FLATNESS - EBENFLÄCHIGKEIT PLANEITE DE SURFACE - PLANEIDAD КРИВИЗНА ЛИЦЕВОЙ ПОВЕРХНОСТИ - 平整度	EN ISO 10545-2	± 0,4% MAX (± 1,8 mm MAX)	CONFORME COMPLYING
	ASSORBIMENTO D'ACQUA WATER ABSORPTION - WASSERAUFNAHME ABSORPTION D'EAU - ABSORCIÓN DE AGUA ВОДОПОГЛОЩЕНИЕ - 吸水率	EN ISO 10545-3	≤ 0,5%	≤ 0,1%
	RESISTENZA ALLA FLESSIONE FLEXION RESISTANCE - BIEGEFESTIGKEIT RESISTANCE A LA FLEXION - RESISTENCIA A LA FLEXIÓN ПРЕДЕЛ ПРОЧНОСТИ ПРИ ИЗГИБЕ - 抗弯强度	EN ISO 10545-4	S ≥ 700 N (< 7,5 mm) S ≥ 1.300 N (> 7,5 mm) R ≥ 35 N/mm².	±9 mm: S≥2.400N R≥48N/mm² ±20 mm: S≥12.500N R≥48N/mm²
	RESISTENZA ALL'URTO IMPACT RESISTANCE - STOSSFESTIGKEIT RESISTANCE AUX CHOCES - RESISTENCIA A LOS GOLPES УДАРСТОЙКОСТЬ - 抗冲击强度	EN ISO 10545-5	VALORE DICHIARATO DECLARED VALUE	> 0,80
	RESISTENZA ALL'ABRASIONE ABRASION RESISTANCE - ABRIEFESTIGKEIT RESISTANCE A L'ABRASION - RESISTENCIA A LA ABRASIÓN СТОЙКОСТЬ К ИСТИРАНИЮ - 耐磨强度	EN ISO 10545-6	≤ 175 mm³	< 150 mm³
	COEFFICIENTE DI DILATAZIONE TERMICA LINEARE COEFFICIENT OF LINEAR THERMAL-EXPANSION - LINEARER WÄRMEAUSSDEHNUNGSKOEFFIZIENT COEFFICIENT DE DILATATION THERMIQUE LINEAIRE - COEFICIENTE DE DILATACIÓN TÉRMICA LINEAL КОЭФФИЦИЕНТ ЛИНЕЙНОГО ТЕРМИЧЕСКОГО РАСТЯЖЕНИЯ - 线性热膨胀系数	EN ISO 10545-8	-	α=6,6x10 ⁻⁶ °C ⁻¹
	RESISTENZA AGLI SBALZI TERMICI RESISTANCE TO THERMAL SHOCKS - BESTÄNDIGKEIT GEGEN TEMPERATURSCHWANKUNGEN RESISTANCE AUX CHOCES THERMIQUES - RESISTENCIA A LOS CHOQUES TÉRMICOS СТОЙКОСТЬ К ПЕРЕПАДАМ ТЕМПЕРАТУРЫ - 耐热突变性	EN ISO 10545-9	TEST SUPERATO SECONDO EN ISO 10545-1 PASS ACCORDING EN ISO 10545-1	NESSUN DANNO NO DAMAGE
	RESISTENZA AL GELO FROST RESISTANCE - FROSTBESTÄNDIGKEIT RESISTANCE AU GEL - RESISTENCIA AL HIELO МОРОЗОСТОЙКОСТЬ - 耐冻性	EN ISO 10545-12	TEST SUPERATO SECONDO EN ISO 10545-1 PASS ACCORDING EN ISO 10545-1	NESSUN DANNO NO DAMAGE
	RESISTENZA ALL'ATTACCO CHIMICO RESISTANCE TO CHEMICALS - CHEMIKALIENBESTÄNDIGKEIT RESISTANCE A L'ATTAQUE CHIMIQUE - RESISTENCIA QUÍMICA ХИМИЧЕСКАЯ СТОЙКОСТЬ - 耐化学品作用	EN ISO 10545-13	B MIN.	A LA HA
	RESISTENZA ALLE MACCHIE RESISTANCE TO STAINS - FLECKENBESTÄNDIGKEIT RESISTANCE AUX TACHES - RESISTENCIA A LAS MANCHAS УСТОЙЧИВОСТЬ К ПЯТНООБРАЗОВАНИЮ - 防污性	EN ISO 10545-14	VALORE DICHIARATO DECLARED VALUE	5
	CESSIONE DI PIOMBO E CADMIO LEAD AND CADMIUM DISCHARGE - ABGABE VON BLEI UND CADMIUM PERTE DE PLOMB ET CADMIUM - CESIÓN DE PLOMO Y CADMIO ВЫДЕЛЕНИЕ СВИНЦА И КАДМИЯ - 铅和镉的排放	EN ISO 10545-15	VALORE DICHIARATO DECLARED VALUE	< AL LIMITE DI RILEVAMENTO < THAN INSTRUMENT LIMIT
	SCIVOLosità SKID RESISTANCE - RUTSCHWERT GLISSANCE - ADHERENCIA СКОЛЬЗКОСТЬ - 防滑性			NAT ST ST 20 mm
	DM 236/89 BCRA	> 0,40	> 0,40 > 0,40 > 0,40	
	ANSI A326.3	Wet and Dry	≥ 0,42 ≥ 0,55 ≥ 0,55	
	AS 4586	-	P3 P4 P4	
	DIN 51130	-	R10 R11 R11	
	DIN 51097	-	A+B A+B+C A+B+C	
	UNE 41901	≥ CL1	CL2 CL3 CL3	
	BS 7976 sl.96-4S	Wet and Dry	≥ 0,36 ≥ 0,36 ≥ 0,36	
	BS 7976 sl.55-TRL	Wet and Dry	≥ 0,36 ≥ 0,36 ≥ 0,36	

Per i certificati specifici, contattare Mirage SpA - For specific certificates, please contact Mirage SpA - Für die speziellen Zertifikate wenden Sie sich bitte an Mirage SpA - Pour les certificats spécifiques, veuillez contacter Mirage SpA - Para los certificados específicos, contactar Mirage SpA - Для сертификатов обращайтесь в компанию Mirage SpA - 关于具体的证书, 请联系Mirage SpA公司



WALL: Perla **VV 02** 1200x2780 / 48"x110" SP RECT
FLOOR: Cortecchia **VV 08** 800x800 / 31½"x31½" SP RECT

VICEVERSA

A neutral aesthetics, a creative passepartout that makes the collection a versatile and eclectic design tool for both architectural and interior design projects.

VICEVERSA is an interpretation of poured concrete enriched by graphics that faithfully reproduce the characteristic flakes and clasts found in the classic sand and mortar mixtures, applied manually by expert craftsmen.



WALL: Alba **VV 07** 1200x2780 / 48"x110" SP RECT
FLOOR: Alba **VV 07** 1200x1200 / 48"x48" SP RECT
TABLE TOP: NORR Hav **RR 06** NAT



WALL: Cocco **VV 01** 1200x2780 / 48"x110" SP RECT
FLOOR: Cocco **VV 01** 1200x1200 / 48"x48" SP RECT

COLORI

Colours | Farben | Couleurs | Colores | Цветов | 种颜色

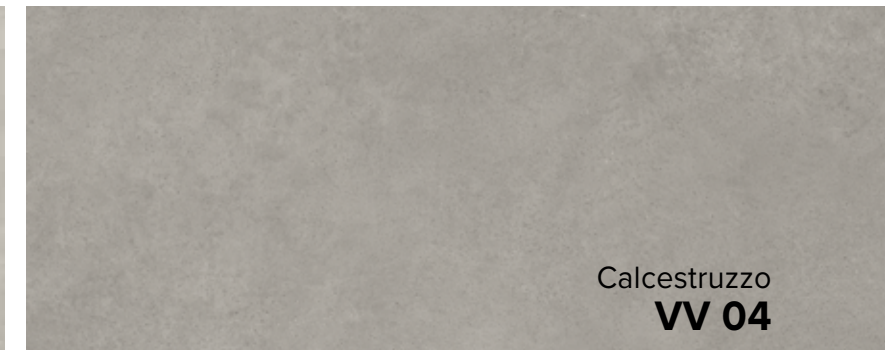



WALL: OUDH Jinkoh **OU 03** 1200x2780 / 48"x110" SP RECT
FLOOR: Vaio **VV 05** 1200x1200 / 48"x48" SP RECT



WALL: Nube **VV 03** Lace 1200x2780 / 48"x110" SP RECT
FLOOR: OUDH Laos **OU 05** 250x1500 / 10"x60" SP RECT

COLORI

Colours | Farben | Couleurs | Colores | Цветов | 种颜色

COCCO VV 01



Formati Nominali Nominal Sizes		Superficie Finish	Spessore mm Thickness mm
300x600 / 12"x24"		NAT RECT	9
600x600 / 24"x24"		NAT / ST RECT	9
600x1200 / 24"x48"		NAT / SP RECT	9
800x800 / 31½"x31½"		SP RECT	9
1200x1200 / 48"x48"		SP RECT	9
1200x2780 / 48"x110"		SP RECT	6

Stucchi consigliati Recommended grouts		
KERAKOLL	05	
MAPEI	111 Grigio Argento	
LATICRETE	88 Silver Shadow	



CALCESTRUZZO VV 04



Formati Nominali Nominal Sizes		Superficie Finish	Spessore mm Thickness mm
300x600 / 12"x24"		NAT RECT	9
600x600 / 24"x24"		NAT / ST RECT	9
600x1200 / 24"x48"		NAT / SP RECT	9
800x800 / 31½"x31½"		SP RECT	9
1200x1200 / 48"x48"		SP RECT	9
1200x2780 / 48"x110"		SP RECT	6

Stucchi consigliati Recommended grouts		
KERAKOLL	08	
MAPEI	113 Grigio Cemento	
LATICRETE	78 Sterling Silver	



PERLA VV 02



Formati Nominali Nominal Sizes		Superficie Finish	Spessore mm Thickness mm
300x600 / 12"x24"		NAT RECT	9
600x600 / 24"x24"		NAT / ST RECT	9
600x1200 / 24"x48"		NAT / SP RECT	9
800x800 / 31½"x31½"		SP RECT	9
1200x1200 / 48"x48"		SP RECT	9
1200x2780 / 48"x110"		SP RECT	6

Stucchi consigliati Recommended grouts		
KERAKOLL	07	
MAPEI	110 Manhattan 2000	
LATICRETE	89 Smoke Grey	



VAIO VV 05



Formati Nominali Nominal Sizes		Superficie Finish	Spessore mm Thickness mm
300x600 / 12"x24"		NAT RECT	9
600x600 / 24"x24"		NAT / ST RECT	9
600x1200 / 24"x48"		NAT / SP RECT	9
800x800 / 31½"x31½"		SP RECT	9
1200x1200 / 48"x48"		SP RECT	9
1200x2780 / 48"x110"		SP RECT	6

Stucchi consigliati Recommended grouts		
KERAKOLL	11	
MAPEI	114 Antracite	
LATICRETE	45 Raven	



NUBE VV 03



Formati Nominali Nominal Sizes		Superficie Finish	Spessore mm Thickness mm
300x600 / 12"x24"		NAT RECT	9
600x600 / 24"x24"		NAT / ST RECT	9
600x1200 / 24"x48"		NAT / SP RECT	9
800x800 / 31½"x31½"		SP RECT	9
1200x1200 / 48"x48"		SP RECT	9
1200x2780 / 48"x110"		SP RECT	6
Lace 1200x2780 / 48"x110"		SP RECT	6

Stucchi consigliati Recommended grouts		
KERAKOLL	06	
MAPEI	112 Grigio Medio	
LATICRETE	78 Sterling Silver	



LINO VV 06



Formati Nominali Nominal Sizes		Superficie Finish	Spessore mm Thickness mm
300x600 / 12"x24"		NAT RECT	9
600x600 / 24"x24"		NAT / ST RECT	9
600x1200 / 24"x48"		NAT / SP RECT	9
800x800 / 31½"x31½"		SP RECT	9
1200x1200 / 48"x48"		SP RECT	9
1200x2780 / 48"x110"		SP RECT	6

Stucchi consigliati Recommended grouts		
KERAKOLL	07	
MAPEI	110 Manhattan 2000	
LATICRETE	90 Light Pewter	



COLORI

Colours | Farben | Couleurs | Colores | Цветов | 种颜色

ALBA **VV 07**



Formati Nominali Nominal Sizes	Superficie Finish	Spessore mm Thickness mm
300x600 / 12"x24"	NAT RECT	9
600x600 / 24"x24"	NAT / ST RECT	9
600x1200 / 24"x48"	NAT / SP RECT	9
800x800 / 31½"x31½"	SP RECT	9
1200x1200 / 48"x48"	SP RECT	9
1200x2780 / 48"x110"	SP RECT	6
Lace 1200x2780 / 48"x110"	SP RECT	6

Stucchi consigliati Recommended grouts		
KERAKOLL	06	
MAPEI	112 Grigio Medio	
LATICRETE	78 Sterling Silver	



CORTECCIA **VV 08**



Formati Nominali Nominal Sizes	Superficie Finish	Spessore mm Thickness mm
300x600 / 12"x24"	NAT RECT	9
600x600 / 24"x24"	NAT / ST RECT	9
600x1200 / 24"x48"	NAT / SP RECT	9
800x800 / 31½"x31½"	SP RECT	9
1200x1200 / 48"x48"	SP RECT	9
1200x2780 / 48"x110"	SP RECT	6

Stucchi consigliati Recommended grouts		
KERAKOLL	08	
MAPEI	113 Grigio Cemento	
LATICRETE	24 Natural Grey	



WALL: Calcestruzzo **VV 04** 1200x2780 / 48"x110" SP RECT
 FLOOR: Veneziano 800x800 / 31½"x31½" SP RECT

RIASSUNTIVO FORMATI ED IMBALLI

Summary of sizes and packaging | Übersicht über Formate und Verpackungen | Récapitulatif formats et emballages
Sinóptico de formatos y embalajes | Краткая информация о форматах и упаковках | 规格和包装概述

		± 9 mm					
Formati Nominali Nominal Sizes		300x600 12"x24"	600x600 24"x24"	600x1200 24"x48"	800x800 31½"x31½"	1200x1200 48"x48"	
Tutti i formati sono rettificati. All sizes are rectified.							
Superficie Finish		NAT	NAT	ST	NAT	SP	SP
COCCO VV 01	V2	■	■	■	■	■	■
PERLA VV 02	V2	■	■	■	■	■	■
NUBE VV 03	V2	■	■	■	■	■	■
CALCESTRUZZO VV 04	V2	■	■	■	■	■	■
VAIO VV 05	V2	■	■	■	■	■	■
LINO VV 06	V2	■	■	■	■	■	■
ALBA VV 07	V2	■	■	■	■	■	■
CORTECCIA VV 08	V2	■	■	■	■	■	■
Peso lordo per scatola Gross weight per box		25,58	22,12	22,12	30,00	30,00	27,36
Pezzi per scatola Pieces for box		7	3	3	2	2	2
mq. scatola sqm. box		1,26	1,08	1,08	1,44	1,44	1,28
Scatole / Full pallet boxes / Full pallet		40	40	40	35	35	48
mq. pallet sqm. pallet		50,40	43,20	43,20	50,40	50,40	61,44

TUTTI I FORMATI IN 9 MM NAT SONO REALIZZATI CON LA TECNOLOGIA PERFORMA.
All 9 mm NAT sizes are produced with PERFORMA technology.

		± 6 mm	
Formati Nominali Nominal Sizes		1200x2780 48"x110"	Lace 1200x2780 48"x110"
Tutti i formati sono rettificati. All sizes are rectified.			
Superficie Finish		SP	SP
COCCO VV 01	V2	■	-
PERLA VV 02	V2	■	-
NUBE VV 03	V2	■	■
CALCESTRUZZO VV 04	V2	■	-
VAIO VV 05	V2	■	-
LINO VV 06	V2	■	-
ALBA VV 07	V2	■	■
CORTECCIA VV 08	V2	■	-
Peso lordo per scatola Gross weight per box			
Pezzi per scatola Pieces for box			
mq. scatola sqm. box		Please refer to page 588	Please refer to page 588
Scatole / Full pallet boxes / Full pallet			
mq. pallet sqm. pallet			

Per tutti i grandi formati è possibile prevedere, su richiesta, e con un lotto minimo l'applicazione di una stuoia in fibra di vetro.
For big sizes, a fibreglass mat can be applied on request, with a minimum production batch.

ACCORDIMENTI SPECIFICI PER L'APPLICAZIONE DELLE GRANDI LASTRE IN 6 MM DI SPESSORE: p. 582 | Precautions for 6mm big slabs applications: page 582 | spezifische Anweisungen zur Nutzung der Grossformate in 6mm: seite 582 | Precauciones específicas para la aplicación de las grandes placas en 6 mm de espesor: page 582 | Precautions spécifiques pour la pose des grandes plaques en 6mm d'épaisseur: página 582 | специальные предосторожности для укладки больших плит толщиной 6 мм : страница 582

PEZZI SPECIALI

Special pieces | Sonderstücke | Pièces spéciales | Piezas especiales | специальные изделия | 特殊件

		± 9 mm					
		Battiscopa*	Battiscopa*	Gradino A*	Gradino A*	Gradino A*	Gradino G*
Pezzi speciali Special pieces		72x600 27½"x24"	72x800 27½"x31½"	300x600 12"x24"	330x800 13½"x31½"	330x1200 13½"x48"	300x600 12"x24"
Superficie Finish		NAT	SP	NAT	SP	NAT	NAT
COCCO VV 01		■	■	■	■	■	■
PERLA VV 02		■	■	■	■	■	■
NUBE VV 03		■	■	■	■	■	■
CALCESTRUZZO VV 04		■	■	■	■	■	■
VAIO VV 05		■	■	■	■	■	■
LINO VV 06		■	■	■	■	■	■
ALBA VV 07		■	■	■	■	■	■
CORTECCIA VV 08		■	■	■	■	■	■
Pezzi per scatola Pieces for box		10	10	7	7	4	7

* **Finitura a becco di civetta** | One-round edge shaping | Ausführung mit Eckabrundung | Façonnage à bord rond | Acabado canto romo | Плитка с завалом | 鹰嘴边缘处理

		± 6 mm					
		Gradino G*	Gradino B ang.	Gradino B ang.	Gradino B	Gradino B	Gradino B
Pezzi speciali Special pieces		330x800 13½"x31½"	330x330 13½"x13½"	330x330 13½"x13½"	330x600 13½"x24"	330x800 13½"x31½"	330x1200 13½"x48"
Superficie Finish		SP	NAT	SP	NAT	SP	NAT
COCCO VV 01		■	■	■	■	■	■
PERLA VV 02		■	■	■	■	■	■
NUBE VV 03		■	■	■	■	■	■
CALCESTRUZZO VV 04		■	■	■	■	■	■
VAIO VV 05		■	■	■	■	■	■
LINO VV 06		■	■	■	■	■	■
ALBA VV 07		■	■	■	■	■	■
CORTECCIA VV 08		■	■	■	■	■	■
Pezzi per scatola Pieces for box		7	4	4	4	4	1

MY NOTES

.....

.....

.....

.....

.....

Maggiori informazioni
More information



NAT: Naturale | Natural | Natur/unpoliert | Naturelle | Natural | Натуральный | 天然
ST: Strutturata | Structured | Strukturiert | Structuré | Estructurado | Труктурированный | 结构
SP: Spazzolata

DECORI

Decors | Dekore | Decors | Decoros | Декоры | 装饰砖

Mosaico 36T NAT
300x300 / 12"x12"
Tessere 48x48 / 2"x2"



COCCO **VV 01**

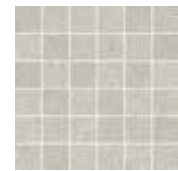

PERLA **VV 02**

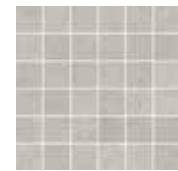

NUBE **VV 03**

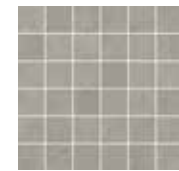

CALCESTRUZZO **VV 04**

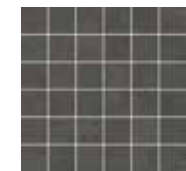

VAIO **VV 05**



LINO **VV 06**



ALBA **VV 07**

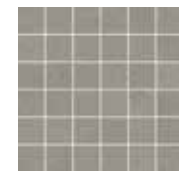

CORTECCIA **VV 08**

Plume SP
300x300 / 12"x12"



COCCO **VV 01**



PERLA **VV 02**



NUBE **VV 03**



CALCESTRUZZO **VV 04**



VAIO **VV 05**



LINO **VV 06**



ALBA **VV 07**



CORTECCIA **VV 08**

Plume Mix SP
300x300 / 12"x12"



PERLA **VV 02**
+ Veneziano



NUBE **VV 03**
+ Veneziano



LINO **VV 06**
+ Veneziano

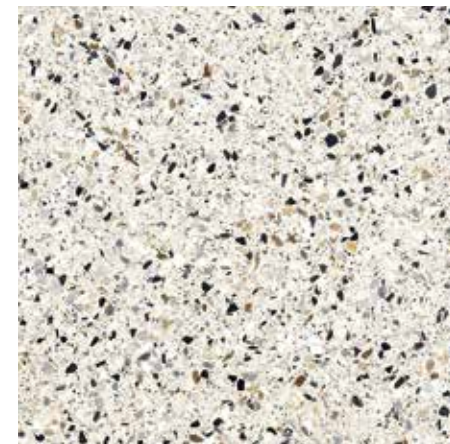

Veneziano SP RECT
800x800 / 31½"x31½"

NAT: Naturale | Natural | Natur/unpoliert | Naturelle | Natural | Натуральный | 天然
SP: Spazzolata

DECORI

Decors | Dekore | Decors | Decoros | Декоры | 装饰砖

Patchy NAT
400x347 / 15¾"x13⅝"



COCCO **VV 01**



PERLA **VV 02**



NUBE **VV 03**



CALCESTRUZZO **VV 04**



VAIO **VV 05**



LINO **VV 06**



ALBA **VV 07**



CORTECCIA **VV 08**

Curtain SP
400x400 / 15¾"x15¾"



COCCO **VV 01**



PERLA **VV 02**



NUBE **VV 03**



CALCESTRUZZO **VV 04**



VAIO **VV 05**



LINO **VV 06**



ALBA **VV 07**



CORTECCIA **VV 08**

Pezzi per scatola
Pieces for box

Mosaico 36T 6

Plume 6

Plume mix 6

Patchy 6

Curtain 6

Veneziano 2

MOSAICO 36T, PLUME, PLUME MIX, PATCHY, CURTAIN:

Decoro su rete | Mesh-backed decoration | Dekor auf netz | Décor sur filet | Decoración en red | Декор в сетку | 网板背帖装饰件

Una nuova proposta decorativa che esalta le superfici, per un effetto dalla profondità sorprendente.

A new decorative effect that brings out the astonishing depth of our surfaces.

Lace SP RECT
1200x2780 / 48"x110"



Nube **VV 03**

Lace SP RECT
1200x2780 / 48"x110"



Alba **VV 07**



CARATTERISTICHE TECNICHE

Technical specifications | Technische Eigenschaften | Caractéristiques techniques | Características técnicas | Технические характеристики | 技术特征

STANDARD EN 14411 - G

	CARATTERISTICHE TECNICHE TECHNICAL DATA TECHNISCHE DATEN CARACTERISTIQUES TECHNIQUES CARACTERÍSTICAS TÉCNICAS ТЕХНИЧЕСКИЕ ХАРАКТЕРИСТИКИ 技术特征	NORMA STANDARD NORM NORME NORMA ЗНАЧЕНИЯ 标准	VALORI PRESCRITTI DALLE NORME EN 14411 - G INTERNATIONAL STANDARDS EN 14411 - G INTERNATIONALE NORMWERTE EN 14411 - G VALEURS PREVUES PAR LES NORMES EN 14411 - G VALORES PREVISTOS POR LAS NORMAS EN 14411 - G ПРЕДУСМОТРЕННЫЕ СТАНДАРТОМ EN 14411-G EN 14411 - G标准规定值	*VALORE MEDIO MIRAGE MIRAGE AVERAGE VALUE MIRAGE MITTELWERT VALEURS MOYEN MIRAGE VALORES MEDIO MIRAGE СРЕДНЕЕ ЗНАЧЕНИЕ MIRAGE MIRAGE平均值
	CARATTERISTICHE DIMENSIONALI - SIZE CHARACTERISTICS - MASSEIGENSCHAFTEN DETERMINATION DES CARACTERISTIQUES DIMENSIONNELLES - CARACTERÍSTICAS DIMENSIONALES - РАЗМЕРНЫЕ ХАРАКТЕРИСТИКИ - 尺寸特征			
	LATI SIDES - SEITEN COTES - CANTOS РАЗМЕРЫ СТОРОН - 側邊	EN ISO 10545-2	± 0,3% MAX (± 1,0 mm MAX)	CONFORME COMPLYING
	SPESSORE THICKNESS - DICKE EPAISSEUR - ESPESOR ТОЛЩИНА - 厚度	EN ISO 10545-2	± 5,0% MAX (± 0,5 mm MAX)	CONFORME COMPLYING
	RETTILINEITÀ DEGLI SPIGOLI STRAIGHTNESS OF SIDES - GERADLINIGKEIT DER KANTEN RECTITUDE DES ARETES - RECTITUD DE LOS CANTOS КОСОУГОЛЬНОСТЬ - 边角平直度	EN ISO 10545-2	± 0,3% MAX (± 0,8 mm MAX)	CONFORME COMPLYING
	ORTOGONALITÀ RECTANGULARITY - RECHTWINKLIGKEIT PERPENDICULARITÉ - ORTOGONALIDAD КРИВИЗНА СТОРОН - 直角度	EN ISO 10545-2	± 0,3% MAX (± 1,5 mm MAX)	CONFORME COMPLYING
	PLANARITÀ SURFACE FLATNESS - EBENFLÄCHIGKEIT PLANEITE DE SURFACE - PLANEIDAD КРИВИЗНА ЛИЦЕВОЙ ПОВЕРХНОСТИ - 平整度	EN ISO 10545-2	± 0,4% MAX (± 1,8 mm MAX)	CONFORME COMPLYING
	ASSORBIMENTO D'ACQUA WATER ABSORPTION - WASSERAUFNAHME ABSORPTION D'EAU - ABSORCIÓN DE AGUA ВОДОПОГЛОЩЕНИЕ - 吸水率	EN ISO 10545-3	≤ 0,5%	≤ 0,1%
	RESISTENZA ALLA FLESSIONE FLEXION RESISTANCE - BIEGEFESTIGKEIT RESISTANCE A LA FLEXION - RESISTENCIA A LA FLEXIÓN ПРЕДЕЛ ПРОЧНОСТИ ПРИ ИЗГИБЕ - 抗弯强度	EN ISO 10545-4	S ≥ 700 N (< 7,5 mm) S ≥ 1.300 N (> 7,5 mm) R ≥ 35 N/mm².	≧ 6 mm: S ≥ 1100 N R ≥ 45 N/mm² ≧ 9 mm: S ≥ 2.400 N R ≥ 48 N/mm²
	RESISTENZA ALL'URTO IMPACT RESISTANCE - STOSSFESTIGKEIT RESISTANCE AUX CHOCES - RESISTENCIA A LOS GOLPES СТОЙКОСТЬ К ПЕРЕПАДАМ - 抗冲击强度	EN ISO 10545-5	VALORE DICHIARATO DECLARED VALUE	> 0,80
	RESISTENZA ALL'ABRAZIONE ABRASION RESISTANCE - ABRIEBFESTIGKEIT RESISTANCE A L'ABRASION - RESISTENCIA A LA ABRASIÓN СТОЙКОСТЬ К ИСТИРАНИЮ - 耐磨强度	EN ISO 10545-6	≤ 175 mm³	< 150 mm³
	COEFFICIENTE DI DILATAZIONE TERMICA LINEARE COEFFICIENT OF LINEAR THERMAL-EXPANSION - LINEARER WÄRMEAUDEHNUNGSKOEFFIZIENT COEFFICIENT DE DILATATION THERMIQUE LINEAIRE - COEFICIENTE DE DILATACIÓN TÉRMICA LINEAL КОЭФФИЦИЕНТ ЛИНЕЙНОГО ТЕРМИЧЕСКОГО РАСШИРЕНИЯ - 线性热膨胀系数	EN ISO 10545-8	-	α=6,6x10 ⁻⁶ °C ⁻¹
	RESISTENZA AGLI SBALZI TERMICI RESISTANCE TO THERMAL SHOCKS - BESTÄNDIGKEIT GEGEN TEMPERATURSCHWANKUNGEN RESISTANCE AUX CHOCES THERMIQUES - RESISTENCIA A LOS CHOQUES TÉRMICOS СТОЙКОСТЬ К ПЕРЕПАДАМ ТЕМПЕРАТУРЫ - 耐热突变性	EN ISO 10545-9	TEST SUPERATO SECONDO EN ISO 10545-1 PASS ACCORDING EN ISO 10545-1	NESSUN DANNO NO DAMAGE
	RESISTENZA AL GELO FROST RESISTANCE - FROSTBESTÄNDIGKEIT RESISTANCE AU GEL - RESISTENCIA AL HIELO МОРОЗОСТОЙКОСТЬ - 耐冻性	EN ISO 10545-12	TEST SUPERATO SECONDO EN ISO 10545-1 PASS ACCORDING EN ISO 10545-1	NESSUN DANNO NO DAMAGE
	RESISTENZA ALL'ATTACCO CHIMICO RESISTANCE TO CHEMICALS - CHEMIKALIENBESTÄNDIGKEIT RESISTANCE A L'ATTAQUE CHIMIQUE - RESISTENCIA QUÍMICA ХИМИЧЕСКАЯ СТОЙКОСТЬ - 耐化学品作用	EN ISO 10545-13	UB MIN.	A LA HA
	RESISTENZA ALLE MACCHIE RESISTANCE TO STAINS - FLECKENBESTÄNDIGKEIT RESISTANCE AUX TACHES - RESISTENCIA A LAS MANCHAS УСТОЙЧИВОСТЬ К ПЯТНООБРАЗОВАНИЮ - 防污性	EN ISO 10545-14	VALORE DICHIARATO DECLARED VALUE	5
	CESSIONE DI PIOMBO E CADMIO LEAD AND CADMIUM DISCHARGE - ABGABE VON BLEI UND CADMIUM PERTE DE PLOMB ET CADMIUM - CESIÓN DE PLOMO Y CADMIO ВЫДЕЛЕНИЕ СВИНЦА И КАДМИЯ - 铅和镉的排放	EN ISO 10545-15	VALORE DICHIARATO DECLARED VALUE	< AL LIMITE DI RILEVAMENTO < THAN INSTRUMENT LIMIT
				SP NAT ST
			DM 236/89 BCRA	> 0,40 > 0,40 > 0,40
			ANSI A326.3	Wet and Dry ≥ 0,42 ≥ 0,42 ≥ 0,55
			AS 4586	- P2 P3 -
			DIN 51130	- R9 R10 R11
			DIN 51097	- - A+B A+B+C
			UNE 41901	≥ CL1 CL1 CL1 CL3
			BS 7976 sl.96-4S	Wet and Dry - ≥ 0,36 ≥ 0,36
			BS 7976 sl.55-TRL	Wet and Dry - ≥ 0,36 ≥ 0,36
	SCIVOLOSITÀ SKID RESISTANCE - RUTSCHWERT GLISSANCE - ADHERENCIA СКОЛЬЗКОСТЬ - 防滑性			

Per i certificati specifici, contattare Mirage SpA - For specific certificates, please contact Mirage SpA - Für die speziellen Zertifikate wenden Sie sich bitte an Mirage SpA - Pour les certificats spécifiques, veuillez contacter Mirage SpA - Para los certificados específicos, contactar Mirage SpA - Для сертификатов обращайтесь в компанию Mirage SpA - 关于具体的证书, 请联系Mirage SpA公司



WALL: Eibecio Antico WA 02 1200x2780 / 48"x110" LUC RECT
FLOOR: Eibecio Antico WA 02 1200x2780 / 48"x110" LUC RECT

WANDERLUST

Research and exploration are the key concepts of a voyage of discovery through new material inspirations.

From Italy to France, from Brazil to Mexico and on to Madagascar, in search of uniquely beautiful elements comprised in a container of exclusive porcelain stoneware marbles.



WALL: Calacatta Copper WA 01 1200x2780 / 48"x110" LUC RECT

COLORI

Colours | Farben | Couleurs | Colores | Цветов | 种颜色



WALL: Saint Laurent **WA 07** 1200x2780 / 48"x110" LUC RECT
 FLOOR: GLOCAL Ideal **GC 03** 1200x1200 / 48"x48" SP RECT
 FURNITURE: JURUPA Wild **JP 05** 200x1200 / 8"x48" SP RECT



Calacatta Copper
WA 01



Libeccio Antico
WA 02



Onice Brown
WA 03



Azul Puro
WA 04



Labradorite
WA 05



Dark Cosmo
WA 06

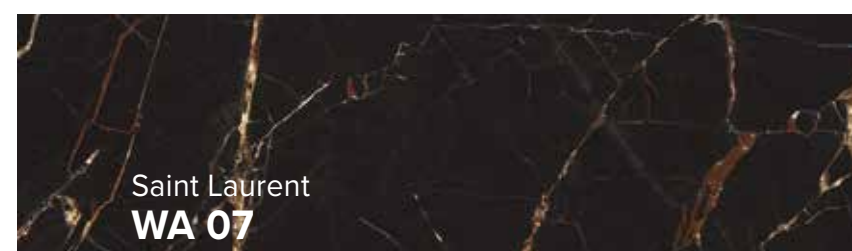

Saint Laurent
WA 07



Agata Blue
WA 08



Agata Multicolor
WA 09



Agata Black
WA 10



Siberian Malachite
WA 11



Galway Green
WA 12

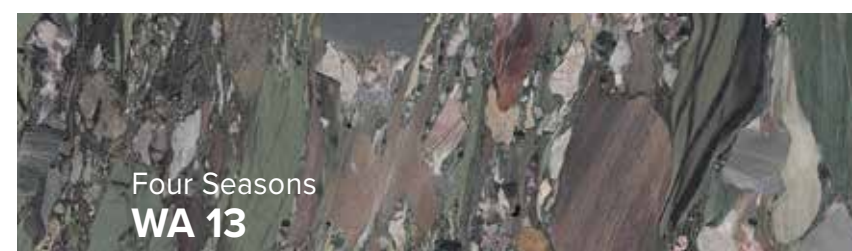

Four Seasons
WA 13



WALL: Four Seasons **WA 13** 1200x2780 / 48"x110" LUC RECT
FLOOR: CLAY Fancy **CL 04** 800x800 / 31½"x31½" SP RECT
COUNTER and TABLE: Four Seasons **WA 13** LUC



WALL: Agata Multicolor **WA 09** 1200x2780 / 48"x110" LUC RECT
 FLOOR: CLAY Verve **CL 05** 600x600 / 24"x24" SP RECT











WALL: Onice Brown **WA 03** 1200x2780 / 48"x110" LUC RECT
 FLOOR: COSMOPOLITAN White Crystal **CP 05** 1200x1200 / 48"x48" LUC RECT
 COUNTER: Saint Laurent **WA 07** LUC

COLORI

Colours | Farben | Couleurs | Colores | Цветов | 种颜色









CALACATTA COPPER **WA 01**



	Formati Nominali		Superficie		Spessore mm	
	Nominal Sizes					
	1200x2780 / 48"x110"		LUC RECT		6	
	Stucchi consigliati					
	Recommended grouts					
	KERAKOLL	43				
	MAPEI	132 Beige 2000				
	LATICRETE	17 Marble Beige				









LIBECCIO ANTICO **WA 02**



	Formati Nominali		Superficie		Spessore mm	
	Nominal Sizes					
	1200x2780 / 48"x110"		LUC RECT		6	
	Stucchi consigliati					
	Recommended grouts					
	KERAKOLL	34				
	MAPEI	142 Marrone				
	LATICRETE	58 Terracotta				







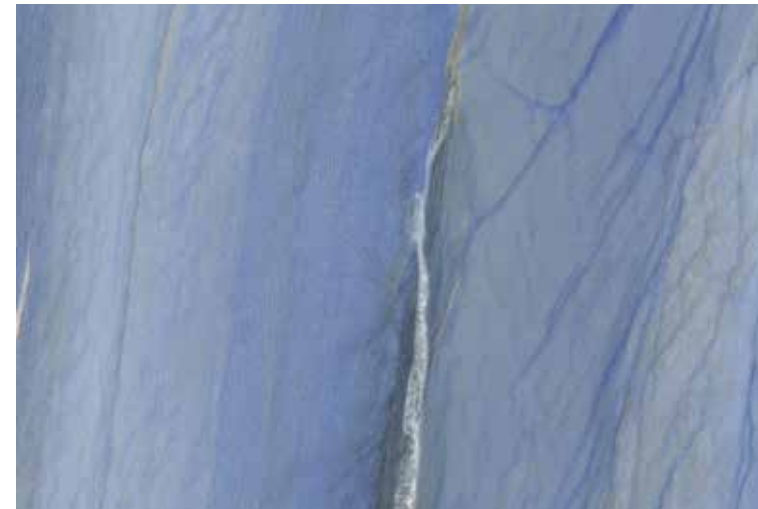

ONICE BROWN **WA 03**



	Formati Nominali		Superficie		Spessore mm	
	Nominal Sizes					
	1200x2780 / 48"x110"		LUC RECT		6	
	Stucchi consigliati					
	Recommended grouts					
	KERAKOLL	36				
	MAPEI	136 Fango				
	LATICRETE	35 Mocha				







AZUL PURO **WA 04**

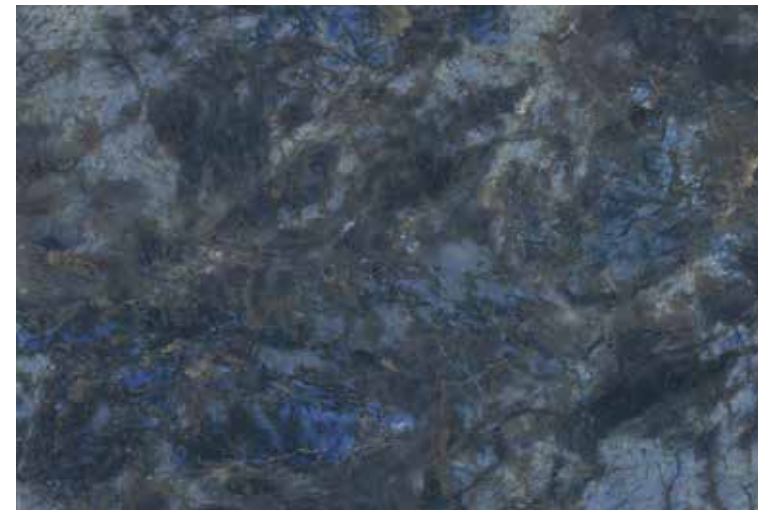

	Formati Nominali		Superficie		Spessore mm	
	Nominal Sizes					
	1200x2780 / 48"x110"		LUC RECT		6	
	Stucchi consigliati					
	Recommended grouts					
	KERAKOLL	14				
	MAPEI	172 Blu Spazio				
	LATICRETE	91 Slate Grey				





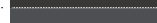
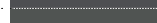

LABRADORITE **WA 05**



	Formati Nominali		Superficie		Spessore mm	
	Nominal Sizes					
	1200x2780 / 48"x110"		LUC RECT		6	
	Stucchi consigliati					
	Recommended grouts					
	KERAKOLL	11				
	MAPEI	114 Antracite				
	LATICRETE	45 Raven				

DARK COSMO **WA 06**



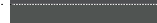



	Formati Nominali		Superficie		Spessore mm	
	Nominal Sizes					
	1200x2780 / 48"x110"		LUC RECT		6	
	Stucchi consigliati					
	Recommended grouts					
	KERAKOLL	11				
	MAPEI	114 Antracite				
	LATICRETE	45 Raven				

COLORI

Colours | Farben | Couleurs | Colores | Цветов | 种颜色

SAINT LAURENT **WA 07**







	Formati Nominali Nominal Sizes		Superficie Finish		Spessore mm Thickness mm
	1200x2780 / 48"x110"		LUC RECT		6
	Stucchi consigliati Recommended grouts				
	KERAKOLL	11			
	MAPEI	114 Antracite			
	LATICRETE	45 Raven			



AGATA BLUE **WA 08**







	Formati Nominali Nominal Sizes		Superficie Finish		Spessore mm Thickness mm
	1200x2780 / 48"x110"		LUC RECT		6
	Stucchi consigliati Recommended grouts				
	KERAKOLL	14			
	MAPEI	172 Blu Spazio			
	LATICRETE	91 Slate Grey			



AGATA MULTICOLOR **WA 09**







	Formati Nominali Nominal Sizes		Superficie Finish		Spessore mm Thickness mm
	1200x2780 / 48"x110"		LUC RECT		6
	Stucchi consigliati Recommended grouts				
	KERAKOLL	08			
	MAPEI	112 Grigio Medio			
	LATICRETE	78 Sterling Silver			



AGATA BLACK **WA 10**







	Formati Nominali Nominal Sizes		Superficie Finish		Spessore mm Thickness mm
	1200x2780 / 48"x110"		LUC RECT		6
	Stucchi consigliati Recommended grouts				
	KERAKOLL	11			
	MAPEI	114 Antracite			
	LATICRETE	45 Raven			

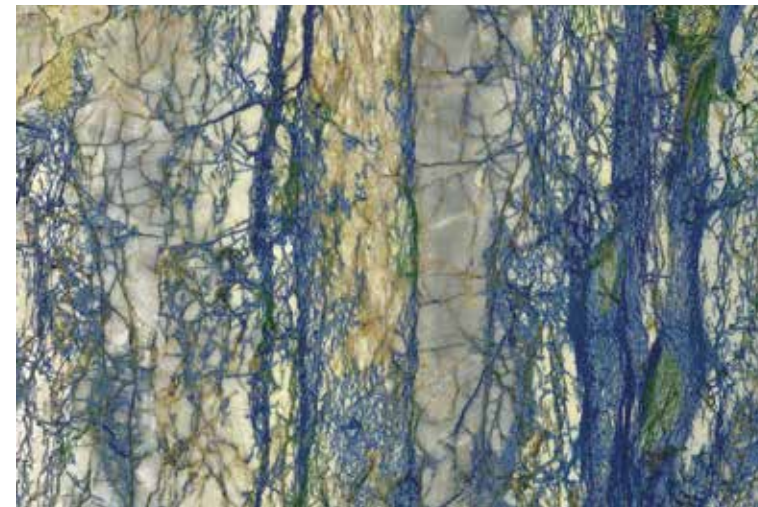

SIBERIAN MALACHITE **WA 11**







	Formati Nominali Nominal Sizes		Superficie Finish		Spessore mm Thickness mm
	1200x2780 / 48"x110"		LUC RECT		6
	Stucchi consigliati Recommended grouts				
	KERAKOLL	08			
	MAPEI	112 Grigio Medio			
	LATICRETE	78 Sterling Silver			



GALWAY GREEN **WA 12**



	Formati Nominali Nominal Sizes		Superficie Finish		Spessore mm Thickness mm
	1200x2780 / 48"x110"		LUC RECT		6
	Stucchi consigliati Recommended grouts				
	KERAKOLL	18			
	MAPEI	115 Grigio Fiume			
	LATICRETE	24 Natural Grey			







COLORI

Colours | Farben | Couleurs | Colores | Цветов | 种颜色

FOUR SEASONS **WA 13**























	Formati Nominali Nominal Sizes		Superficie Finish		Spessore mm Thickness mm
	1200x2780 / 48"x110"		LUC RECT		6
	Stucchi consigliati Recommended grouts				
	KERAKOLL	11			
	MAPEI	114 Antracite			
	LATICRETE	45 Raven			



RIASSUNTIVO FORMATI ED IMBALLI

Summary of sizes and packaging | Übersicht über Formate und Verpackungen | Récapitulatif formats et emballages
Sinóptico de formatos y embalajes | Краткая информация о форматах и упаковках | 规格和包装概述

	Formati Nominali Nominal Sizes	1200x2780 48"x110"	
	Tutti i formati sono rettificati. All sizes are rectified.		
	Superficie Finish	LUC	
	CALACATTA COPPER WA 01	V2	■
	LIBECCIO ANTICO WA 02	V2	■
	ONICE BROWN WA 03	V2	■
	AZUL PURO WA 04	V2	■
	LABRADORITE WA 05	V2	■
	DARK COSMO WA 06	V2	■
	SAINT LAURENT WA 07	V2	■
	AGATA BLUE WA 08	V2	■
	AGATA MULTICOLOR WA 09	V2	■
	AGATA BLACK WA 10	V2	■
	SIBERIAN MALACHITE WA 11	V2	■
	GALWAY GREEN WA 12	V2	■
	FOUR SEASONS WA 13	V2	■
	Peso lordo per scatola Gross weight per box		
	Pezzi per scatola Pieces for box		
	mq. scatola sqm. box		
	Scatole / Full pallet boxes / Full pallet	Please refer to page 588	
	mq. pallet sqm. pallet		

Per tutti i grandi formati è possibile prevedere, su richiesta, l'applicazione di una stuoia in fibra di vetro.
For big sizes, a fibreglass mat can be applied on request.

ACCORGIMENTI SPECIFICI PER L'APPLICAZIONE DELLE GRANDI LASTRE IN 6 MM DI SPESSORE: p. 582 | Precautions for 6mm big slabs applications: page 582 | spezifische Anweisungen zur Nutzung der Grossformate in 6mm: seite 582 | Precauciones específicas para la aplicación de las grandes placas en 6 mm de espesor: page 582 | Precautions spécifiques pour la pose des grandes plaques en 6mm d'épaisseur: página 582 | специальные предосторожности для укладки больших плит толщиной 6 мм : страница 582

/MY NOTES

.....

.....

.....

.....

.....

 **Maggiori informazioni**
More information





WALL: Labradorite **WA 05** 1200x2780 / 48"x110" LUC RECT
 FLOOR: COSMOPOLITAN Calacatta Gold **CP 02** 1200x1200 / 48"x48" LUC RECT

CARATTERISTICHE TECNICHE

Technical specifications | Technische Eigenschaften | Caractéristiques techniques | Características técnicas | Технические характеристики | 技术特征

STANDARD EN 14411 - G

	CARATTERISTICHE TECNICHE TECHNICAL DATA TECHNISCHE DATEN CARACTERISTIQUES TECHNIQUES CARACTERÍSTICAS TÉCNICAS ТЕХНИЧЕСКИЕ ХАРАКТЕРИСТИКИ 技术特征	NORMA STANDARD NORM NORME NORMA НОРМА ЗНАЧЕНИЯ 标准	VALORI PRESCRITTI DALLE NORME EN 14411 - G INTERNATIONAL STANDARDS EN 14411 - G INTERNATIONALE NORMWERTE EN 14411 - G VALEURS PREVUES PAR LES NORMES EN 14411 - G VALORES PREVISTOS POR LAS NORMAS EN 14411 - G ПРЕДУСМОТРЕННЫЕ СТАНДАРТОМ EN 14411-G EN 14411 - G标准规定值	VALORE MEDIO MIRAGE MIRAGE AVERAGE VALUE MIRAGE MITTELWERT VALEURS MOYEN MIRAGE VALOR MEDIO MIRAGE СРЕДНЕЕ ЗНАЧЕНИЕ MIRAGE MIRAGE平均值
	CARATTERISTICHE DIMENSIONALI - SIZE CHARACTERISTICS - MASSEIGENSCHAFTEN DETERMINATION DES CARACTERISTIQUES DIMENSIONNELLES - CARACTERÍSTICAS DIMENSIONALES - РАЗМЕРНЫЕ ХАРАКТЕРИСТИКИ - 尺寸特征			LUC (GL)
	LATI SIDES - SEITEN COTES - CANTOS РАЗМЕРЫ СТОРОН - 侧边	EN ISO 10545-2	± 0,3% MAX (± 1,0 mm MAX)	CONFORME COMPLYING
	SPESSORE THICKNESS - DICKE ÉPAISSEUR - ESPESOR ТОЛЩИНА - 厚度	EN ISO 10545-2	± 5,0% MAX (± 0,5 mm MAX)	CONFORME COMPLYING
	RETTILINEITÀ DEGLI SPIGOLI STRAIGHTNESS OF SIDES - GERADLINIGKEIT DER KANTEN RECTITUDE DES ARETES - RECTITUD DE LOS CANTOS КОСОУГОЛЬНОСТЬ - 边角平直度	EN ISO 10545-2	± 0,3% MAX (± 0,8 mm MAX)	CONFORME COMPLYING
	ORTOGONALITÀ RECTANGULARITY - RECHTWINKLIGKEIT PERPENDICULARITE - ORTOGONALIDAD КРИВИЗНА СТОРОН - 直角度	EN ISO 10545-2	± 0,3% MAX (± 1,5 mm MAX)	CONFORME COMPLYING
	PLANARITÀ SURFACE FLATNESS - EBENFLÄCHIGKEIT PLANEITE DE SURFACE - PLANEIDAD КРИВИЗНА ЛИЦЕВОЙ ПОВЕРХНОСТИ - 平整度	EN ISO 10545-2	± 0,4% MAX (± 1,8 mm MAX)	CONFORME COMPLYING
	ASSORBIMENTO D'ACQUA WATER ABSORPTION - WASSERAUFNAHME ABSORPTION D'EAU - ABSORCIÓN DE AGUA ВОДОПОГЛОЩЕНИЕ - 吸水率	EN ISO 10545-3	≤ 0,5%	≤ 0,1%
	RESISTENZA ALLA FLESSIONE FLEXION RESISTANCE - BIEGEFESTIGKEIT RESISTANCE A LA FLEXION - RESISTENCIA A LA FLEXIÓN ПРЕДЕЛ ПРОЧНОСТИ ПРИ ИЗГИБЕ - 抗弯强度	EN ISO 10545-4	S ≥ 700 N (< 7,5 mm) S ≥ 1.300 N (> 7,5 mm) R ≥ 0,48 N/mm ² .	≥ 6 mm: S≥1.300N R≥45 N/mm ²
	RESISTENZA ALL'URTO IMPACT RESISTANCE - STOSSFESTIGKEIT RESISTANCE AUX CHOCS - RESISTENCIA A LOS GOLPES УДАРСТОЙКОСТЬ - 抗冲击强度	EN ISO 10545-5	VALORE DICHIARATO DECLARED VALUE	> 0,80
	RESISTENZA ALL'ABRASIONE ABRASION RESISTANCE - ABRIEBFESTIGKEIT RESISTANCE A L'ABRASION - RESISTENCIA A LA ABRASIÓN СТОЙКОСТЬ К ИСТИРАНИЮ - 耐磨强度	EN ISO 10545-6	≤ 175 mm ³	< 150 mm ³
	COEFFICIENTE DI DILATAZIONE TERMICA LINEARE COEFFICIENT OF LINEAR THERMAL-EXPANSION - LINEARER WÄRMEAUDEHNUNGSKOEFFIZIENT COEFFICIENT DE DILATATION THERMIQUE LINEAIRE - COEFICIENTE DE DILATACION TERMICA LINEAL КОЭФФИЦИЕНТ ЛИНЕЙНОГО ТЕРМИЧЕСКОГО РАСШИРЕНИЯ - 线性热膨胀系数	EN ISO 10545-8	-	α 6,2x10 ⁻⁶ °C ⁻¹
	RESISTENZA AGLI SBALZI TERMICI RESISTANCE TO THERMAL SHOCKS - BESTÄNDIGKEIT GEGEN TEMPERATURSCHWANKUNGEN RESISTANCE AUX CHOCS THERMIQUES - RESISTENCIA A LOS CHOQUES TÉRMICOS СТОЙКОСТЬ К ПЕРЕПАДАМ ТЕМПЕРАТУРЫ - 耐热突变性	EN ISO 10545-9	TEST SUPERATO SECONDO EN ISO 10545-1 PASS ACCORDING EN ISO 10545-1	NESSUN DANNO NO DAMAGE
	RESISTENZA AL GELO FROST RESISTANCE - FROSTBESTÄNDIGKEIT RESISTANCE AU GEL - RESISTENCIA AL HIELO МОРОЗОСТОЙКОСТЬ - 耐冻性	EN ISO 10545-12	TEST SUPERATO SECONDO EN ISO 10545-1 PASS ACCORDING EN ISO 10545-1	NESSUN DANNO NO DAMAGE
	RESISTENZA ALL'ATTACCO CHIMICO RESISTANCE TO CHEMICALS - CHEMIKALIENBESTÄNDIGKEIT RESISTANCE A L'ATTAQUE CHIMIQUE - RESISTENCIA QUIMICA ХИМИЧЕСКАЯ СТОЙКОСТЬ - 耐化学作用	EN ISO 10545-13	B MIN.	A LA
	RESISTENZA ALL'ABRASIONE SUPERFICIALE SURFACE ABRASION RESISTANCE - ABRIEBFESTIGKEIT DER OBERFLÄCHE RESISTANCE À L'ABRASION SUPERFICIELLE - RESISTENCIA A LA ABRASIÓN SUPERFICIAL ХИМИЧЕСКАЯ СТОЙКОСТЬ - 耐表面磨损	EN ISO 10545-7	-	LUC PEI 5 (WA 01) PEI 4 (WA 04-09-10) PEI 3 (WA 02-03-05-06-07-08)
	RESISTENZA ALLE MACCHIE RESISTANCE TO STAINS - FLECKENBESTÄNDIGKEIT RESISTANCE AUX TACHES - RESISTENCIA A LAS MANCHAS УСТОЙЧИВОСТЬ К ПЯТНООБРАЗОВАНИЮ - 防污性	EN ISO 10545-14	VALORE DICHIARATO DECLARED VALUE	5
	CESSIONE DI PIOMBO E CADMIO LEAD AND CADMIUM DISCHARGE - ABGABE VON BLEI UND CADMIUM PERTE DE PLOMB ET CADMIUM - CESIÓN DE PLOMO Y CADMIO ВЫДЕЛЕНИЕ СВИНЦА И КАДМИЯ - 铅和镉的排放	EN ISO 10545-15	VALORE DICHIARATO DECLARED VALUE	< AL LIMITE DI RILEVAMENTO < THAN INSTRUMENT LIMIT
				LUC
		DM 236/89 BCRA	> 0,40	-
		ANSI A326.3	Wet and Dry	-
		AS 4586	-	-
		DIN 51130	-	-
		DIN 51097	-	-
		UNE 41901	≥ CL1	-
		BS 7976 sl.96-4S	Wet and Dry	-
		BS 7976 sl.55-TRL	Wet and Dry	-
	SCIVOLOSITÀ SKID RESISTANCE - RUTSCHWERT GLISSANCE - ADHERENCIA СКОЛЬЗКОСТЬ - 防滑性			

Per i certificati specifici, contattare Mirage SpA - For specific certificates, please contact Mirage SpA - Für die speziellen Zertifikate wenden Sie sich bitte an Mirage SpA - Pour les certificats spécifiques, veuillez contacter Mirage SpA - Para los certificados específicos, contactar Mirage SpA - Для сертификатов обращайтесь в компанию Mirage SpA - 关于具体的证书,请联系Mirage SpA公司

TECHNICAL INFORMATIONS

Mirage® informa | Mirage® informiert | Mirage® informe
Mirage® informa | Mirage® сообщает | Mirage® 通知

CERTIFICAZIONI

Certifications | Zertifizierung | Certifications | Certificaciones | Сертификаты | 认证

Certificazioni di sistema
System certifications
Zertifizierung des Systems
Certifications de système
Certificaciones de sistema
Сертификаты на систему
体系认证

DNV



Certificazioni di prodotto
Product certifications
Zertifizierung der Produkte
Certifications de produits
Certificaciones de producto
Сертификаты на продукцию
产品认证

PB

POLONIA



PN

POLONIA



CSTB

FRANCE



<https://evaluation.cstb.fr/fr/rechercher/>

CCC

CHINA



WCM

MALAYSIA



WCM

MALAYSIA



LA MARCATURA CE

The CE Marking | Die CE-Kennzeichnung | Le marquage CE | El marcado CE | Маркировка CE

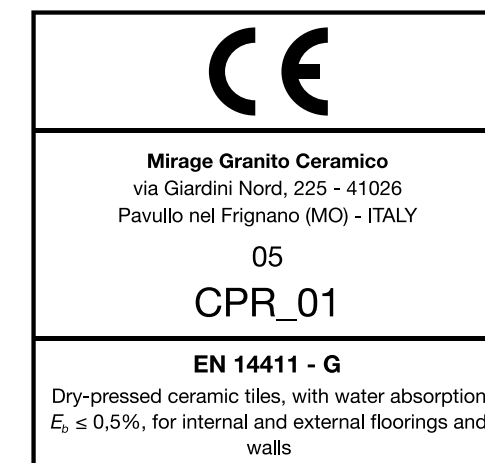

CARATTERISTICHE TECNICHE SPECIFICHE DISPONIBILI SU RICHIESTA
SPECIFIC TECHNICAL CHARACTERISTICS AVAILABLE ON DEMAND

In conformità con la **Direttiva 305/2011** sui Prodotti da Costruzione, il **Marchio CE** è apposto come segno della conformità ai requisiti essenziali di sicurezza del prodotto; la marcatura CE è **condizione necessaria** per l'immissione di un prodotto sul mercato europeo.

[EN]
In conformity with the **Directive 305/2011** on the Construction Products, the **CE Mark** is affixed as conformity sign to the essential safety requirements of the product; the CE Marking is an **essential condition** for the product introduction on the European market.

[DE]
Im Einklang mit der **Richtlinie 305/2011** über Bauprodukte wird das **CE-Zeichen** als Zeichen für die Konformität mit den grundlegenden Sicherheitsanforderungen des Produkts angebracht; die CE-Kennzeichnung ist **Pflichtvoraussetzung** für das Inverkehrbringen eines Produkts auf dem europäischen Markt.

[FR]
Comme exigé par la **Directive 305/2011** sur les produits de construction, le **marquage CE** est apposé comme preuve de conformité du produit aux **exigences essentielles** de sécurité : le label est la condition nécessaire de sa mise sur le marché européen.

[ES]
De conformidad con la **Directiva 305/2011** sobre los Productos de Construcción, la **Marca CE** es colocada para garantizar la conformidad con los **requisitos esenciales** de seguridad del producto; la marca CE es una condición necesaria para comercializar un producto en el mercado europeo.

[RU]
В соответствии с **Директивой 305/2011** по Строительным материалам **Знак CE** ставится для обозначения соответствия основным требованиям по безопасности изделия; наличие маркировки CE является **необходимым условием** для ввода товара на европейский рынок.

Per ulteriori informazioni potete rivolgervi al vostro rivenditore MIRAGE o direttamente a:

For additional information contact your MIRAGE dealer or:
Für weitere Informationen wenden Sie sich bitte an Ihren MIRAGE-Händler oder direkt an:
Pour toute le information ultérieure adressez-vous a votre revendeur MIRAGE ou directement à:
Para más información diríjase a su distribuidor MIRAGE o bien directamente a:
Для дальнейшей информации можете обратиться к вашему дистрибутору MIRAGE или непосредственно в:

MIRAGE GRANITO CERAMICO S.p.A.

Via Giardini Nord, 225 - 41026 Pavullo nel Frignano (MO) - ITALY

Tel. 0536 29611 (10 linee)

Internet: www.mirage.it e-mail: info@mirage.it

CARATTERISTICHE TECNICHE

Technical specifications | Technische Eigenschaften | Caractéristiques techniques | Características técnicas | Технические характеристики | 技术特征

TECHNICAL SPECIFICATIONS**WATER ABSORPTION
ISO 10545-3**

Mirage markets materials that offer minimum rates of absorption, achieved by applying stringent production and quality standards to safeguard a compact product with a low degree of porosity. The figure in the tables of specifications is the percentage of water absorption with reference to the mass.

**BENDING STRENGTH
ISO 10545-4**

The figure shown refers to the analysis of the tile's capacity to withstand static and dynamic stress in test conditions.

**RESISTANCE TO ABRASION
ISO 10545-6**

This test is done on unglazed surfaces (UGL) and aims to determine the quantity of material removed by the action of an abrasive disc (150 revs). The less material removed by the disc implies a stronger ceramic product.

**FROST RESISTANCE
ISO 10545-12**

Outdoor products are particularly susceptible to the damage that can be caused by frost and a tile may crack if any water it has absorbed turns into ice. Mirage products are not affected by frost because of their compact body and low porosity.

**CHEMICAL RESISTANCE
ISO 10545-13**

Laboratory tests using low and high concentrations of acids and bases are able to assess the chemical resistance of glazed (GL) and unglazed (UGL) surfaces. They are classed in the following categories:

Unglazed products (UGL):

A, LA, HA: no visible effect.
B, LB, HB: visible effects on cut edges.
C, LC, HC: visible effects on cut edges, on uncut edges and on the to surface.

Glazed products (GL):

A, LA, HA: no visible effect.
B, LB, HB: alteration of the surface appearance.
C, LC, HC: partial or total loss of the original surface.

**SLIPPERINESS****1_DIN 51130**

In this test, an operator stands on a horizontal tiled surface that has been oiled. The operator, wearing special footwear, remains on the surface while it is being tilted until he begins to slip. The following classification is determined by the angle of the tiled surface when he starts slipping:

a <6°	not classified
6° ≤ a ≤10°	R9
10° ≤ a ≤19°	R10
19° ≤ a ≤27°	R11
27° ≤ a ≤35°	R12
a >35°	R13

2_DIN 51097

This process is used to determine if tiles are suitable for use in areas where people will walk barefoot. The tiles are fitted on a horizontal surface and are wet with a solution (1 g/l of wetting agent + water). The operator (who is barefoot), stands on the surface while it is being tilted until he begins to slip: the angle when the slipping starts determines the following classification:

a <12°	not classified
12° ≤ a ≤18°	A
18° ≤ a ≤24°	B (A+B)
a ≤24°	C (A+B+C)

**RESISTANCE TO STAINS
ISO 10545-14**

Three different elements (oil, iodine solution and chrome green) are placed in contact with the tile for 24 hours, after which it is cleaned:

CLASS 5
The stain is removed by means of running hot water applied for 5 minutes.

CLASS 4
The stain is removed with the help of a weak neutral detergent and a non-abrasive sponge.

CLASS 3
The stain is removed using an alkaline detergent containing abrasives and a rotating brush with hard bristles.

CLASS 2
The stain is removed using a specific solvent, left on the stain for 24 hours.

CLASS 1
The stain is not removed

PORCELAIN STONEWARE FEATURES

Mirage porcelain stoneware is a totally natural product. The controlled random mix of natural raw materials in different colours overcomes the typical repetition of artificial products: every slab is unique in terms of grain and colour combination, without any of the typical excesses of many natural stones.

- Basic sizes and special pieces can be supplied in autonomous colours. Any small variations in calibre fall within legal tolerances.

- Occasional light spotting is part of the natural feature of the material;

- Seconds or end-of-production goods are sold "as seen and accepted", and no complaints will be accepted;

- For best results with products with ≥ V2 shading coefficient, lay the material using several boxes, to create a perfect mix.

DOCUMENTATION

Mirage Granito Ceramico SpA reserves the right to vary the products illustrated in this catalogue for production purposes or in order to improve quality. Samples are purely indicative. Packaging and weights shown may be varied in line with production requirements. Check with the sales department at the time of order.

USE AND MAINTENANCE INSTRUCTION**LAYING AND CLEANING ADVICE****▲ LAYING**

On receipt of the material, and in any case prior to laying, check the shade, calibre and choice of materials carefully, as claims will not be accepted on laid materials, as any defects are visible prior to laying.

To obtain the best possible visual results for products with ≥ V2 shading coefficient, lay the materials taking the tiles from several different boxes in order to achieve the best possible mix. For grained products, such as natural stone, arrange the grain so as to create the best possible visual and colour effect. Laying can be done using both with a dusting of cement, or glue, using special high performance glues for porcelain stoneware. Glue laying is recommended as it offers higher guarantees of stability, particularly for large sizes (more than 45 x 45). Remember that, when laying, the underfloor must be stable, dry and mature, neither frozen nor excessively hot; in any case follow the instructions provided by the manufacturers of the underfloor materials and glues used. Cement-based adhesives must be applied at room temperature, generally between +5° C and +30/35° C.

When laying, comply with the technical laying times indicated by the manufacturers of the glue used. The most suitable glues for laying Mirage porcelain stoneware are identified according to the current European Standard EN12004. When laying, do not mark the surface of the material used with pencils (lead) or indelible markers, particularly when using polished products. Although Mirage products are highly resistant, they may be shaped (to create work tops, stairs, etc.), drilled for the installation of plumbing systems, etc., using diamond tipped discs and special equipment for porcelain stoneware.

▲ JOINTS AND GROUTING

The width of the gap may vary depending on the size of the tiles and the use of the floor being tiled. Laying without a gap is not recommended; lay the tiles with a minimum gap of 2-3 mm (this allows the grout to grip better to the side of the tiles, increasing the absorption of any movement in the underfloor and the compensation of the slabs). In large areas, the expansion joints must be laid regularly; for smaller areas, leave a small gap between the tiles and the perimeter walls. Skirting will cover the gap and assure a finished appearance. In any case follow the advice of the designer/work site manager.

When using epoxy grouts, resins or similar, carry out a cleaning test prior to laying. For a better appearance, use grouts in coordinated colours to the tile in order to reduce contrast (e.g. white tile black grout) particularly for lapped and polished products. After grouting porcelain stoneware tiles, while the grout is still fresh it is important to remove any excess grout immediately and carefully using a sponge and plenty of water. It is in any case indispensable, a few days after laying, to deep clean the surface using buffered acids (follow after-laying instructions) in order to dissolve and remove all working residues. The following products may be used:

- DETERDEK FILA INDUSTRIA CHIMICA - www.filachim.com
- DELTA PLUS KERAKOLL - www.kerakoll.com
- KERANET MAPEI - www.mapei.it
- SERVICE SOLVACID GEAL - www.geal-chim.it
- DISYSCOTT FABER - www.faberchimica.com
- BONACLEAN BONASYSTEM - www.bonasySTEMitalia.it
- STONETECH® CLEANER ACID - LATICRETE - www.laticrete.com

▲ CLEANING AFTER LAYING

Once the work has been completed, correct cleaning is compulsory. The late or improper removal of grout residues may leave stains which are difficult to remove, creating a cement film on the floor which absorbs all kinds of dirt, giving the impression that the tiles are dirty. It is indispensable to dissolve and remove these residues completely using buffered acids diluted in water (follow the instructions on the packs of the products used), which must then be removed completely and quickly, rinsing the floor with plenty of water to avoid residues or drops on the floor which could damage the tiles. Leave the product to take effect on the wet floor, do not allow to dry, and rub with colour-free cloths, then rinse with plenty of water and check that the floor is free from detergent residues. If necessary, repeat the operation.

We recommend a preliminary wash on a sample surface area of a few square metres; if successful, proceed with cleaning the whole surface.

After washing, an alkaline or basic wash must be carried out using degreasing detergents. This is because the acid wash may make the floor sticky, which could cause it to retain dirt. More specifically, Mirage recommends particular care with CP, WA, JW and OX 01 NAT when using buffered acids for cleaning: these materials could damage the surface if not removed in a short time and if traces or drops of the water-acid compound used for cleaning after laying are not removed quickly. All LUC surface finishes require the use of non-abrasive tools during cleaning, in order to avoid opacification and scratching of the LUC finish.

▲ DAILY CLEANING

After deep cleaning after laying (previous chapter), for everyday cleaning **we strongly advise against the use of waxes, oil soap, stains and other treatments (water-oil repellents) on porcelain stoneware**, as these are not necessary. Often, some detergents available on the market contain wax or polishing additives, which after several washes may leave a shiny film on the floor. Sometimes a drop of liquid such as Coca Cola, water, wine etc...may be sufficient to remove this film and restore the original appearance of the tile, causing stains in some areas. With waxes, first of all dewax the floor using specific products to remove the applied wax, following the instructions given by the manufacturer. For films left by soap, lime scale, dirt, use an acid detergent, suitably diluted in water (read the product instructions carefully). It should be noted that **Hydrofluoric acid (HF)** and derivatives may cause irreparable damage to porcelain stoneware. **For routine cleaning, Mirage recommends the use of bleach or ammonia, suitably diluted in water;** for polished porcelain stoneware, dry the floor after washing to prevent unsightly smudges.

▲ EXTRAORDINARY CLEANING

For stubborn stains, use specific products, as shown in the "cleaning products" table on page 570. Do not forget that it is **easier to remove stains when they are still fresh**. Always test a small piece before using detergent products, particularly on lapped or polished porcelain stoneware.

▲ RAISED FLOORS

The use of large amounts of water is not permitted on raised floors; make sure the cloth is well wrung before use. Routing cleaning can be done with special cloths, warm water and detergent, using as little water as possible on the panel. Use concentrated products directly on stains.

TECHNICAL FEATURES**DESCRIPTION OF THE MATERIAL**

Fine superior quality porcelain stoneware, with full-body uniformity
Producer: MIRAGE® GRANITO CERAMICO® SpA, Pavullo (MO) – (ITALY)

Granito Ceramico slabs, compact body, made from noble clay, quartz, feldspar and calcined metal oxides (without glue, resins or additives), pressed at 450 kg/cm² and fully sintered at a temperature of 1200 °C.

SURFACE FINISHES

The surface finishes may be:

- 1) Bocciardato
- 2) Silk
- 3) Grip
- 4) Naturale
- 5) Scalpellato
- 6) Radiale
- 7) Matte
- 8) Spazzolato
- 9) Strutturato
- 10) Lucido
- 11) Pearl

The polishing process (10) is carried out mechanically using diamond grinding tools and water, without the use of chemical substances.

SIZES AND TOLERANCES

Sizes are divided by calibre and choice following internal quality standards, which in any case comply with or improve on those laid down in standard EN 14411 - G.

Here below is a list of our average tolerance values:

Length and width	± 0.3%
Thickness	± 5.0%
Straightness of edges	± 0.3%
Wedging	± 0.2%
Planarity	± 0.2%

TECHNICAL DATA (average values)

- Water absorption: < 0.1%
- Bending resistance: 46-65 N/mm²
- Deep abrasion resistance: <147 mm³
- Frost resistance conforming to standard: EN ISO 10545-12
- Chemical resistance conforming to standard: EN ISO 10545-13
- Breaking load (referred to thicknesses of respectively 9 mm – 10 mm – 20 mm): 2000 N - 3000 N - 13000 N

The above technical data refer to prime quality materials and comply with standard EN 14411 (certificates available on request).

Any materials presented as an alternative to Mirage Granito Ceramico must not be produced with surrogate methods and must not have lower technical characteristics.

Request for quotation laying company

Delivery and glue laying, gap width 2/3/4 mm depending on size.

Product: FINE PORCELAIN STONEWARE, fully body uniformity

Colour: _____

Art-Nr.: _____

Size: _____

Surface: _____

Quantity: _____

Unit price: _____

Total price: _____

[ES]

CARATTERISTICHE TECNICHE

Technical specifications | Technische Eigenschaften | Caractéristiques techniques | Características técnicas | Технические характеристики | 技术特征

<p>CARACTERÍSTICAS TÉCNICAS</p>													
													
 ABSORCIÓN DE AGUA ISO 10545-3	 DESLIZAMIENTO												
Mirage propone en el mercado materiales con coeficientes de absorción reducidos al mínimo, gracias a estándares productivos y cualitativos de altísimo nivel que garantizan compacidad y un reducido grado de porosidad. El valor indicado en las tablas técnicas representa el porcentaje de absorción de agua en relación con la masa.	1_DIN 51130 <p>Para realizar esta prueba, un operador se coloca sobre una superficie horizontal revestida de azulejos y rociada de aceite. Dicha superficie es inclinada hasta que el operador, con un calzado específico, empieza a deslizarse. La clasificación consiguiente es establecida por el ángulo de inclinación de la superficie revestida en el momento del deslizamiento:</p> <table> <tbody><tr> <td>a <6°</td> <td>no clasificados</td></tr> <tr> <td>6°≤ a ≤10°</td> <td>R9</td></tr> <tr> <td>10°≤ a ≤19°</td> <td>R10</td></tr> <tr> <td>19°≤ a ≤27°</td> <td>R11</td></tr> <tr> <td>27°≤ a ≤35°</td> <td>R12</td></tr> <tr> <td>a >35°</td> <td>R13</td></tr> </tbody></table>	a <6°	no clasificados	6°≤ a ≤10°	R9	10°≤ a ≤19°	R10	19°≤ a ≤27°	R11	27°≤ a ≤35°	R12	a >35°	R13
a <6°	no clasificados												
6°≤ a ≤10°	R9												
10°≤ a ≤19°	R10												
19°≤ a ≤27°	R11												
27°≤ a ≤35°	R12												
a >35°	R13												
 RESISTENCIA A LA FLEXIÓN ISO 10545-4	2_DIN 51097 <p>Por medio de este procedimiento, se establece la conformidad del azulejo para la colocación en locales en los que se camina con los pies descalzos. Sobre una superficie horizontal, los azulejos colocados se mojan con una solución (1 g/l de agente mojante + agua). Se inclina la superficie hasta que el operador (que camina con los pies descalzos) empieza a deslizarse; los ángulos correspondientes al deslizamiento determinan la siguiente clasificación:</p> <table> <tbody><tr> <td>a <12°</td> <td>no clasificados</td></tr> <tr> <td>12°≤ a ≤18°</td> <td>A</td></tr> <tr> <td>18°≤ a ≤24°</td> <td>B (A+B)</td></tr> <tr> <td>a ≤24°</td> <td>C (A+B+C)</td></tr> </tbody></table>	a <12°	no clasificados	12°≤ a ≤18°	A	18°≤ a ≤24°	B (A+B)	a ≤24°	C (A+B+C)				
a <12°	no clasificados												
12°≤ a ≤18°	A												
18°≤ a ≤24°	B (A+B)												
a ≤24°	C (A+B+C)												
 RESISTENCIA A LA ABRASIÓN ISO 10545-6	 RESISTENCIA A LAS MANCHAS ISO 10545-14												
La prueba se lleva a cabo sobre superficies no esmaltadas (UGL) con el fin de determinar la cantidad de material que se desprende tras la acción de un disco abrasivo (150 vueltas). Cuanto menor es la cantidad del material desprendido por el disco, más resistente es el producto cerámico.	Se ponen en contacto con el azulejo tres elementos distintos (aceite, solución de yodo y verde cromo) durante 24 horas, tras las cuales se procede a la limpieza:												
	CLASE 5 <p>La mancha se elimina con agua caliente utilizada durante 5 minutos.</p> <p>CLASE 4 <p>La mancha se elimina con la ayuda de un detergente neutro débil y de una esponja no abrasiva.</p> <p>CLASE 3 <p>La mancha se elimina con la ayuda de un detergente básico que contiene abrasivo y con un cepillo rotativo de cerdas duras.</p> <p>CLASE 2 <p>La mancha se elimina con la ayuda de un disolvente adecuado dejado 24 horas sobre la mancha.</p> <p>CLASE 1 <p>La mancha no se elimina.</p></p></p></p></p>												
	CLASE 2 <p>La mancha se elimina con la ayuda de un disolvente adecuado dejado 24 horas sobre la mancha.</p> <p>CLASE 1 <p>La mancha no se elimina.</p></p>												
Productos no esmaltados (UGL):													
A, LA, HA: <p>B, LB, HB: <p>C, LC, HC:</p></p>	ningún efecto visible. <p>efectos visibles en los bordes cortados. <p>efectos visibles en los bordes cortados, en los bordes no cortados y en la superficie del azulejo.</p></p>												
Productos esmaltados (GL):													
A, LA, HA: <p>B, LB, HB: <p>C, LC, HC:</p></p>	ningún efecto visible. <p>modificación del aspecto de la superficie. <p>pérdida parcial o total de la superficie original.</p></p>												

CARACTERÍSTICAS DEL GRES PORCELÁNICO

El Gres Porcelánico Mirage es un producto totalmente natural. La mezcla de materias primas naturales en varios colores por casualidad controlada supera la repetitividad típica de los productos artificiales: cada losa es única, por lo tanto, en cuanto a vetas y combinaciones de colores, sin presentar los excesos típicos de muchas piedras naturales.

- Los tamaños básicos y las piezas especiales pueden suministrarse en tonalidades autónomas. Las posibles pequeñas variaciones de calibre están dentro de las tolerancias admitidas;
- Las pequeños puntos presentes a veces forman parte de la naturalidad del material;
- Los productos de segundas calidades o fuera de producción se darán por "totalmente aceptados" y no se aceptarán reclamaciones;
- Para obtener el mejor resultado estético con los productos con un coeficiente de destonificación ≥ V2, colocar el material sacando las piezas de varias cajas, para conseguir así una óptima mezcla.

DOCUMENTACIÓN

Mirage Granito Cerámico S.p.A. se reserva la facultad de aportar variaciones a los productos ilustrados en este catálogo por necesidades de producción o con el fin de mejorar su calidad. Las muestras son puramente indicativas. Los embalajes y pesos indicados podrán variar por necesidades de producción. Consultar con los departamentos comerciales al realizar el pedido.

INSTRUCCIONES DE USO Y MANTENIMIENTO

SUGERENCIAS PARA UNA COLOCACIÓN Y UNA LIMPIEZA CORRECTAS

▲ COLOCACIÓN

Es importante, al recibir el material, y en cualquier caso antes de la colocación, comprobar atentamente el tono, el calibre y la calidad del material, pues no se aceptarán reclamaciones de material una vez colocado y cuyos defectos fueran visibles antes de la colocación.

Para obtener el mejor resultado estético con los productos con un coeficiente de destonificación ≥ V2, colocar el material sacando las piezas de varias cajas, para conseguir así una óptima mezcla. Para los productos con vetas, como las piedras naturales, se recomienda disponer las vetas de las losas de manera que se obtenga el mejor efecto estético y cromático. La colocación podrá efectuarse tanto con capa de cemento como con adhesivo, utilizando adhesivos específicos de elevadas prestaciones para gres porcelánico. Se aconseja la colocación con adhesivo, ya que ofrece mayores garantías de estanqueidad, sobre todo en los tamaños grandes (mayores de 45 x 45). Se recuerda que, al efectuar la colocación, la base deberá ser estable, estar seca y fraguada, no debiendo estar helada ni excesivamente caliente; es necesario, en cualquier caso, seguir las instrucciones de los fabricantes de los materiales para bases y adhesivos específicos utilizados. Los adhesivos a base de cemento deberán aplicarse a temperatura ambiente, y, en general, a una temperatura comprendida entre +5° C y + 30/35° C. También para la colocación se aconseja respetar los tiempos técnicos indicados por los fabricantes de los adhesivos empleados. Para elegir los adhesivos más aptos para la colocación del gres porcelánico Mirage se tendrá en cuenta la normativa europea actualmente en vigor EN12004.

Durante la colocación, es necesario no marcar la superficie de utilización del material con lápices (grafito) o rotuladores indelebles, sobre todo si se trata de productos pulidos. Los productos Mirage, aun siendo materiales muy resistentes, podrán ser perfilados (para realizaciones de encimeras, escaleras, ...) y perforados para el montaje de instalaciones técnico-sanitarias utilizando discos diamantados y equipos especiales para gres porcelánico.

▲ JUNTAS Y REJUNTADOS

La anchura de la junta podrá variar en función de las dimensiones de las baldosas y del uso previsto del pavimento. Se desaconseja la colocación con junta unida; se aconseja efectuar la colocación con una junta mínima de 2-3 mm (este tipo de colocación permite un mayor agarre del material de rejuntado en los lados de las losas, una mayor absorción de posibles movimientos de la base y una compensación de las losas). En los ambientes grandes, es absolutamente necesario disponer juntas de dilatación con regularidad; en los ambientes pequeños, sin embargo, es suficiente dejar una ligera separación entre la parte embaldosada y las paredes perimetrales. El rodapié cubrirá luego esa separación, dando un aspecto de acabado. En cualquier caso, deberán tenerse en cuenta los consejos y sugerencias del proyectista o jefe de obra.

Para la utilización de materiales epoxi de rejuntado, adiciones de resinas o similares, se aconseja efectuar previamente una prueba real de limpieza. Para conseguir un resultado estético mejor, se sugiere utilizar materiales de rejuntado a juego con el color de la baldosa, con el fin de reducir el contraste (por ej. baldosa blanca material de rejuntado negro), sobre todo si se trata productos lapeados y pulidos. Es importante, después del rejuntado de las baldosas de gres porcelánico, y cuando el material de relleno de las juntas todavía está fresco, quitar inmediatamente, con la ayuda de una esponja y agua abundante, el material de relleno en exceso. Es indispensable, de todos modos, algunos días después de la colocación, efectuar una limpieza a fondo con ácidos tamponados (ver indicaciones para después de la colocación), con el fin de disolver y retirar completamente todos los residuos de la obra. Podrán utilizarse productos como:

- DETERDEK
- DELTA PLUS
- KERANET
- SERVICE SOLVACID
- DISYCOTT
- BONACLEAN
- STONETECH® CLEANER ACID - LATICRETE
- FILA INDUSTRIA CHIMICA - www.filachim.com
- KERAKOLL - www.kerakoll.com
- MAPEI - www.mapei.it
- GEAL - www.geal-chim.it
- FABER - www.faberchimica.com
- BONASYSTEM - www.bonasyystemitalia.it
- LATICRETE - www.laticrete.com

▲ LIMPIEZA “DESPUÉS DE LA COLOCACIÓN”

La limpieza “después de la colocación” es obligatoria al final de la obra. Una eliminación inadecuada o tardía de los residuos del material de rejuntado utilizado puede dejar cercos difíciles de quitar y crear sobre el pavimento una película de cemento capaz de absorber toda forma de suciedad, dando así la impresión de que es el material el que se ensucia. Es indispensable disolver y eliminar por completo dichos residuos utilizando ácidos tamponados diluidos en agua (leer las instrucciones de uso en los envases de los productos utilizados), que deberán ser removidos luego totalmente, en breve tiempo, aclarando con agua abundante todo el pavimento, con el fin de evitar que permanezcan residuos o gotas en el pavimento que pudieran dañar las baldosas. Deberá dejarse actuar el producto sobre el pavimento mojado, sin que se seque y frotándolo con trapos incoloros; luego se aclarará con agua abundante para asegurarse de que el pavimento quede libre de residuos de detergentes. La operación podrá repetirse si es necesario.

Se recomienda efectuar una limpieza previa sobre una superficie de muestra de algunos metros cuadrados; si el resultado es positivo, podrá limpiarse toda la superficie.

Una vez efectuada la limpieza mencionada arriba, habrá que realizar una limpieza básica o alcalina utilizando detergentes desengrasantes, ya que la limpieza ácida puede dejar untuosidades en el pavimento que podrían contribuir a retener la suciedad. Asimismo, y de manera específica, Mirage recomienda en los productos CP, WA, JW y OX 01 NAT prestar especial atención al uso de ácidos tamponados durante la fase de limpieza: estos materiales podrían sufrir daños superficiales en caso de que el ácido no fuera retirado en breve tiempo y en caso de que permanecieran accidentalmente huellas o gotas del compuesto agua/ácido utilizado para la limpieza después de la colocación. Todas las superficies LUC requieren el empleo de utensilios no abrasivos durante la fase de limpieza, para evitar opacificaciones y arañazos de la superficie.

▲ LIMPIEZA DIARIA

Una vez efectuada la limpieza “después de la colocación” (capítulo anterior), **se desaconseja vivamente para la limpieza diaria el uso de ceras, jabones oleosos, productos de impregnación y tratamientos varios (repelentes al agua y al aceite) sobre el producto de gres porcelánico**, dado que su aplicación no es necesaria. Algunos detergentes existentes en el mercado contienen a menudo ceras y aditivos abrillantadores que, tras varios lavados, pueden dejar en el pavimento patinas brillantes. A veces basta sólo una gota de bebidas como Coca Cola, agua, vino etc....para eliminar dicha patina, restableciendo el aspecto original de la baldosa y causando en algunas zonas el efecto mancha. En caso de ceras, habrá que desencerar el pavimento, en primer lugar, utilizando los productos desencerantes apropiados para las ceras aplicadas, siguiendo las instrucciones del fabricante. En caso de patinas creadas por jabón, cal y suciedad, habrá que utilizar, sin embargo, un detergente ácido diluido adecuadamente en agua (leer las instrucciones en la etiqueta del producto). Conviene señalar que el **ácido Fluorhídrico (HF)** y derivados pueden dañar el gres porcelánico de forma irremediable. **Para la limpieza ordinaria, Mirage aconseja el uso de lejía y amoníaco, diluidos adecuadamente en agua;** en caso de gres porcelánico con superficie pulida, se sugiere secar el pavimento para evitar que se vean cercos.

▲ LIMPIEZAS EXTRAORDINARIAS

En caso de manchas especiales y/o especialmente persistentes, se aconseja el uso de detergentes específicos, como se indica mejor en la tabla correspondiente de “Productos para la limpieza” propuesta en la pág. 570. Además, no hay que olvidar que la eliminación de cualquier tipo de mancha es más **fácil si se lleva a cabo cuando ésta todavía está fresca**. Es importante realizar siempre una prueba previa antes de usar productos detergentes, especialmente si se trata de gres porcelánico lapeado o pulido.

▲ SUELOS ELEVADOS

En caso de suelos elevados, no está permitido utilizar agua abundante; por lo tanto, se recomienda emplear un trapo bien escurrido. Las limpiezas ordinarias deberán efectuarse utilizando trapos apropiados, agua templada y detergente, limitando al máximo la cantidad de agua sobre el panel. En caso de manchas, podrán utilizarse productos concentrados directamente sobre ellas.

TECHNICAL DATA AND CERTIFICATIONS

ESPECIFICACIONES TÉCNICAS

DESCRIPCIÓN DEL MATERIAL

Gres porcelánico fino de calidad superior, homogéneo en todo su espesor
Fabricante:
MIRAGE® GRANITO CERAMICO® S.p.A., Pavullo (MO) – ITALIA

Se trata de losas de Granito Cerámico, de masa compacta, compuestas por arcillas nobles, cuarzos, feldespatos y óxidos metálicos calcinados (sin adhesivos, resinas o aditivos), prensadas a 450 kg/cm² y completamente sinterizadas a una temperatura de 1200 °C.

ACABADOS SUPERFICIALES

Los acabados superficiales pueden ser:

1) Boccia'drato
2) Silk
3) Grip
4) Naturale
5) Scalpellato
6) Radiale
7) Matte
8) Spazzolato
9) Strutturato
10) Lucido
11) Pearl

Los procesos de Lapeado y Pulido (10) se llevan a cabo mecánicamente con muelas de diamante y agua, sin otras sustancias químicas.

Tamaños Y TOLERANCIAS DIMENSIONALES

Los tamaños se subdividen por calibres y calidades según estándares cualitativos internos, que, en cualquier caso, son conformes y mejores que los expresados por la normativa EN 14411 - G.

Detallamos a continuación nuestros valores medios de tolerancia:
Longitud y anchura ± 0.3%
Espesor ± 5.0%
Rectitud de los lados ± 0.3%
Ortogonalidad ± 0.2%
Planitud ± 0.2%

DATOS TÉCNICOS (valores medios)

- Absorción de agua: < 0,1 %
- Resistencia a la flexión: 46-65 N/mm²
- Resistencia a la abrasión profunda: <147 mm³
- Resistencia a la helada de conformidad con la norma: EN ISO 10545-12
- Resistencia a los ataques químicos de conformidad con la norma: EN ISO 10545-13
- Carga de rotura (referida respectivamente a espesores de 9 mm – 10 mm – 20 mm): 2000 N - 3000 N - 13000 N

Los antedichos datos técnicos se refieren a la primera calidad y cumplen la normativa EN 14411 (certificados disponibles bajo petición).

Los posibles materiales presentados como alternativa al Granito Cerámico Mirage no deberán fabricarse con metodologías sustitutivas, ni poseer características técnicas inferiores.

Oferta solicitada a la empresa de colocación

Entrega y colocación con adhesivo, anchura de la junta de 2/3/4 mm según el formato.

Producto: GRES PORCELÁNICO FINO homogéneo en todo su espesor
Color: _____
Art.-N°: _____
Formato: _____
Acabado: _____
Cantidad: _____
Precio unitario: _____
Precio total:_____

[RU]

CARATTERISTICHE TECNICHE

Technical specifications | Technische Eigenschaften | Caractéristiques techniques | Características técnicas | Технические характеристики | 技术特征

ТЕХНИЧЕСКИЕ ХАРАКТЕРИСТИКИ													
													
ВОДОПОГЛОЩЕНИЕ ISO 10545-3													
Mirage выпускает материалы с минимальным коэффициентом поглощения за счет высочайших стандартов производства и качества, обеспечивающих компактность и низкую степень пористости продукции. Приведенные в технических таблицах параметры обозначают процент поглощения изделиями воды относительно их массы.	КОСЛЬЗКОСТЬ												
	1_DIN 51130												
Во время испытаний человек становится на горизонтальную поверхность, покрытую керамической плиткой и испачканную маслом. Поверхность наклоняется до тех пор, пока человек в специальной обуви не начинает скользить. Классификация плитки определяется углом наклона облицованной поверхности в момент скольжения.													
	<table> <tbody><tr> <td>a <6°</td> <td>не классифицируется</td></tr> <tr> <td>6°≤ a ≤10°</td> <td>R9</td></tr> <tr> <td>10°≤ a ≤19°</td> <td>R10</td></tr> <tr> <td>19°≤ a ≤27°</td> <td>R11</td></tr> <tr> <td>27°≤ a ≤35°</td> <td>R12</td></tr> <tr> <td>a >35°</td> <td>R13</td></tr> </tbody></table>	a <6°	не классифицируется	6°≤ a ≤10°	R9	10°≤ a ≤19°	R10	19°≤ a ≤27°	R11	27°≤ a ≤35°	R12	a >35°	R13
a <6°	не классифицируется												
6°≤ a ≤10°	R9												
10°≤ a ≤19°	R10												
19°≤ a ≤27°	R11												
27°≤ a ≤35°	R12												
a >35°	R13												
	2_DIN 51097												
Данным методом определяется соответствие керамической плитки для укладки в помещениях, где будут ходить босиком. Уложенная на горизонтальную поверхность плитка смачивается специальным раствором (1 г/л увлажняющего агента + вода). Поверхность наклоняется до тех пор, пока идущий по ней босиком человек не начинает скользить; в соответствии с углами наклона выстраивается указанная классификация.													
	<table> <tbody><tr> <td>a <12°</td> <td>не классифицируется</td></tr> <tr> <td>12°≤ a ≤18°</td> <td>A</td></tr> <tr> <td>18°≤ a ≤24°</td> <td>B (A+B)</td></tr> <tr> <td>a ≤24°</td> <td>C (A+B+C)</td></tr> </tbody></table>	a <12°	не классифицируется	12°≤ a ≤18°	A	18°≤ a ≤24°	B (A+B)	a ≤24°	C (A+B+C)				
a <12°	не классифицируется												
12°≤ a ≤18°	A												
18°≤ a ≤24°	B (A+B)												
a ≤24°	C (A+B+C)												
	УСТОЙЧИВОСТЬ К ИСТИРАНИЮ ISO 10545-6												
Испытание проводится на неглазурованной поверхности плитки (UGL) в целях определения количества материала, истираемого под воздействием вращающегося абразивного диска (150 об/мин). Чем прочнее керамическое изделие, тем меньше объем удаленного диском материала.													
													
МОРОЗОСТОЙКОСТЬ ISO 10545-12	УСТОЙЧИВОСТЬ К ОБРАЗОВАНИЮ ПЯТЕН ISO 10545-14												
Изделия для наружной укладки подвергаются износу в результате заморозков, так как в случае поглощения плиткой воды она замерзает, и плитка растрескивается. На изделия Mirage морозы не оказывают никакого воздействия, поскольку они отличаются компактностью и низкой пористостью.	Три разных вещества (растительное масло, йодный раствор и зеленый/хром) наносятся на плитку и остаются на ее поверхности в течение 24 часов, после чего составы удаляются.												
	КЛАСС 5												
	Пятно смывается проточной горячей водой в течение 5 минут.												
	КЛАСС 4												
	Пятно смывается слабым нейтральным моющим средством и не царапающей губкой.												
	КЛАСС 3												
	Пятно смывается основным моющим средством с абразивными элементами и вращающейся щеткой с жесткой щетиной.												
	КЛАСС 2												
	Пятно смывается специальным растворителем, воздействующим на пятно в течение 24 часов.												
	КЛАСС 1												
	Пятно не смывается.												
Неглазурованные изделия (UGL):													
A, LA, HA: B, LB, HB:	отсутствие видимого воздействия видимое воздействие на обрезанных кромках												
C, LC, HC:	видимое воздействие на обрезанных и не обрезанных кромках и на рабочей поверхности												
Глазурованные изделия (GL):													
A, LA, HA: B, LB, HB: C, LC, HC:	отсутствие видимого воздействия изменение внешнего вида поверхности частичная или полная потеря изначальной поверхности												

ХАРАКТЕРИСТИКИ КЕРАМИЧЕСКОГО ГРАНИТА

Керамогранит Mirage является совершенно натуральным материалом.

Регулируемое человеком “случайное” смещение натурального сырья разных цветов предупреждает повторяемость дизайна поверхности, присущую искусственным изделиям; в результате каждая плита уникальна по рисунку прожилок и сочетанию оттенков, но без избытка, что часто отличает натуральные камни.

- Базовые форматы плитки и специальные изделия могут поставляться других цветов. Небольшие расхождения по размеру допускаются по закону.
- Легкие точки на поверхности материала подчеркивают его естественность.
- Продукция не первого сорта и изделия, снятые с производства, продаются по принципу “проверены и приняты”, по ним рекламации не принимаются.
- Для наилучшего эстетического результата плитки с коэффициентом цветовой градации ≥ V2 рекомендуется укладывать ее из нескольких коробок одновременно, чтобы смещение оттенков было оптимальным.

ДОКУМЕНТАЦИЯ

Компания Mirage Granito ceramico SpA оставляет за собой право вносить изменения в приведенные в каталоге изделия в силу производственных потребностей или в целях повышения качества продукции.

Образцы служат только в качестве примера продукции. Тип и вес упаковки может быть изменен применительно к нуждам производства. В момент заказа обращайтесь в коммерческий отдел компании.

ИНСТРУКЦИИ ПО ЭКСПЛУАТАЦИИ И УХОДУ

РЕКОМЕНДАЦИИ ПО ПРАВИЛЬНОЙ УКЛАДКЕ И ЧИСТКЕ

▲ УКЛАДКА

По получении материала и до его укладки обязательно тщательно проверьте плитку по сортности, размерам и оттенкам, т.к. по уложенному материалу с заметными еще до укладки дефектами рекламации не принимаются. Для наилучшего эстетического результата плитки с коэффициентом цветовой градации ≥ V2 рекомендуется в процессе укладки брать ее из нескольких коробок одновременно, чтобы добиться оптимального смещения оттенков. Плитка с прожилками, как и натуральные камни, должна укладываться так, чтобы вид и цвет прожилок максимально украсшали керамическую поверхность. Укладка материала может выполняться как на цементный раствор, так и на клей при использовании специальных высокоэффективных клеевых составов для керамического гранита. Укладка на клей лучше, поскольку она гарантирует наибольшую герметичность материала, особенно крупноформатных плит (больше 45 x 45).

В момент укладки основание должно быть прочным, сухим, твердым, не заледеневшим и не слишком теплым; рекомендуется придерживаться инструкций изготовителей клея и материалов для подготовки основания. Клеевые составы на цементной основе выкладываются при комнатной температуре от +5° С до + 30/35° С.

При этом необходимо также соблюдать соответствующие параметры времени, указанные изготовителями плиточного клея.

Наиболее пригодные для укладки керамогранита компании Mirage клеевые составы определяются на основании действующих европейских стандартов EN12004.

Во время укладки на поверхности материала, особенно на полированной плитке, не рекомендуется делать отметки карандашом (графит) или несмываемым фломастером. Несмотря на то, что изделия Mirage отличаются высокой прочностью, можно менять их профиль (для создания верхних поверхностей, лестниц и проч.) и делать в них отверстия для установки сантехнического оборудования с помощью специальных алмазных дисков и инструмента для работы с керамогранитом.

▲ ШВЫ И ЗАМАЗКИ

Ширина шва зависит от размеров плитки и назначения пола. Бесшовная укладка не рекомендуется; предпочтение следует отдавать укладке с минимальным швом 2-3 мм (такой тип укладки обеспечивает наилучший прихват герметика на боковинах плит, более эффективное поглощение колебаний подстилающего слоя и компенсацию плит). В помещениях большой площади совершенно необходимо на равных участках создавать температурные швы, а в маленьких помещениях достаточно оставлять небольшой зазор между выложенной плиткой поверхностью и периметральными стенами. Такой зазор покрывается затем плитусом, придавая помещению завершенный вид. Всегда придерживайтесь советов и рекомендаций проектировщика или прораба.

Перед использованием эпоксидных замазок с добавлением полимеров или других составов рекомендуется предварительно попробовать их на возможность очистки. Для получения более красивого эстетического результата замазки должны подбираться в тон к плитке, чтобы уменьшить контраст между двумя материалами (например, белая плитка и черная замазка), особенно при укладке частично и полностью полированной плитки. Сразу после замазывания швов между плитками из керамического гранита необходимо аккуратно удалить избыток еще свежей замазки губкой с большим количеством воды. Через несколько дней после укладки произведите тщательную очистку поверхности кислотным раствором (см. Указания после укладки), чтобы растворить и полностью удалить все загрязнения. Можно использовать следующие составы:

- DETERDEK FILA INDUSTRIA CHIMICA - www.filachim.com
- DELTA PLUS KERAKOLL - www.kerakoll.com
- KERANET MAPEI - www.mapei.it
- SERVICE SOLVACID GEAL - www.geal-chim.it
- DISYCOTT FABER - www.faberchimica.com
- BONACLEAN BONASYSTEM - www.bonasytemsitalia.it
- STONETECH® CLEANER ACID - LATICRETE - www.laticrete.com

TECHNICAL DATA AND CERTIFICATIONS

ТЕХНИЧЕСКИЕ ХАРАКТЕРИСТИКИ

ОПИСАНИЕ МАТЕРИАЛА

Однородный по всей толщине керамический гранит высшего качества.
Производитель:
MIRAGE® GRANITO CERAMICO® SpA, Павулово (Модена) – ИТАЛИЯ

Компактные в массе плиты керамического гранита созданы с использованием благородных глин, кварцев, полевых шпатов и кальцинированных оксидов (без добавления клея, полимеров и присадок); плиты прессуются под давлением 450 кг/см² и полностью спекаются при температуре 1200°С.

ОТДЕЛКА ПОВЕРХНОСТИ

Разновидности поверхности отделки

1) Bocciardato
2) Silk
3) Grip
4) Naturale
5) Scalpellato
6) Radiale
7) Matte
8) Spazzolato
9) Strutturato
10) Lucido
11) Pearl

Процессы частичной и полной полировки (10) выполняются механически алмазными шлифовальными кругами с водой без добавления химических компонентов.

ФОРМАТЫ И РАЗМЕРНЫЕ ДОПУСКИ

Форматы разделены на размерные группы и выбраны согласно стандартам качества предприятия, соответствующим и превышающим нормативные требования EN 14411 - G.

Средние допустимые значения производимой компанией плитки:	
Длина и ширина	± 0.3%
Толщина	± 5.0%
Прямолинейность углов	± 0.3%
Ортогональность	± 0.2%
Плоскостность	± 0.2%

ТЕХНИЧЕСКИЕ ПАРАМЕТРЫ (средние значения)

- Водопоглощение: < 01 %
- Устойчивость на изгиб: 46-65 Н/мм²
- Устойчивость к глубокому истиранию: <147 мм²
- Морозоустойчивость по стандарту: EN ISO 10545-12
- Устойчивость к воздействию химреагентов по стандарту EN ISO 1 0545-1 3
- Устойчивость на излом (при толщине плитки 9 мм – 10 мм – 20 мм): 2000 Н - 3000 Н - 13000 Н.

Перечисленные технические параметры относятся к плитке первого сорта и соответствуют стандарту EN 14411 (по заказу предоставляются сертификаты).

Другие материалы, представляемые в качестве альтернативы к керамическому граниту Mirage, не должны быть изготовлены на базе низкокачественных технологий и не должны иметь более низкие технические характеристики.

Требования к компании, производящей укладку

Поставка и укладка на клей, ширина швов 2-3-4 мм в зависимости от формата.

Изделие: гомогенный по всей толщине МЕЛКОЗЕРНИСТЫЙ КЕРАМИЧЕСКИЙ ГРАНИТ

Цвет: _____

Арт. №: _____

Формат: _____

Поверхность: _____

Количество: _____

Штучная цена: _____

Общая цена: _____

[IT]

CONDIZIONI GENERALI DI VENDITA

General sale conditions | Allgemeine Liefer und Zahlungsbedingungen | Conditions generales de vente

Condiciones generales de venta | Условия продажи | 般销售条件

CONDIZIONI GENERALI DI VENDITA

Rev1a del 1 Gennaio 2018

A.- MODALITA' DI CONCLUSIONE DEL CONTRATTO

A.1.- Le presenti Condizioni Generali di Vendita disciplinano ogni contratto di Vendita tra il Venditore e l'Acquirente ed ogni loro modifica o deroga deve essere concordata per iscritto.

A.2.- Eventuali offerte, accrediti e/o abbuoni accordati da agenti o da altri intermediari, non sono ritenuti validi se non confermati per iscritto dal Venditore.

A.3.- L'Acquirente invia al Venditore, direttamente o per il tramite di agenti, Ordini scritti che devono contenere l'indicazione dei codici dei Prodotti richiesti, delle quantità, del loro prezzo e della destinazione. L'Ordine inviato dall'Acquirente è irrevocabile.

A.4.- La Vendita dovrà ritenersi conclusa nel momento in cui: (i) l'Acquirente riceva da parte del Venditore una Conferma scritta via e-mail, fax o altri mezzi telematici, conforme ai termini e alle condizioni dell'Ordine; o (ii) in caso di Conferma inviata dal Venditore contenente condizioni difformi dall'Ordine ricevuto dall'Acquirente quando questi l'accetti per iscritto o comunque non la contesti entro 7 (sette) giorni dalla ricezione; o (iii) in assenza di conferma scritta da parte del Venditore, nel momento in cui i Prodotti saranno consegnati e caricati dall'Acquirente.

B.- PREZZI

B.1.- Salvo diversa pattuizione scritta, i prezzi di vendita concordati di volta in volta si intendono al netto per contanti e per consegna franco stabilimento del Venditore indicato nella Conferma d'Ordine.

C.- CARATTERISTICHE DEI PRODOTTI

C.1.- L'Acquirente dichiara di aver preso visione ed attenersi al contenuto della seguente documentazione pubblicata nel sito internet aziendale: 1) Istruzioni per Uso e Manutenzione e 2) Schede tecniche.

C.2. Data la intrinseca variabilità del prodotto ceramico, le caratteristiche dei campioni e/o modelli inviati in precedenza dal Venditore all'Acquirente sono da considerarsi indicativi e non vincolanti.

C.3. Salvo specifiche richieste da concordare prima della Conferma d'Ordine, il Venditore non garantisce che l'ordine del singolo articolo venga evaso tutto con un medesimo lotto di produzione.

D.- TERMINI DI CONSEGNA

D.1.- I termini di consegna sono da intendersi indicativi e la proroga di essi non può far maturare all'Acquirente alcun diritto a richiedere indennizzi, ogni eccezione rimossa.
D.2.- Se, trascorsi 10 (dieci) giorni dalla data di avviso di merce pronta, l'Acquirente non ritira il materiale, il Venditore si riserva di stabilire discrezionalmente un nuovo termine di consegna.

E.- RESA E SPEDIZIONE

E.1.- L'eventuale variazione della destinazione dei Prodotti, diversa da quella concordata in Conferma d'Ordine, deve essere comunicata dall'Acquirente per iscritto entro e non oltre il secondo giorno antecedente a quello previsto per il ritiro presso la sede del Venditore. Il Venditore si riserva la facoltà di non accettare la variazione della destinazione dei Prodotti. Nel caso si verifichi che la destinazione effettiva del Prodotto sia stata diversa da quella dichiarata dall'Acquirente, il Venditore si riserva la facoltà di sospendere l'esecuzione delle forniture in corso e/o risolvere i contratti in corso senza che l'Acquirente possa rivendicare risarcimenti diretti e/o indiretti di alcun tipo.

E.2.- Salvo patto contrario, la fornitura della merce si intende Franco Fabbrica (EXW ai sensi degli Incoterms 2010) e ciò anche quando sia convenuto che la spedizione o parte di essa venga curata dal Venditore su mandato dell'Acquirente. In ogni caso i rischi passano all'Acquirente al più tardi con la consegna al primo trasportatore.

E.3.- Ferma restando l'estraneità del Venditore rispetto al contratto di trasporto, il Venditore non potrà essere indicato come "shipper" nella polizza di carico. La comunicazione del peso lordo del container allo spedizioniere, non costituisce alcuna assunzione di responsabilità da parte del Venditore ai fini della Convenzione SOLAS (Safety Of Life At Sea). In nessun caso tale comunicazione potrà essere intesa come VGM (Verified Gross Mass).

E.4.- L'Acquirente s'impegna affinché il mezzo inviato presso i magazzini del Venditore sia idoneo al carico in relazione alla natura dei Prodotti. Nel caso il mezzo che si presenta comporti significative difficoltà per le operazioni di carico, il Venditore si riserva di addebitare una penale pari al 4% del valore dei prodotti a copertura dei maggiori costi logistici. Se

il mezzo convenuto non è assolutamente idoneo, il Venditore si riserva la facoltà di negare le operazioni di carico senza che nulla possa essere richiesto dall'Acquirente a titolo di risarcimento per ogni onere diretto e/o indiretto che ne possa derivarne.

E.5.- È compito dell'Acquirente incaricare il vettore di controllare i prodotti prima del carico; eventuali osservazioni in relazione all'integrità degli imballi e della rispondenza delle quantità caricate a quelle indicate sul documento di trasporto, devono essere sollevate dal vettore al momento del carico. Tali osservazioni devono essere riportate su tutte le copie dei documenti di trasporto, altrimenti i prodotti caricati s'intendono integri e completi. Ne deriva che il Venditore non si assume alcuna responsabilità in relazione a mancanze o danni dei prodotti non segnalati dal vettore.
E.6.- È altresì responsabilità dell'Acquirente incaricare il vettore di verificare le modalità e la stabilità del carico sul mezzo affinché durante il trasporto non si verifichino rotture e affinché siano rispettate tutte le disposizioni di sicurezza riguardanti la circolazione stradale.

F.- PAGAMENTI

F.1.- Qualsiasi obbligazione di pagamento deve essere adempiuta presso la sede legale del Venditore. Eventuali pagamenti ad agenti, rappresentanti o ausiliari di commercio non si intendono effettuati finché le relative somme non pervengano al Venditore.

F.2.- E' fatto divieto all'Acquirente di eseguire il proprio adempimento mediante pagamenti provenienti da paesi diversi dal proprio paese di residenza se trattasi di paesi che non garantiscono un adeguato scambio di informazioni con l'Italia. In caso di violazione di tale divieto, il Venditore ha facoltà di risolvere il contratto per giusta causa senza che l'Acquirente possa vantare il diritto di ottenere alcun risarcimento per l'eventuale danno subito.

F.3.- Eventuali spese di bollo ed incasso effetti e tratte sono a carico dell'Acquirente. In caso di inadempimento, anche solo parziale, dal giorno fissato per il pagamento decorreranno a favore del Venditore gli interessi moratori nella misura prevista dal d.lgs. 09/10/2002 n. 231.

F.4.- Salvo diversi accordi scritti, l'Acquirente si impegna a non compensare alcun credito, comunque insorto, nei confronti del Venditore.

G.- RECLAMI

G.1.- Al ricevimento dei Prodotti, l'Acquirente dovrà sottoporli ad accurato controllo attraverso un esame visivo effettuato conformemente alle indicazioni riportate al punto 7 delle norme UNI EN ISO 10545-2
G.2.- L'installazione e la posa dei Prodotti deve essere effettuata attenendosi scrupolosamente alle raccomandazioni inerenti le attività da svolgere prima e durante la posa in opera indicate nel documento 1) Istruzioni per l' Uso e Manutenzione pubblicato nel sito internet del Venditore e sulla confezione del prodotto e/o all'interno della stessa. Non sono considerati vizi del Prodotto quelli generati da un'errata installazione e dalla mancata/errata manutenzione (difformi dalle indicazioni fornite nel 1) Istruzioni per l' Uso e Manutenzione), da una non idonea destinazione d'uso e/o dalla normale usura nel tempo.
G.3.- Fatti salvi i limiti di accettabilità previsti dalla norma internazionale EN 14411 (ISO 13006), le Parti riconoscono come Vizi Palesi i difetti dei Prodotti riscontrabili già al momento del loro ricevimento tali da rendere il materiale inidoneo all'uso o da diminuirne in modo apprezzabile il valore. Rientrano in tale categoria i difetti come definiti nel documento 1) Manuale di Posa, Uso, Pulizia e Manutenzione pubblicato nel sito internet del Venditore. A titolo esemplificativo e non esaustivo si riconoscono come Vizi Palesi i difetti superficiali, i difetti di decorazione, di lappatura/levigatura, di calibro, di planarità, di ortogonalità-rettilineità, di spessore, le crepe, le sbecature, i fuori tono, i toni mescolati e i Prodotti che presentano problemi da taglio/ scaglie.

G.4.- Nel caso l'Acquirente rilevi Vizi Palesi dovrà fare reclamo al Venditore per iscritto, a pena di decadenza, entro 8 (otto) giorni dal ricevimento e tenere a disposizione del Venditore l'intera partita di materiale. Il reclamo dovrà riportare i dati di fatturazione e una precisa descrizione del vizio reclamato corredata, quando possibile, da immagini fotografiche. Qualora il reclamo dovesse risultare infondato, l'Acquirente si rende disponibile a risarcire il Venditore delle spese sostenute per l'eventuale sopralluogo (perizie, viaggi ecc.).
G.5.- I Vizi Occulti dovranno essere notificati al Venditore mediante lettera raccomandata A.R., a pena di decadenza dalla garanzia, entro 8 (otto) giorni dalla data della scoperta del difetto.
G.6.- L'azione dell'Acquirente diretta a fare valere la garanzia

per vizi si prescrive comunque nel termine di 12 (dodici) mesi decorrenti dalla consegna dei Prodotti.

H.- GARANZIA PER VIZI

H.1. La garanzia del Venditore si intende limitata ai soli Prodotti di prima scelta e non ai Prodotti di seconda o terza scelta o di partite d'occasione con prezzi o sconti particolari quando debitamente segnalati in nota nella Conferma dell'Ordine.

H.2. Il Venditore non garantisce l'idoneità dei Prodotti ad usi particolari, ma soltanto le caratteristiche tecniche pubblicate nel sito internet nel documento 2) Schede tecniche.

L'indicazione d'uso, anche quando presentata dal Venditore in cataloghi e manuali, è da ritenersi puramente indicativa. Sulla base delle caratteristiche tecniche riportate nelle 2) Schede Tecniche è sempre compito del progettista valutare l'idoneità del Prodotto alle condizioni specifiche di utilizzo in funzione delle sollecitazioni e delle variabili che si possono verificare nell'ambiente di destinazione alterandone le sue caratteristiche, a titolo d'esempio, all'intensità del traffico, alla qualità del traffico (calpestio in presenza di sabbia, di detriti...), alle eventuali condizioni climatiche avverse e a qualsiasi altra aleatorietà a cui può essere esposto il materiale.

H.3.- Nel caso risulti accertato che il Prodotto manifesti Vizi Palesi, come definiti al sub lett. G n.3, il Venditore provvederà alla sostituzione del Prodotto difettoso con altro avente caratteristiche pari o superiori o nel caso ciò non sia possibile ad una congrua riduzione del prezzo. In alternativa l'Acquirente avrà diritto, previa restituzione dei Prodotti viziati, al rimborso del prezzo pagato, maggiorato del costo del trasporto, con esclusione del risarcimento di ogni altro danno diretto e/o indiretto.

H.4. La garanzia del Venditore deve ritenersi esclusa nel caso in cui il Prodotto affetto da Vizi Palesi (in tutto o in parte) sia stato utilizzato e/o comunque trasformato dovendosi ritenere che in tal modo l'Acquirente (o il suo cliente) abbia espresso la volontà di accettarli nello stato in cui si trovano.

H.5 Nel caso risulti accertato che il Prodotto manifesti Vizi Occulti, la garanzia del Venditore è limitata alla sostituzione del materiale con altro avente caratteristiche pari o superiori e ove ciò non sia possibile al rimborso del prezzo pagato maggiorato del costo del trasporto. In ogni caso la garanzia del Venditore per ogni danno diretto e/o indiretto comunque originato dal prodotto difettoso, deve intendersi limitata ad una somma che non potrà superare il doppio del prezzo di vendita applicato dal Venditore in relazione alla sola parte della fornitura difettosa.

H.6.- Nel caso l'Acquirente rivenda il Prodotto a soggetti tutelati dal codice del consumo (d.l. n.206/2005) sarà responsabile delle condizioni praticate se difformi da quelle qui riportate e dovrà accertarsi che i diritti del consumatore siano esercitati nel rispetto dei rimedi e dei termini fissati da tale codice. Nel caso sussistano i presupposti, il diritto di regresso e/o comunque di rivalsa spettanti all'Acquirente verso il Venditore/produttore non potrà eccedere le esenzioni ed i limiti come fissati dal sub lett. G n.1 al sub lett. H n.5.

I. CLAUSOLE SOLVE ET REPETE E RISOLUTIVE

I.1.- Ai sensi dell'art. 1462 del Codice Civile, per nessun motivo, ivi compresi pretesi vizi o difetti del materiale, l'Acquirente potrà sospendere o ritardare il pagamento del materiale ritirato, salva naturalmente la facoltà di ripetere quando possa dimostrare di avere indebitamente pagato.
I.2.- Nel caso di mutamento delle condizioni patrimoniali dell'Acquirente o di mancato pagamento anche parziale di prodotti già forniti, il Venditore può sospendere l'esecuzione delle forniture in corso e/o risolvere i contratti in corso senza che l'Acquirente possa rivendicare risarcimenti diretti e/o indiretti di alcun tipo.

L.- PATTO DI RISERVATO DOMINIO

L.1.- Fino a quando l'Acquirente non avrà provveduto all'integrale pagamento del prezzo, i Prodotti oggetto della fornitura rimarranno di proprietà del Venditore.

L.2.- Durante il periodo suddetto, l'Acquirente assumerà gli obblighi e le responsabilità del custode, e non potrà alienare, dare in uso, lasciare sequestrare o pignorare tali Prodotti senza dichiarare la proprietà del Venditore e dare immediato avviso a mezzo raccomandata A.R.

M.- FORZA MAGGIORE

M.1.- Ciascuna parte potrà sospendere l'esecuzione dei suoi obblighi contrattuali quando tale esecuzione sia resa impossibile o oggettivamente troppo onerosa da un impedimento imprevedibile indipendente dalla sua volontà, quale ad esempio: sciopero, boicottaggio, serrata, incendio, guerra (dichiarata o non), guerra civile, sommosse

e rivoluzioni, requisizioni, embargo, interruzioni di energia, rotture straordinarie di macchinari, ritardi nella consegna di componenti o materie prime.

M.2.- La parte che desidera avvalersi della presente clausola dovrà comunicare immediatamente per iscritto all'altra parte il verificarsi e la cessazione delle circostanze di forza maggiore.

M.3.- Qualora la sospensione dovuta a forza maggiore duri più di 60 (sessanta) giorni, ciascuna parte avrà il diritto di risolvere il presente contratto, previo un preavviso di 10 (dieci) giorni, da comunicarsi alla controparte per iscritto.

N.- OBBLIGO DI RISERVATEZZA

N.1.- L'Acquirente è tenuto ad osservare la più assoluta riservatezza su tutte le notizie di carattere tecnico (quali, in via meramente esemplificativa, disegni, prospetti, documentazioni, formule e corrispondenza) e di carattere

[EN]

GENERAL SALES CONDITIONS

Rev1a of 1st January 2018

A.- CONTRACT COMPLETION

A.1.- These general sales conditions govern every sales contract between the Seller and the Buyer and any amendment or exception thereof shall be agreed in writing.
A.2.- Any offers, credits and/or rebates granted by agents or other intermediaries, shall not be considered valid if they are not confirmed in writing by the Seller.

A.3.- The Buyer shall send the written orders to the Seller, directly or through the agents, and the orders shall include the codes of the required products, quantity, price and destination. The order sent by the Buyer is irrevocable.

A.4.- The sale shall be deemed completed when: (i) the Buyer receives a written confirmation from the Seller, via e-mail, fax or other electronic means, that complies with the terms and conditions of the order; or (ii) if the confirmation sent by the Seller contains conditions that differ from the order sent by the Buyer, when the latter accepts it in writing or in any case does not object within 7 (seven) days from reception; or (iii) if the Seller does not provide a written confirmation, when the products are delivered and loaded by the Buyer.

B.- PRICES

B.1.- The prices agreed upon for each individual sale are net prices for cash delivery ex works (the Seller's plant shall be specified in the order confirmation), unless otherwise agreed in writing.

C.- PRODUCT CHARACTERISTICS

C.1.- The Buyer declares to have read and comply with the content of the following documentation published on the corporate website: 1) Use and maintenance instructions 2) Technical data sheets.
C.2. Given the intrinsic variability of the ceramic products, the characteristics of the samples, previously sent by the Seller to the Buyer, are purely illustrative and cannot be deemed binding.
C.3. Unless specifically requested and agreed before the order confirmation, the Seller does not guarantee that the entire quantity of an article on order shall be sent from one same production lot.

D.- DELIVERY TERMS

D.1.- The delivery terms are approximate and a delay does not give the Buyer any right to claim compensation, without any exception.

D.2.- If the Buyer does not collect the goods, after 10 (ten) days from the date of the "goods ready" notice, the Seller has the right – at its discretion – to establish a new delivery date.

E.- SHIPPING ARRANGEMENTS AND TERMS

E.1.- The Buyer must communicate any variation in the destination of the products, different from the one agreed in the order confirmation, in writing within, and no later than, the second day before the day foreseen for the collection at the Seller's premises. The Seller reserves the right not to accept the change of the product destination. If the actual destination of the product is different from the one stated by the Buyer, the Seller reserves the right to suspend the execution of the supplies underway and/or to terminate the contracts in force and the Buyer shall not have the right to claim direct and/or indirect compensation of any type.

commerciale (ivi comprese le condizioni contrattuali, i prezzi d'acquisto, le condizioni di pagamento ...) apprese in esecuzione del presente Contratto.

N.2.- L'obbligo di riservatezza viene assunto per tutta la durata del Contratto, nonché per il periodo successivo alla sua esecuzione.

N.3.- In ogni caso di inosservanza dell'obbligo di riservatezza, la parte inadempiente è tenuta e risarcire all'altra tutti i danni che ne dovessero derivare.

O.- MARCHI E SEGNI DISTINTIVI DEL VENDITORE

O.1.-L'utilizzo dei marchi, dei modelli ornamentali e delle opere d'ingegno in genere, in qualunque forma o modo di espressione (quali a titolo meramente esemplificativo, ma non esaustivo: immagini, foto, disegni, filmati, figure, strutture, etc.) costituenti proprietà intellettuale del Venditore, attraverso qualsiasi mezzo (quali a titolo meramente

P.- LINGUA DEL CONTRATTO, LEGGE APPLICABILE, GIURISDIZIONE E COMPETENZA

P.1.- Il Contratto e le presenti condizioni sono redatti in lingua Italiana, la quale prevarrà nel caso di divergenza con la traduzione in altre lingue.
P.2.- La definizione di qualsiasi controversia comunque relativa alle forniture è soggetta alla legge ed alla giurisdizione dello Stato Italiano e la competenza territoriale viene devoluta in via esclusiva al Tribunale di Modena nella cui circoscrizione il Venditore ha la sua sede legale.

E.2.- Unless otherwise agreed, the goods shall be delivered ex-works (EXW - Incoterms 2010) and this shall also be the case when the parties agree that the delivery, or part of it, shall be arranged by the Seller on the Buyer's behalf. In any case, the risks shall transfer to the Buyer upon delivery to the first carrier.
E.3.- Without prejudice to the Seller's extraneity in relation to the transport contract, the Seller shall not be indicated as "shipper" on the bill of lading. The communication of the gross weight of the container to the Forwarding agent does not represent in any way the undertaking of any liability by the Seller as regards the SOLAS (Safety Of Life At Sea) Convention. In no event may the said communication be taken to be the VGM (Verified Gross Mass).

E.4.- The Buyer undertakes to ensure that the vehicle sent to the Seller's warehouse is suitable for the loading operations, considering the nature of the products. If the vehicle sent to collect the goods causes difficulties in the loading operations, the Seller reserves the right to charge a penalty, of 4% of the value of the products, to cover the extra logistics costs. If the vehicle sent is not at all suitable, the Seller reserves the right to refuse to load the goods and the Buyer shall not have the right to claim compensation for any direct and/or indirect cost that may arise therefrom.

E.5.- The Buyer is responsible for assigning the carrier the task of checking the products before loading them; any observations concerning the condition of the packaging and the correspondence of the quantities loaded with those

on the transport document must be made by the carrier upon collection of the goods. The said observations must be written on all the copies of the transport documents, otherwise the loaded products shall be considered to be complete and in good condition. As a result, the Seller shall not be liable for any missing or damaged products not reported by the carrier.

E.6.- The Buyer is also responsible for assigning the carrier the task of checking the loading procedure and the stability of the goods on the vehicle, in order to prevent damage during transport and to comply with all road safety provisions.

F.- PAYMENTS

F.1.- All payments must be made to the Seller's registered office. Payments made to agents, representatives, or sales assistants shall not be considered as made until the amounts are received by the Seller.

F.2.- The Buyer shall not fulfil its payment obligations by making payments from countries other than its own country of residence, if the said countries do not guarantee an adequate exchange of information with Italy. In case of breach of the said prohibition, the Seller has the right to terminate the contract for just cause and the Buyer shall not have the right to claim compensation for any damage suffered.

F.3.- Any costs for stamp duty and bank draft fees shall be borne by the Buyer. Failure to fulfil, even only in part, the payment shall result in the application of interest on arrears in favour of the Seller, from the date established for the payment, as envisaged by legislative decree 09/10/2002 no. 231.

F.4.- Unless otherwise agreed in writing, the Buyer undertakes not to offset any receivables, of whatever nature, owed by the Seller.

G.- CLAIMS

G.1.- Upon receipt of the products, the Buyer shall perform a

esemplificativo, ma non esaustivo: stampa, video, radio, internet, social media, piattaforme di messaggistica istantanea o VoIP, etc.) è severamente vietato. Qualsiasi deroga a tale divieto, anche solamente parziale, dovrà essere autorizzata per iscritto, caso per caso, dalla Direzione generale del Venditore.

P.- LINGUA DEL CONTRATTO, LEGGE APPLICABILE, GIURISDIZIONE E COMPETENZA

P.1.- Il Contratto e le presenti condizioni sono redatti in lingua Italiana, la quale prevarrà nel caso di divergenza con la traduzione in altre lingue.

P.2.- La definizione di qualsiasi controversia comunque relativa alle forniture è soggetta alla legge ed alla giurisdizione dello Stato Italiano e la competenza territoriale viene devoluta in via esclusiva al Tribunale di Modena nella cui circoscrizione il Venditore ha la sua sede legale.

P.- LINGUA DEL CONTRATTO, LEGGE APPLICABILE, GIURISDIZIONE E COMPETENZA

P.1.- Il Contratto e le presenti condizioni sono redatti in lingua Italiana, la quale prevarrà nel caso di divergenza con la traduzione in altre lingue.

P.2.- La definizione di qualsiasi controversia comunque relativa alle forniture è soggetta alla legge ed alla giurisdizione dello Stato Italiano e la competenza territoriale viene devoluta in via esclusiva al Tribunale di Modena nella cui circoscrizione il Venditore ha la sua sede legale.

visual inspection in compliance with instructions provided in point 7 of UNI EN ISO 10545-2 standards.
G.2.- The products must be installed and fitted strictly respecting the recommendations related to the activities to be performed before and during the laying of the product specified in document 1) Use and maintenance instructions, published on the Seller's website, and on the product packaging and/or inside the packaging. Faults caused by an incorrect installation and by missing/incorrect maintenance (different from instructions provided in document 1) Use and maintenance instructions), by an unsuitable use and/or by normal wear over time shall not be considered product faults.
G.3.- With the exception of the limits of acceptability foreseen by the international EN 14411 (ISO 13006) standard, the parties acknowledge as identifiable faults those product defects that are immediately visible upon receipt thereof and that make the material unsuitable for use or that significantly reduce its value. This category includes faults as defined in the document 1) Laying, use, cleaning and maintenance manual, published on the Seller's website. Identifiable faults include, by way of a non-limiting example, superficial defects, decoration defects, defects concerning polishing, dimensions, surface flatness, straightness of sides/ rectangularity and thickness, cracks, chippings or rough edges, non-compliant shades, mixed shades and products that feature problems deriving from the cutting process and/ or from chips.

G.4.- If the Buyer finds an identifiable fault, it must be reported in writing to the Seller, within 8 (eight) days from receipt of the products; failure to send the claim shall result in the forfeiture and loss of such right. The Buyer shall keep the entire lot of material readily available for the Seller. The claim shall include the invoice details and an accurate description of the claimed fault together with photographs, where possible. In the event that the claim proves to be unfounded, the Buyer shall refund the Seller any costs incurred for an inspection (expert's reports, travel, etc.).

G.5.- Hidden faults shall be notified to the Supplier in writing, by recorded delivery letter with advice of receipt, within 8 days from the date such fault is found, under penalty of forfeiture.

G.6.- The Buyer's right to make a claim for faults under warranty is valid for 12 (twelve) months from the delivery of the products.

H.- WARRANTY FOR FAULTS

H.1. The Seller's warranty is limited to first grade products and not second or third grade products or lots on offer with special prices or discounts, which must be duly specified with a note in the order confirmation.

H.2. The Seller does not guarantee the suitability of the products for particular uses, and only guarantees the technical specifications published on the website in the document 2) Technical data sheets. The indication for use is merely indicative, even when written in the Seller's catalogues and manuals. On the basis of the characteristics described in the document 2) Technical data sheets, the designer always has the task of assessing the suitability of the product for the specific use conditions, taking into account the stress and variables to which the product will be subjected, which may alter its characteristics; for example, the traffic intensity, quality of traffic (foot traffic with the presence of sand, debris...), adverse weather conditions and any other unpredictable factor to which the material may be exposed.

CONDIZIONI GENERALI DI VENDITA

General sale conditions | Allgemeine Liefer und Zahlungsbedingungen | Conditions generales de vente

Condiciones generales de venta | Условия продажи | 般销售条件

H.3.- In the event that identifiable product faults are

H.3.- In the event that identifiable product faults are ascertained, as defined in sub section G no. 3, the Seller shall replace the faulty product with another one with equal or superior characteristics; should this not be possible, the Seller shall apply a significant price reduction. Alternatively, following the return of the faulty products, the Buyer shall have the right to a refund of the price paid plus the transport cost, with the exclusion of compensation for any other direct and/or indirect damage.

H.4. The Seller’s warranty shall not be valid if the products that have identifiable faults (totally or in part) have been used and/or in any case transformed, as this entails that the Buyer (or its customer) expressed the intention to accept them in the condition in which they were found.

H.5.- In the event that hidden product faults are ascertained, the Seller’s warranty is limited to the replacement with other products of equal or superior characteristics; should this not be possible the Seller shall refund the price paid plus the transport cost. In any case, the Seller’s warranty for any direct and/or indirect damage caused by the faulty product, shall be limited to an amount that shall not be greater than double the selling price applied by the Seller, only in relation to the faulty part of the supply.

H.6.- In the event that the Buyer resells the product to subjects protected by the consumer code (law decree no. 206/2005), the former shall be responsible for the conditions applied, if different from those stated herein, and shall ensure that the consumer’s rights are exercised, in relation to the remedies and terms established by the said code. If there are the grounds for the Buyer to exercise the right of recourse and/or make a claim against the Seller/ manufacturer, the said action shall take into account or go beyond the exemptions and limits established in sub sections G no. 1 and H no. 5.

I. SOLVE ET REPETE (pay and then claim) AND TERMINATION CLAUSES
I.1.- Pursuant to article 1462 of the Italian Civil Code, on

[DE]

ALLGEMEINE VERKAUFSBEDINGUNGEN

ALLGEMEINE VERKAUFSBEDINGUNGEN

Fassung 1a vom 1. Januar 2018

A.- MODALITÄT DES VERTRAGSABSCHLUSSES

A1.- Die vorliegenden Allgemeinen Verkaufsbedingungen regeln alle Verträge zwischen dem Verkäufer und dem Käufer und alle Änderungen oder Abweichungen davon müssen schriftlich vereinbart werden.

A.2.- Eventuelle Angebote sowie mit Handelsvertretern oder sonstigen Vermittlern vereinbarten Gutschriften sind nicht verbindlich, es sei denn, sie werden vom Verkäufer schriftlich bestätigt.

A.3.- Der Käufer sendet dem Verkäufer direkt oder über Handelsvertreter schriftliche Bestellungen zu, die die Angabe der Artikelnummern der gewünschten Produkte, der Mengen, ihres Preises und der Bestimmung enthalten müssen. Die vom Käufer gesendete Bestellung ist unwiderrüflich.

A.4.- Der Verkauf gilt zu dem Zeitpunkt als abgeschlossen, an dem: (i) der Käufer vom Verkäufer eine schriftliche Bestätigung per E-Mail, Fax oder auf sonstigem Weg erhält, die den Fristen und Bedingungen der Bestellung entspricht; oder (ii) falls die vom Verkäufer gesendete Bestätigung, Bedingungen enthält, die von der vom Käufer erhaltenen Bestellung abweichen, wenn dieser diese akzeptiert oder nicht innerhalb von 7 (sieben) Tagen ab ihrem Empfang beanstandet; oder (iii) falls keine schriftliche Bestätigung durch den Verkäufer erfolgt, zu dem Zeitpunkt, an dem die Produkte geliefert und vom Käufer übernommen werden.

B.- PREISE

B1.- Vorbehaltlich abweichender schriftlicher Vereinbarungen gelten die von Mal zu Mal vereinbarten Verkaufspreise als Nettobarpreise bar mit Lieferung frei ab dem in der Auftragsbestätigung angegebenen Werk des Verkäufers.

C.- EIGENSCHAFTEN DER PRODUKTE

C1.- Der Käufer erklärt, die folgende auf der Web-Site des Unternehmens veröffentlichte Dokumentation zur Kenntnis genommen zu haben und sich an deren Inhalt zu halten: 1) Gebrauchsanleitungen und Pflege 2) Technische Datenblätter. C2. Aufgrund der intrinsischen Variabilität des Keramikprodukts sind die Eigenschaften der vorausgehend vom Verkäufer an den Käufer gesendeten Warenmuster und/oder Modelle hinweisend und unverbindlich.

C.3. Vorbehaltlich spezifischer Vereinbarungen vor der Auftragsbestätigung garantiert der Verkäufer nicht, dass die

no account may the Buyer suspend or delay payment of collected material, including in the event of alleged defects or faults in the material; this does not affect the right to claim back any payments made unduly (solve et repete). I.2.- If the Buyer’s financial situation changes or in the event of non-payment (even partial) of products already supplied, the Seller reserves the right to suspend the execution of the supplies underway and/or to terminate the contracts in force and the Buyer shall not have the right to claim direct and/or indirect compensation of any type.

L.- RETENTION OF OWNERSHIP

L.1.- The products supplied shall remain exclusive property of the Seller until the Buyer has paid the full amount.

L.2.- During the aforementioned period, the Buyer shall undertake the obligations and responsibilities as bailee (also referred to as custodian) and shall not transfer the said products, grant their use, let them be seized or distrained without declaring that the property is of the Seller, and the Buyer shall immediately inform the Seller by recorded delivery letter with advice of receipt.

M.- FORCE MAJEURE

M.1.- Each party may suspend the fulfilment of its contractual obligations, when the said fulfilment is impossible or objectively too costly due to an unforeseeable impediment independent from the parties, such as for example: strike, boycott, lockout, fire, war (declared or not), civil war, riots and revolutions, requisitions, embargo, power blackouts, extraordinary breakage of machinery, delays in the delivery of components or raw materials.

M.2.- The party that wishes to apply this clause shall immediately notify the onset and end of the circumstances of force majeure to the other party in writing.

M.3.- If the suspension due to force majeure lasts longer than 60 (sixty) days, each party shall have the right to terminate this contract, with a notice of 10 (ten) days to be notified to the counterparty in writing.

Lieferung des einzelnen Artikels vollständig mit dem gleichen

Produktionslos ausgeführt wird.

Vergütung der Schäden geltend machen kann, die direkt und/oder

indirekt daraus entstehen können.

E.5.- Es ist Aufgabe des Käufers, das Transportunternehmen zu

beauftragen und die Produkte vor dem Laden zu kontrollieren;

eventuelle Anmerkungen zur Unversehrtheit der Verpackungen

und der Übereinstimmung der geladenen Menge mit der in den

Transportpapieren angegebenen müssen vom

Transportunternehmen zum Zeitpunkt des Ladens vorgenommen

werden. Diese Anmerkungen müssen auf alle Exemplaren der

Transportpapiere vermerkt werden, anderenfalls gelten die

geladenen Produkte als unbeschädigt und vollständig. Daraus

folgt, dass der Verkäufer keinerlei Haftung für Fehlmengen

oder Beschädigungen der Produkte übernimmt, die vom

Transportunternehmen nicht gemeldet werden.

E.6.- Es ist ebenfalls Aufgabe des Käufers, das

Transportunternehmen zu beauftragen und die Modalität und

die Stabilität des Ladens auf das Fahrzeug zu überprüfen,

damit es während des Transports nicht zu Brüchen kommt,

sowie die Einhaltung der Sicherheitsbestimmungen der

Straßenverkehrsordnung zu gewährleisten.

N.- CONFIDENTIALITY

N.1.- The Buyer undertakes to maintain confidentiality as regards all information of a technical (such as, by way of a non-limiting example, drawings, tables, documentation, formulas and correspondence) and commercial nature (including contractual conditions, purchase prices, payment conditions,...) gained during the performance of this contract.

N.2.- The confidentiality obligation shall be undertaken for the entire duration of this contract and for the period following its execution.

N.3.- In case of failure to uphold the confidentiality obligation, the non-fulfilling party shall pay the other party compensation for all damages that may derive therefrom.

O.- SELLER’S TRADEMARKS AND DISTINCTIVE SIGNS

O.1.-The use of trademarks, ornamental designs and creative works in general, in whatever form and manner of expression (such as, by way of a non-limiting example: images, photos, drawings, videos, shapes, structures, etc.) constituting the Seller’s intellectual property, through any means (such as, by way of a non-limiting example: press, video, radio, internet, social media, instant messaging platforms or VoIP, etc.) is strictly forbidden. Any exception to the said prohibition, even only partial, must be authorised in writing, each time, by the Seller’s general management.

P.- CONTRACT LANGUAGE, APPLICABLE LAW, JURISDICTION AND AUTHORITY

P1.- The present CONTRACT is drafted in Italian, and in case of disputes the said version shall prevail over any translations in other languages.

P.2.- Any dispute concerning the supply of products shall be subject to Italian law and jurisdiction and the Court of Modena, the town in which the Seller has its registered office, shall have sole local jurisdiction.

Vergütung der Schäden geltend machen kann, die direkt und/oder

indirekt daraus entstehen können.

E.5.- Es ist Aufgabe des Käufers, das Transportunternehmen zu

beauftragen und die Produkte vor dem Laden zu kontrollieren;

eventuelle Anmerkungen zur Unversehrtheit der Verpackungen

und der Übereinstimmung der geladenen Menge mit der in den

Transportpapieren angegebenen müssen vom

Transportunternehmen zum Zeitpunkt des Ladens vorgenommen

werden. Diese Anmerkungen müssen auf alle Exemplaren der

Transportpapiere vermerkt werden, anderenfalls gelten die

geladenen Produkte als unbeschädigt und vollständig. Daraus

folgt, dass der Verkäufer keinerlei Haftung für Fehlmengen

oder Beschädigungen der Produkte übernimmt, die vom

Transportunternehmen nicht gemeldet werden.

E.6.- Es ist ebenfalls Aufgabe des Käufers, das

Transportunternehmen zu beauftragen und die Modalität und

die Stabilität des Ladens auf das Fahrzeug zu überprüfen,

damit es während des Transports nicht zu Brüchen kommt,

sowie die Einhaltung der Sicherheitsbestimmungen der

Straßenverkehrsordnung zu gewährleisten.

F.- ZAHLUNGEN

F1.- Alle Zahlungsverpflichtung müssen am Firmensitz des Verkäufers erfüllt werden. Eventuelle Zahlungen an Handelsvertreter oder Außendienstmitarbeiter gelten als nicht geleistet, bis sie beim Verkäufer eingehen.

F.2.- Es ist dem Käufer untersagt, die Zahlungen aus Ländern vorzunehmen, die vom Land seines Firmensitzes verschieden sind, falls diese Länder keinen angemessenen Informationsaustausch mit Italien gewährleisten. Im Fall der Verletzung dieses Verbots hat der Verkäufer das Recht, den Vertrag aus gutem Grund aufzulösen, ohne dass der Käufer eine Vergütung des entstandenen Schadens geltend machen kann.

F.3.- Eventuelle Kosten und Gebühren für die Einziehung von Effekten und Wechseln gehen zu Lasten des Käufers. Im Fall der Nichteinhaltung des für die Zahlung festgesetzten Tags - auch nur partiell - fallen Säumniszinsen zu Gunsten des Verkäufers an, in der vom ital. Gesetzlerlass vom 9. Oktober 2002, Nr. 231 vorgesehenen Höhe.

F.4.- Vorbehaltlich abweichender schriftlicher Vereinbarungen verpflichtet sich der Käufer, keine Guthaben gegenüber dem Verkäufer zu verrechnen.

G.- BEANSTANDUNGEN

G1.- Beim Empfang der Produkte muss der Käufer sie einer

sorgfältigen Sichtkontrolle gemäß den Angaben von Punkt 7 der Normen UNI EN ISO 10545-2 unterziehen.

G.2.- Die Installation und die Verlegung der Produkte müssen unter Einhaltung der Empfehlungen zu den Arbeiten ausgeführt werden, die vor und während der Verlegung ausgeführt werden müssen, wie angegeben im Dokument 1) Gebrauchsanleitungen und Pflege veröffentlicht auf der Web-Site des Verkäufers und angegeben auf der Verpackung des Produkts und/oder im Inneren derselben. Schäden, die durch eine falsche Installation, Verlegung und durch eine unterlassene/falsche Pflege (abweichend von den Angaben in 1) Gebrauchsanleitungen und Pflege), durch eine ungeeignete Gebrauchsbestimmung oder durch normale Abnutzung verursacht werden, werden nicht als Mängel des Produkts anerkannt.

G.3.- Vorbehaltlich der Grenzen der Akzeptabilität, die von der internationalen Norm EN 14411 (ISO 13006) vorgesehen sind, erkennen die Parteien Mängel der Produkte als offensichtliche Mängel an, die bereits bei ihrem Empfang festgestellt werden können, die das Material zur Verwendung ungeeignet machen oder die den Wert beträchtlich verringern. In diese Kategorie fallen Mängel, wie im Dokument definiert 1) Handbuch zur Verlegung, Benutzung, Reinigung und Pflege, veröffentlicht auf der Web-Site des Verkäufers. Als nicht erschöpfende Beispiele werden Oberflächenmängel, fehlerhafte Grafik, Defekte polierte Oberfläche, Defekte des Kalibers, der Planarität, der Rechtwinkligkeit/ Gradlinigkeit, der Stärke, Risse, abgeschlagene Kanten, Fehlfarbe, gemischte Brandfarbe sowie Produkte mit Kantsplittierung durch Rettifizierung als offensichtliche Mängel anerkannt.

G.4.- Falls der Käufer offensichtliche Mängel feststellt, muss er dies dem Verkäufer innerhalb von 8 (acht) Tagen ab dem Empfang schriftlich melden und die gesamte Charge des Materials für den Verkäufer zur Verfügung halten; anderenfalls verfällt der Rechtsanspruch. Bei der Beanstandung müssen die Daten der Rechnung sowie eine präzise Beschreibung des beanstandeten Mangels angegeben werden, falls möglich mit einer fotografischen Dokumentation. Falls die Beanstandung unberechtigtt sein sollte, ist der Käufer gehalten, dem Verkäufer die für einen eventuellen Ortstermin aufgewendeten Kosten (Gutachten, Reisekosten, usw.) zu erstatten.

G.5.- Versteckte Mängel müssen dem Verkäufer innerhalb von 8 (acht) Tagen ab Feststellung des Mangels per Einschreiben mit Rückschein gemeldet werden; anderenfalls verfällt der Rechtsanspruch.

G.6.- Die Aktion des Käufers zur Inanspruchnahme der Mängelhaftung muss in jedem Fall innerhalb von 12 (zwölf) Monaten ab der Lieferung der Produkte erfolgen.

H.- MÄNGELHAFTUNG

H.1. Die Garantie des Verkäufers ist begrenzt auf Produkte erster Qualität und sie bezieht sich nicht auf Produkte zweiter oder dritter Qualität oder auf gelegentliche Partien mit besonderen Preisen oder Nachlässe, die in der Auftragsbestätigung angegeben werden.

H.2. Der Verkäufer garantiert nicht die Eignung der Produkte für besondere Verwendungen, sondern lediglich die technischen Eigenschaften, die auf der Web-Site in Dokument 2) Technische Datenblätter veröffentlicht sind. Die Angabe zur Verwendung ist als unverbindlich anzusehen, auch wenn vom Verkäufer in Katalogen und Handbüchern angeben ist. Es ist stets Aufgabe des Planers, auf der Grundlage der in den 2) Technischen Datenblättern angegebenen Eigenschaften die Eignung des Produkts für spezifische Nutzungsbedingungen zu bewerten, unter Berücksichtigung der Belastungen sowie der Variablen, die am Ort der Bestimmung auftreten und die Eigenschaften verändern können,

[FR]

CONDITIONS GÉNÉRALES DE VENTE

Rév.1a du 1er Janvier 2018

A.- MODALITÉS DE CONCLUSION DU CONTRAT

A1.- Les présentes Conditions Générales de Vente régissent tout contrat de Vente entre le Vendeur et l’Acheteur et toute modification ou dérogation de ces dernières doit être convenue par écrit.

A.2.- D’éventuelles offres, accréditations et / ou ristournes accordées par des agents ou par d’autres intermédiaires, ne seront réputées valables que si elles sont confirmées par écrit par le Vendeur.

A.3.- L’Acheteur envoie au Vendeur, directement ou par l’intermédiaire d’agents, des Commandes écrites qui doivent indiquer les codes des Produits demandés, les quantités, leur prix et leur destination. La commande envoyée par l’Acheteur est irrévocable.

A.4.- La Vente doit être réputée conclue au moment où : (i) l’Acheteur reçoit de la part du Vendeur une Confirmation écrite par e-mail, par télécopie ou par d’autres moyens télématiques, conforme aux conditions de la Commande ; ou (ii) en cas de Confirmation envoyée par le Vendeur contenant des conditions

wie zum Beispiel die Intensität des Verkehrs, die Qualität des Verkehrs (Begehung bei Vorhandensein von Sand, Schmutz usw.), die eventuellen klimatischen Bedingungen sowie alle sonstigen Einflüsse, denen das Material ausgesetzt sein kann.

H.3.- Falls festgestellt wird, dass das Produkt offensichtliche Mängel aufweist, wie definiert in Punkt G, Nr. 3, nimmt der Verkäufer die Ersetzung des mangelhaften Produkts durch ein anderes mit gleichen oder höherwertigen Eigenschaften vor, oder er nimmt eine angemessene Reduzierung des Preises vor, falls dies nicht möglich ist. Alternativ hat der Käufer nach Rücklieferung der mangelhaften Produkte das Recht ar Rückerstattung des bezahlten Preises, zuzüglich der Transportkosten, mit Ausschließung der Vergütung aller direkten und/oder indirekten Schäden.

H.4. Die Garantie des Verkäufer wird ausgeschlossen, falls das mangelhafte Produkt (ganz oder teilweise) verwendet und/oder umgewandelt worden ist, da davon ausgegangen wird, dass der Käufer (oder sein Kunde) dadurch seinen Willen zum Ausdruck gebracht hat, es in dem Zustand zu akzeptieren, in dem es sich befindet.

H.5 Falls festgestellt wird, dass das Produkt versteckte Mängel aufweist, ist die Garantie des Verkäufers auf die Ersetzung des Materials durch anderes mit gleichen oder höherwertigeren Eigenschaften beschränkt oder - falls dies nicht möglich ist - auf die Rückerstattung des bezahlten Preises, zuzüglich der Transportkosten. In jedem Fall ist die Garantie des Verkäufers für alle direkten und/oder indirekten Schäden, die durch das mangelhafte Produkt entstehen, auf einen Betrag begrenzt, der das Doppelte des Verkaufspreises nicht übersteigen kann, den der Verkäufer auf den mangelhaften Teil der Lieferung angewendet hat. H.6.- Falls der Käufer das Produkt an Kunden weiterverkauft, die vom Verbraucherschutzgesetz (Ital. Gesetzlerlass Nr. 206/2005) geschützt werden, ist er verantwortlich für die angewendeten Bedingungen, falls diese von den hier angegebenen abweichen, und er muss sicherstellen, dass die Rechte des Verbrauchers gemäß den Bestimmungen dieses Gesetzes ausgeübt werden können. Falls die Voraussetzungen gegeben sind, kann das Regressrecht des Käufers gegenüber dem Verkäufer/Hersteller nicht die Grenzen übersteigen, die von Punkt G, Nr. 1 bis Punkt H, Nr. 5 angegeben werden.

I. KLAUSEL SOLVE ET REPETE UND AUFLÖSUNGSKLAUSEL

I.1.- Gemäß den Bestimmungen von § 1462 des ital. Bürgerlichen Gesetzbuches kann der Käufer in keinem Fall - einschließlich von vermeintlichen Mängeln oder Defekten des Materials - die Zahlung des abgenommenen Materials aussetzen oder verzögern, natürlich vorbehaltlich des Rechts, ungerechtfertigt gezahlte Beträge zurückzufordern, und dies nur nach Erbringung des Nachweises der Rechtmäßigkeit der Forderung (Solve et Repete).

I.2.- Im Fall der Veränderung der Vermögensbedingungen des Käufers oder der auch nur partiellen Nichtbezahlung der bereits gelieferten Produkte kann der Verkäufer die laufenden Lieferungen aussetzen und/oder die laufenden Verträge auflösen, ohne dass der Käufer die Vergütung von direkten und/oder indirekten Schäden geltend machen kann.

L.- EIGENTUMSVORBEHALT

L.1.- Bis zur vollständigen Bezahlung des Preises durch den Käufer bleiben die Produkte, die den Gegenstand der Lieferung darstellen, Eigentum des Verkäufers.

L.2.- Während dieses Zeitraums übernimmt der Käufer die Pflichten und die Verantwortlichkeiten für die Aufbewahrung der gekauften Produkte und er kann sie nicht veräußern, zur Nutzung überlassen oder beschlagnahmen oder pfänden lassen, ohne das Eigentum

la Confirmation de Commande, le

Vendeur ne garantit pas la

commande d’un article soit

intégralement constituée par un

même lot de production.

D.1.- Les délais de livraison

s’entendent fournis à titre

indicatif et leur prorogation ne

donne en aucun cas le droit à

l’Acheteur de demander des

indemnisations, excluant dès à

présent toute exception.

D.2.- Si l’Acheteur ne retire pas

le matériel, au bout d’un délai

de 10 (dix) jours à compter de

la date de l’annonce indiquant

que la marchandise est prête, le

Vendeur se réserve la faculté de

fixer à sa discrétion un nouveau

délai de livraison.

E.- LIVRAISON ET EXPÉDITION

E.1.- L’éventuelle variation de la destination des Produits, différente de celle convenue dans la Confirmation de Commande, doit être communiquée par l’Acheteur par écrit au plus tard le second jour qui précède le jour du retrait au siège du Vendeur. Le Vendeur se réserve la faculté de ne pas accepter la variation de la destination des Produits. Au cas où la destination effective du Produit serait différente de

des Verkäufers anzugeben und ohne diesen umgehend per Einschreiben mit Rückschein zu benachrichtigen.

M.- HÖHERE GEWALT

M.1.- Beide Parteien können die Ausführung der vertraglichen Pflichten aussetzen, wenn die Ausführung aus Gründen, die vom eigenen Willen unabhängig sind, unmöglich oder objektiv zu aufwendig wird, wie zum Beispiel: Streiks, Boykott, Aussperrung, Brand, Krieg (erklärt oder nicht), Bürgerkrieg, Aufstände und Revolutionen, Beschlagnahme, Embargo, Unterbrechungen der Energieversorgung, außerordentliche Defekte von Maschinen, Verspätung bei der Anlieferung von Komponenten und Rohstoffen.

M.2.- Die Partei, die beabsichtigt, die vorliegende Klausel in Anspruch zu nehmen, muss der anderen Partei schriftlich das Auftreten von Umständen der Höheren Gewalt mitteilen.

M.3.- Falls die Aussetzung aufgrund von Höherer Gewalt mehr als 60 (sechzig) Tage andauert, haben beiden Parteien das Recht, den vorliegenden Vertrag nach einer schriftlichen Vorankündigung von 10 (zehn) Tagen an die Gegenpartei aufzulösen.

N.- VERTRAULICHKEITSPFLICHT

N.1.- Der Käufer ist gehalten, über alle technischen Informationen (wie zum Beispiel Zeichnungen, Prospekte, Dokumentationen, Formeln und Schriftverkehr) und kommerziellen Informationen (einschließlich der Vertragsbedingungen, der Kaufpreise, der Zahlungsbedingungen usw.), in deren Kenntnis während der Ausführung des vorliegenden Vertrages kommt, absolute Vertraulichkeit einzuhalten.

N.2.- Die Vertraulichkeitspflicht wird für die Dauer des Vertrages sowie den Zeitraum nach seiner Ausführung übernommen.

N.3.- Im Fall der Nichteinhaltung der Vertraulichkeitspflicht ist die nicht einhaltende Partei gehalten, der anderen Partei alle daraus entstehenden Schäden zu vergüten.

O.- MARKEN UND KENNZEICHNUNGEN DES VERKÄUFERS

O.1.-Die Verwendung von Marken, Ziermotiven und geistigem Eigentum im Allgemeinen in jeder Form sowie jeder Ausdrucksform (als nicht erschöpfendes Beispiel: Bilder, Fotos, Zeichnungen, Filme, Abbildungen, Strukturen usw.), die intellektuelles Eigentum des Verkäufers sind, ist auf jede Weise (als nicht erschöpfendes Beispiel: Presse, Video, Radio, Internet, Social Media, Instant-Message-Plattform oder VoIP usw.) strengstens untersagt. Alle - auch nur partielle - Abweichungen von diesem Verbot müssen von Fall zu Fall schriftlich von der Generaldirektion des Verkäufers autorisiert werden.

P.- SPRACHE DES VERTRAGS, ANWENDBARES RECHT, RECHTSPRUCHUNG UND GERICHTSSTAND

P1.- Der Vertrag und die vorliegenden Bedingungen werden in italienischer Sprache verfasst, die im Fall der Abweichung der Übersetzung in andere Sprachen Vorrang hat.

P.2.- Die Regelung aller Rechtssachen hinsichtlich den Lieferungen unterliegt der Rechtsprechung des italienischen Staats und die territoriale Zuständigkeit liegt ausschließlich beim Bezirksgericht Modena, dem Ort des Firmensitzes des Verkäufers.

CONDIZIONI GENERALI DI VENDITA

General sale conditions | Allgemeine Liefer und Zahlungsbedingungen | Conditions generales de vente

Condiciones generales de venta | Условия продажи | 般销售条件

М.2.

guerra civil, rebelión y revolución, requisición, embargo, interrupción de energía, rotura extraordinaria de maquinaria, retraso en la entrega de componentes o materias primas.
M.2.- La parte que desee valerse de la presente cláusula deberá comunicar de inmediato por escrito a la otra parte el verificarse y el cese de las circunstancias de fuerza mayor.
M.3.- En caso de que la suspensión causada por fuerza mayor dure más de 60 (sesenta) días, cada una de las partes tendrá derechos de rescindir el presente contrato, con preaviso de 10 (diez) días, a comunicar a la otra parte por escrito.

N.- OBLIGACIÓN DE CONFIDENCIALIDAD

N1.- El Comprador debe mantener la más absoluta confidencialidad respecto de todas las informaciones de carácter técnico (tales como, solo como ejemplo, diseños, prospectos, documentaciones, fórmulas y correspondencia) y de carácter comercial (incluidas las condiciones contractuales, los precios de compra, las condiciones

M.2.

M.3.

M.4.

M.5.

M.6.

M.7.

M.8.

M.9.

M.10.

M.11.

M.12.

M.13.

M.14.

M.15.

M.16.

M.17.

M.18.

M.19.

M.20.

M.21.

M.22.

M.23.

M.24.

M.25.

M.26.

M.27.

M.28.

M.29.

M.30.

M.31.

M.32.

M.33.

M.34.

M.35.

M.36.

M.37.

M.38.

M.39.

M.40.

M.41.

M.42.

M.43.

M.44.

M.45.

M.46.

M.47.

M.48.

M.49.

M.50.

M.51.

M.52.

M.53.

M.54.

M.55.

M.56.

M.57.

M.58.

M.59.

M.60.

M.61.

M.62.

M.63.

M.64.

M.65.

M.66.

M.67.

M.68.

M.69.

M.70.

M.71.

M.72.

M.73.

M.74.

M.75.

M.76.

M.77.

M.78.

M.79.

M.80.

M.81.

M.82.

M.83.

M.84.

M.85.

M.86.

M.87.

M.88.

M.89.

M.90.

M.91.

M.92.

M.93.

M.94.

M.95.

M.96.

M.97.

M.98.

M.99.

M.100.

de pago, etc.) obtenidas a propósito de la ejecución del presente contrato.

N.2.- La obligación de confidencialidad es válida por toda la duración del contrato, así como por el periodo sucesivo a su ejecución.

N.3.- En cualquier caso de inobservancia de la obligación de confidencialidad, la parte incumplidora deberá indemnizar a la otra por todos los daños que de ello puedan derivar.

O.- MARCAS Y SIGNOS DISTINTIVOS DEL VENDEDOR

O.1.- Queda severamente prohibido el uso a través de cualquier medio (tales como, solo a título de ejemplos no exhaustivos: prensa, videos, radio, internet, social media, plataformas de mensajería instantánea o VoIP, etc.) de las marcas, de los modelos ornamentales y de las obras del ingenio en general que constituyan propiedad intelectual del Vendedor y ello en cualquier forma o modo de expresión (tales como, solo a título de

M.2.

M.3.

M.4.

M.5.

M.6.

M.7.

M.8.

M.9.

M.10.

M.11.

M.12.

M.13.

M.14.

M.15.

M.16.

M.17.

M.18.

M.19.

M.20.

M.21.

M.22.

M.23.

M.24.

M.25.

M.26.

M.27.

M.28.

M.29.

M.30.

M.31.

M.32.

M.33.

M.34.

M.35.

M.36.

M.37.

M.38.

M.39.

M.40.

M.41.

M.42.

M.43.

M.44.

M.45.

M.46.

M.47.

M.48.

M.49.

M.50.

M.51.

M.52.

M.53.

M.54.

M.55.

M.56.

M.57.

M.58.

M.59.

M.60.

M.61.

M.62.

M.63.

M.64.

M.65.

M.66.

M.67.

M.68.

M.69.

M.70.

M.71.

M.72.

M.73.

M.74.

M.75.

M.76.

M.77.

M.78.

M.79.

M.80.

M.81.

M.82.

M.83.

M.84.

M.85.

M.86.

M.87.

M.88.

M.89.

M.90.

M.91.

M.92.

M.93.

M.94.

M.95.

M.96.

M.97.

M.98.

M.99.

M.100.

ejemplos no exhaustivos: imágenes, fotos, dibujos, videos, figuras, estructuras, etc.).

Cualquier excepción a esta prohibición, incluso solo parcial, deberá ser autorizada caso por caso por escrito por la dirección general del Vendedor.

P.- IDIOMA DEL CONTRATO, LEY APLICABLE, JURISDICCIÓN Y COMPETENCIA

P.1.- El contrato y las presentes condiciones son redactados en lengua italiana, la cual prevalecerá en caso de divergencia con las traducciones en otros idiomas.

P.2.- La resolución de cualquier controversia de cualquier forma relativa al suministro queda sujeta a la ley y a la jurisdicción del Estado Italiano y la competencia territorial es asignada de forma exclusiva al Tribunal de Módena, en cuya circunscripción el Vendedor tiene su domicilio legal.

M.2.

M.3.

M.4.

M.5.

M.6.

M.7.

M.8.

M.9.

M.10.

M.11.

M.12.

M.13.

M.14.

M.15.

M.16.

M.17.

M.18.

M.19.

M.20.

M.21.

M.22.

M.23.

M.24.

M.25.

M.26.

M.27.

M.28.

M.29.

M.30.

M.31.

M.32.

M.33.

M.34.

M.35.

M.36.

M.37.

M.38.

M.39.

M.40.

M.41.

M.42.

M.43.

M.44.

M.45.

M.46.

M.47.

M.48.

M.49.

M.50.

M.51.

M.52.

M.53.

M.54.

M.55.

M.56.

M.57.

M.58.

M.59.

M.60.

M.61.

M.62.

M.63.

M.64.

M.65.

M.66.

M.67.

M.68.

M.69.

M.70.

M.71.

M.72.

M.73.

M.74.

M.75.

M.76.

M.77.

M.78.

M.79.

M.80.

M.81.

M.82.

M.83.

M.84.

M.85.

M.86.

M.87.

M.88.

M.89.

M.90.

M.91.

M.92.

M.93.

M.94.

M.95.

M.96.

M.97.

M.98.

M.99.

M.100.

defectos y en соответствии с положениями п. 3 раздела G, Продавец заменит дефектную Продукцию другой, обладающей такими же или более высокими характеристиками. Если это невозможно, то он надлежащим образом снизит цену. В качестве альтернативы после возврата дефектной Продукции Покупатель имеет право на возмещение уплаченной цены и транспортных расходов, при этом исключено возмещение любого другого прямого и/или косвенного ущерба.

H.4. Гарантия Продавца считается отмененной в случае, если Продукция, частично или полностью имеющая явные дефекты, была использована и/или трансформирована каким-либо образом, поскольку считается, что этими действиями Покупатель (или его клиент) выразил волю принять Продукцию в том состоянии, в котором она находится.

H.5 В случае установления того факта, что Продукция имеет скрытые дефекты, гарантия Продавца ограничена заменой материала другим, обладающим такими же или более высокими характеристиками. Если это невозможно, то Продавец возместит уплаченную цену и транспортные расходы. В любом случае, гарантия Продавца на любой прямой и/или косвенный ущерб, вызванный каким-либо образом дефектной Продукцией, ограничена суммой, которая не может превышать больше

TECHNICAL DATA AND CERTIFICATIONS

JL 01 LUC _ JL 02 LUC _ JL 03 LUC _ JL 04 LUC _ JW 01 LUC _ JW 02 LUC _ JW 12 LUC _ JW 14 LUC _ JW 15 LUC _ JW 19 LUC _ CP 01 LUC _ CP 02 LUC _ CP 03 LUC CP 04 LUC _ CP 05 LUC _ WA 01 LUC _ WA 08 LUC _ WA 09 LUC _ WA 10 LUC _ JW 03 LUC _ JW 17 LUC _ JW 11 LUC _ ESPOIR CHAUD LUC _ ESPOIR FROID LUC

[IT]	[EN]	[DE]	[FR]	[ES]	[RU]	[中文]
I prodotti JL 01 LUC, JL 02 LUC, JL 03 LUC, JL 04 LUC, JW 01 LUC, JW 02 LUC, JW 03 LUC, JW 11 LUC, JW 12 LUC, JW 14 LUC, JW 15 LUC, JW 17 LUC, JW 19 LUC, CP 01 LUC, CP 02 LUC, CP 03 LUC, CP 04 LUC, CP 05 LUC, WA 01 LUC, WA 08 LUC, WA 09 LUC, WA 10 LUC, ESPOIR CHAUD LUC, ESPOIR FROID LUC, come tutti i materiali Mirage, rispondono alla normativa UNI EN ISO 14411. Si fa presente che, le norme sopraccitate non prevedono la pulibilità da tracce di gomma (scarpe, tacchi,tappi di sedie, etc...) in particolare negli ambienti dove tali fenomeni sono maggiormente possibili e ripetitivi. In generale comunque la specifica lavorazione di Levigatura o Lappatura rende la superficie più lucida asportando una parte di materiale e quindi aprendo alcuni micro-pori in superficie, rendendo il prodotto più attaccabile alle macchie. Pertanto, su tali prodotti Mirage Granito Ceramico SpA declina ogni responsabilità.	JL 01 LUC, JL 02 LUC, JL 03 LUC, JL 04 LUC, JW 01 LUC, JW 02 LUC, JW 03 LUC, JW 11 LUC, JW 12 LUC, JW 14 LUC, JW 15 LUC, JW 17 LUC, JW 19 LUC, CP 01 LUC, CP 02 LUC, CP 03 LUC, CP 04 LUC, CP 05 LUC, WA 01 LUC, WA 08 LUC, WA 09 LUC, WA 10 LUC, ESPOIR CHAUD LUC, ESPOIR FROID LUC, like all Mirage materials, comply with standard UNI EN ISO 14411. The above standards do not include the possibility to clean traces of rubber (from shoes, heels, chair caps, etc...) particularly in areas where this is possible or repetitive. Generally, the specific Polishing or Lapping process makes the surface shinier and removes a part of the material, opening micro-pores in the surface and making the product more at risk of staining. Therefore Mirage Granito Ceramico SpA declines all liability for these products.	Die Produkte JL 01 LUC, JL 02 LUC, JL 03 LUC, JL 04 LUC, JW 01 LUC, JW 02 LUC, JW 03 LUC, JW 11 LUC, JW 12 LUC, JW 14 LUC, JW 15 LUC, JW 17 LUC, JW 19 LUC, CP 01 LUC, CP 02 LUC, CP 03 LUC, CP 04 LUC, CP 05 LUC, WA 01 LUC, WA 08 LUC, WA 09 LUC, WA 10 LUC, ESPOIR CHAUD LUC, ESPOIR FROID LUC, erfüllen wie alle Materialien von Mirage die Norm UNI EN ISO 14411. Bitte beachten Sie, dass die genannten Normen die Reinigungsfähigkeit von Gummispuren (Schuhe, Absätze Stuhlbeine etc. ...) nicht vorsehen, vor allem nicht in Bereichen, in denen solche Phänomene wahrscheinlich und häufig auftreten. Im Allgemeinen aber verleiht das Lappen oder Schleifen der Oberfläche mehr Glanz durch Entfernen eines Teils des Materials und das Öffnen einiger Mikroporen auf der Oberfläche, wodurch das Produkt fleckempfindlicher wird. Daher lehnt Mirage Granito Ceramica SpA für diese Produkte jede Haftung ab.	Les produits JL 01 LUC, JL 02 LUC, JL 03 LUC, JL 04 LUC, JW 01 LUC, JW 02 LUC, JW 03 LUC, JW 11 LUC, JW 12 LUC, JW 14 LUC, JW 15 LUC, JW 17 LUC, JW 19 LUC, CP 01 LUC, CP 02 LUC, CP 03 LUC, CP 04 LUC, CP 05 LUC, WA 01 LUC, WA 08 LUC, WA 09 LUC, WA 10 LUC, ESPOIR CHAUD LUC, ESPOIR FROID LUC, comme tous les matériaux Mirage, répondent à la norme UNI EN ISO 14411. Il est précisé que les normes susmentionnées ne prévoient pas la nettoyabilité des traces de caoutchouc (chaussures, talons, bouchons de sièges, etc...), notamment dans les environnements où ces phénomènes sont souvent répétitifs. En général, l'usinage particulier de polissage ou de rodage rend la surface plus brillante en retirant une partie de matériau et, par conséquent, en ouvrant quelques micro-pores en surface, rendant ainsi le produit plus sensible aux taches. Par conséquent, Mirage Granito Ceramico SpA décline toute responsabilité sur ces produits.	Los productos JL 01 LUC, JL 02 LUC, JL 03 LUC, JL 04 LUC, JW 01 LUC, JW 02 LUC, JW 03 LUC, JW 11 LUC, JW 12 LUC, JW 14 LUC, JW 15 LUC, JW 17 LUC, JW 19 LUC, CP 01 LUC, CP 02 LUC, CP 03 LUC, CP 04 LUC, CP 05 LUC, WA 01 LUC, WA 08 LUC, WA 09 LUC, WA 10 LUC, ESPOIR CHAUD LUC, ESPOIR FROID LUC, como todos los materiales Mirage, cumplen la normativa UNI EN ISO 14411. Las normas citadas arriba no prevén la limpiabilidad de huellas de goma (zapatos, tacones, tapones de sillás, etc...), especialmente en aquellos ambientes en los que dichos fenómenos son mayormente posibles y repetitivos. En cualquier caso, los procesos específicos de Pulido y Lapeado suelen volver la superficie más brillante, retirando una parte de material y abriendo, por lo tanto, algunos microporos en la superficie, lo que hace que el producto sea más susceptible a las manchas. Mirage Granito Ceramico S.p.A. declina, por lo tanto, toda responsabilidad por lo que se refiere a dichos productos.	Изделия JL 01 LUC, JL 02 LUC, JL 03 LUC, JL 04 LUC, JW 01 LUC, JW 02 LUC, JW 03 LUC, JW 11 LUC, JW 12 LUC, JW 14 LUC, JW 15 LUC, JW 17 LUC, JW 19 LUC, CP 01 LUC, CP 02 LUC, CP 03 LUC, CP 04 LUC, CP 05 LUC, WA 01 LUC, WA 08 LUC, WA 09 LUC, WA 10 LUC, ESPOIR CHAUD LUC, ESPOIR FROID LUC, как и вся продукция Mirage, соответствуют условиям европейской стандарта UNI EN ISO 14411. Нормативные требования стандарта не предусматривают возможность очистки материала от следов резины (обува, каблочки, колпачки на ножках стульев и проч.), особенно в помещениях, где такие явления возможны и часто повторяются. Особый тип обработки, предполагающий частичную или полную полировку, делает поверхность более блестящей, при этом удаляется часть материала и тем самым открываются микропоры, что делает такую плитку более чувствительной к образу ванию пятен. По этим изделиям компания Mirage Granito Ceramico SpA не несет никакой ответственности.	JL 01 LUC, JL 02 LUC, JL 03 LUC, JL 04 LUC, JW 01 LUC, JW 02 LUC, JW 03 LUC, JW 11 LUC, JW 12 LUC, JW 14 LUC, JW 15 LUC, JW 17 LUC, JW 19 LUC, CP 01 LUC, CP 02 LUC, CP 03 LUC, CP 04 LUC, CP 05 LUC, WA 01 LUC, WA 08 LUC, WA 09 LUC, WA 10 LUC, ESPOIR CHAUD LUC, ESPOIR FROID LUC, 等产品，如同Mirage公司的所有材料一样，符合UNI EN ISO 14411标准。值得注意的是，上述标准无规定橡胶迹（鞋子、鞋跟、椅基等...）的可清洁性，尤其在出现这种现象更可能发生和重复的环境中。不过，总而言之，抛光或半抛光的专门加工令表面更光滑，为此去除了部分材料，从而在表面开上了一些小孔，使得产品更容易被污渍粘附。因此，Mirage Granito Ceramico SpA公司对这些产品不承担任何责任。
[IT]	[EN]	[DE]	[FR]	[ES]	[RU]	[中文]
Per effettuare un corretto lavaggio acido sulle superfici LUC, è necessario utilizzare un acido tamponato diluito in acqua, dimezzando la concentrazione acida consigliata dal produttore. È altresì fondamentale ridurre il periodo di contatto tra acido e lastre, procedendo, immediatamente dopo la pulizia, ad un abbondante risciacquo con acqua.	Per effectuer un correcto lavado ácido sobre las superficies LUC, es necesario utilizar un ácido taponado diluido en agua, reduciendo a la mitad la concentración ácida aconsejada por el fabricante. Es igualmente importante reducir el período de contacto entre el ácido y las losas, procediendo, inmediatamente después de la limpieza, a enjuagar abundantemente con agua.	Para efectuar un correcto lavado ácido sobre las superficies LUC, es necesario utilizar un ácido taponado diluido en agua, reduciendo a la mitad la concentración ácida aconsejada por el fabricante. Es igualmente importante reducir el período de contacto entre el ácido y las losas, procediendo, inmediatamente después de la limpieza, a enjuagar abundantemente con agua.	Il est aussi fondamental de réduire la période de contact entre l'acide et les dalles, en procédant aussitôt après le nettoyage à un rinçage abondant à l'eau.	Para efectuar un correcto lavado ácido sobre las superficies LUC, es necesario utilizar un ácido taponado diluido en agua, reduciendo a la mitad la concentración ácida aconsejada por el fabricante. Es igualmente importante reducir el período de contacto entre el ácido y las losas, procediendo, inmediatamente después de la limpieza, a enjuagar abundantemente con agua.	Para efectuar un correcto lavado ácido sobre las superficies LUC, es necesario utilizar un ácido taponado diluido en agua, reduciendo a la mitad la concentración ácida aconsejada por el fabricante. Es igualmente importante reducir el período de contacto entre el ácido y las losas, procediendo, inmediatamente después de la limpieza, a enjuagar abundantemente con agua.	我们强调的是，颜色很淡的单个调产品，如果是白色、超白或超黑（如JL 01, JL 02, JL 03, JL 04, JW 01, JW 02, JW 11, JW 12, JW 14, JW 15, JW 17, JW 19, CP 01, CP 02, CP 03, CP 04, WA 01, WA 08, WA 09, WA 10）更是如此，在任何表面上都相对不显眼。某些类型的污渍则相反，因为它们在较不浅色的产品上可能留下更显眼的痕迹或霉斑。因此，必须记住这些污渍需要更精细彻底和及时的清洁保养。日常维护必须使用消除痕迹或污渍的专用产品。（见第572页的表格）进行。
ALLURE Cura e pulizia: <ul style="list-style-type: none">Per la pulizia si possono utilizzare solo prodotti con Ph neutro (quali, a titolo esemplificativo ma non esaustivo, sapone di Marsiglia) e un panno morbido, senza parti ruvide o di metallo. Per pulizie più profonde è possibile utilizzare alcool puro al 95%. È assolutamente sconsigliato l'utilizzo di detersivi con Ph acido.	ALLURE Soin et nettoyage : <ul style="list-style-type: none">Pour le nettoyage, seuls des produits à pH neutre peuvent être utilisés (comme, à titre d'exemple et de manière non exhaustive, le savon de Marseille) et un chiffon souple, sans parties rugueuses ou métalliques. Pour un nettoyage plus profond, il est possible d'utiliser de l'alcool pur à 95%. Il est strictement déconseillé d'utiliser des détergents à pH acide.	ALLURE Cuidado y limpieza: <ul style="list-style-type: none">Para la limpieza se pueden emplear solo productos con Ph neutro (como, a modo de ejemplo pero no de manera exhaustiva, el jabón de Marsella) y un paño suave, sin partes ásperas o de metal. Para limpiezas más profundas es posible emplear alcohol puro al 95%. Es totalmente desaconsejada la utilización de detergentes de Ph ácido.	ALLURE Soin et nettoyage : <ul style="list-style-type: none">Pour le nettoyage, seuls des produits à pH neutre peuvent être utilisés (comme, à titre d'exemple et de manière non exhaustive, le savon de Marseille) et un chiffon souple, sans parties rugueuses ou métalliques. Pour un nettoyage plus profond, il est possible d'utiliser de l'alcool pur à 95%. Il est strictement déconseillé d'utiliser des détergents à pH acide.	ALLURE Cuidado y limpieza: <ul style="list-style-type: none">Para la limpieza se pueden emplear solo productos con Ph neutro (como, a modo de ejemplo pero no de manera exhaustiva, el jabón de Marsella) y un paño suave, sin partes ásperas o de metal. Para limpiezas más profundas es posible emplear alcohol puro al 95%. Es totalmente desaconsejada la utilización de detergentes de Ph ácido.	ALLURE Уход и уборка: <ul style="list-style-type: none">Для чистки использовать только моющие средства с нейтральным Ph (например, марсельское мыло и т.п.) и мягкую тряпку без жестких или металлических частей. Более стойкие загрязнения можно удалять чистым спиртом 95%. Категорически запрещается использовать моющие средства с кислотным Ph.	我们强调的是，颜色很淡的单个调产品，如果是白色、超白或超黑（如JL 01, JL 02, JL 03, JL 04, JW 01, JW 02, JW 11, JW 12, JW 14, JW 15, JW 17, JW 19, CP 01, CP 02, CP 03, CP 04, WA 01, WA 08, WA 09, WA 10）更是如此，在任何表面上都相对不显眼。某些类型的污渍则相反，因为它们在较不浅色的产品上可能留下更显眼的痕迹或霉斑。因此，必须记住这些污渍需要更精细彻底和及时的清洁保养。日常维护必须使用消除痕迹或污渍的专用产品。（见第572页的表格）进行。
ALLURE Cura e pulizia: <ul style="list-style-type: none">Per la pulizia si possono utilizzare solo prodotti con Ph neutro (quali, a titolo esemplificativo ma non esaustivo, sapone di Marsiglia) e un panno morbido, senza parti ruvide o di metallo. Per pulizie più profonde è possibile utilizzare alcool puro al 95%. È assolutamente sconsigliato l'utilizzo di detersivi con Ph acido.	ALLURE Pflege und Reinigung: <ul style="list-style-type: none">Zur Reinigung dürfen nur Produkte mit neutralem pH-Wert (wie beispielsweise Marseille Seife) verwendet werden und nur weiche Lappen ohne raue Teile oder Metall. Für eine sehr gründliche Reinigung kann 95%iger reiner Alkohol verwendet werden. Streng abgeraten wird von der Verwendung von Reinigungsmittel mit saurem pH-Wert.	ALLURE Pflege und Reinigung: <ul style="list-style-type: none">Zur Reinigung dürfen nur Produkte mit neutralem pH-Wert (wie beispielsweise Marseille Seife) verwendet werden und nur weiche Lappen ohne raue Teile oder Metall. Für eine sehr gründliche Reinigung kann 95%iger reiner Alkohol verwendet werden. Streng abgeraten wird von der Verwendung von Reinigungsmittel mit saurem pH-Wert.	ALLURE Pflege und Reinigung: <ul style="list-style-type: none">Zur Reinigung dürfen nur Produkte mit neutralem pH-Wert (wie beispielsweise Marseille Seife) verwendet werden und nur weiche Lappen ohne raue Teile oder Metall. Für eine sehr gründliche Reinigung kann 95%iger reiner Alkohol verwendet werden. Streng abgeraten wird von der Verwendung von Reinigungsmittel mit saurem pH-Wert.	ALLURE Cura e pulizia: <ul style="list-style-type: none">Per la pulizia si possono utilizzare solo prodotti con Ph neutro (quali, a titolo esemplificativo ma non esaustivo, sapone di Marsiglia) e un panno morbido, senza parti ruvide o di metallo. Per pulizie più profonde è possibile utilizzare alcool puro al 95%. È assolutamente sconsigliato l'utilizzo di detersivi con Ph acido.	ALLURE Pflege und Reinigung: <ul style="list-style-type: none">Zur Reinigung dürfen nur Produkte mit neutralem pH-Wert (wie beispielsweise Marseille Seife) verwendet werden und nur weiche Lappen ohne raue Teile oder Metall. Für eine sehr gründliche Reinigung kann 95%iger reiner Alkohol verwendet werden. Streng abgeraten wird von der Verwendung von Reinigungsmittel mit saurem pH-Wert.	我们强调的是，颜色很淡的单个调产品，如果是白色、超白或超黑（如JL 01, JL 02, JL 03, JL 04, JW 01, JW 02, JW 11, JW 12, JW 14, JW 15, JW 17, JW 19, CP 01, CP 02, CP 03, CP 04, WA 01, WA 08, WA 09, WA 10）更是如此，在任何表面上都相对不显眼。某些类型的污渍则相反，因为它们在较不浅色的产品上可能留下更显眼的痕迹或霉斑。因此，必须记住这些污渍需要更精细彻底和及时的清洁保养。日常维护必须使用消除痕迹或污渍的专用产品。（见第572页的表格）进行。
ALLURE Cura e pulizia: <ul style="list-style-type: none">Per la pulizia si possono utilizzare solo prodotti con Ph neutro (quali, a titolo esemplificativo ma non esaustivo, sapone di Marsiglia) e un panno morbido, senza parti ruvide o di metallo. Per pulizie più profonde è possibile utilizzare alcool puro al 95%. È assolutamente sconsigliato l'utilizzo di detersivi con Ph acido.	ALLURE Pflege und Reinigung: <ul style="list-style-type: none">Zur Reinigung dürfen nur Produkte mit neutralem pH-Wert (wie beispielsweise Marseille Seife) verwendet werden und nur weiche Lappen ohne raue Teile oder Metall. Für eine sehr gründliche Reinigung kann 95%iger reiner Alkohol verwendet werden. Streng abgeraten wird von der Verwendung von Reinigungsmittel mit saurem pH-Wert.	ALLURE Pflege und Reinigung: <ul style="list-style-type: none">Zur Reinigung dürfen nur Produkte mit neutralem pH-Wert (wie beispielsweise Marseille Seife) verwendet werden und nur weiche Lappen ohne raue Teile oder Metall. Für eine sehr gründliche Reinigung kann 95%iger reiner Alkohol verwendet werden. Streng abgeraten wird von der Verwendung von Reinigungsmittel mit saurem pH-Wert.	ALLURE Pflege und Reinigung: <ul style="list-style-type: none">Zur Reinigung dürfen nur Produkte mit neutralem pH-Wert (wie beispielsweise Marseille Seife) verwendet werden und nur weiche Lappen ohne raue Teile oder Metall. Für eine sehr gründliche Reinigung kann 95%iger reiner Alkohol verwendet werden. Streng abgeraten wird von der Verwendung von Reinigungsmittel mit saurem pH-Wert.	ALLURE Cura e pulizia: <ul style="list-style-type: none">Per la pulizia si possono utilizzare solo prodotti con Ph neutro (quali, a titolo esemplificativo ma non esaustivo, sapone di Marsiglia) e un panno morbido, senza parti ruvide o di metallo. Per pulizie più profonde è possibile utilizzare alcool puro al 95%. È assolutamente sconsigliato l'utilizzo di detersivi con Ph acido.	ALLURE Pflege und Reinigung: <ul style="list-style-type: none">Zur Reinigung dürfen nur Produkte mit neutralem pH-Wert (wie beispielsweise Marseille Seife) verwendet werden und nur weiche Lappen ohne raue Teile oder Metall. Für eine sehr gründliche Reinigung kann 95%iger reiner Alkohol verwendet werden. Streng abgeraten wird von der Verwendung von Reinigungsmittel mit saurem pH-Wert.	我们强调的是，颜色很淡的单个调产品，如果是白色、超白或超黑（如JL 01, JL 02, JL 03, JL 04, JW 01, JW 02, JW 11, JW 12, JW 14, JW 15, JW 17, JW 19, CP 01, CP 02, CP 03, CP 04, WA 01, WA 08, WA 09, WA 10）更是如此，在任何表面上都相对不显眼。某些类型的污渍则相反，因为它们在较不浅色的产品上可能留下更显眼的痕迹或霉斑。因此，必须记住这些污渍需要更精细彻底和及时的清洁保养。日常维护必须使用消除痕迹或污渍的专用产品。（见第572页的表格）进行。
ALLURE Cura e pulizia: <ul style="list-style-type: none">Per la pulizia si possono utilizzare solo prodotti con Ph neutro (quali, a titolo esemplificativo ma non esaustivo, sapone di Marsiglia) e un panno morbido, senza parti ruvide o di metallo. Per pulizie più profonde è possibile utilizzare alcool puro al 95%. È assolutamente sconsigliato l'utilizzo di detersivi con Ph acido.	ALLURE Pflege und Reinigung: <ul style="list-style-type: none">Zur Reinigung dürfen nur Produkte mit neutralem pH-Wert (wie beispielsweise Marseille Seife) verwendet werden und nur weiche Lappen ohne raue Teile oder Metall. Für eine sehr gründliche Reinigung kann 95%iger reiner Alkohol verwendet werden. Streng abgeraten wird von der Verwendung von Reinigungsmittel mit saurem pH-Wert.	ALLURE Pflege und Reinigung: <ul style="list-style-type: none">Zur Reinigung dürfen nur Produkte mit neutralem pH-Wert (wie beispielsweise Marseille Seife) verwendet werden und nur weiche Lappen ohne raue Teile oder Metall. Für eine sehr gründliche Reinigung kann 95%iger reiner Alkohol verwendet werden. Streng abgeraten wird von der Verwendung von Reinigungsmittel mit saurem pH-Wert.	ALLURE Pflege und Reinigung: <ul style="list-style-type: none">Zur Reinigung dürfen nur Produkte mit neutralem pH-Wert (wie beispielsweise Marseille Seife) verwendet werden und nur weiche Lappen ohne raue Teile oder Metall. Für eine sehr gründliche Reinigung kann 95%iger reiner Alkohol verwendet werden. Streng abgeraten wird von der Verwendung von Reinigungsmittel mit saurem pH-Wert.	ALLURE Cura e pulizia: <ul style="list-style-type: none">Per la pulizia si possono utilizzare solo prodotti con Ph neutro (quali, a titolo esemplificativo ma non esaustivo, sapone di Marsiglia) e un panno morbido, senza parti ruvide o di metallo. Per pulizie più profonde è possibile utilizzare alcool puro al 95%. È assolutamente sconsigliato l'utilizzo di detersivi con Ph acido.	ALLURE Pflege und Reinigung: <ul style="list-style-type: none">Zur Reinigung dürfen nur Produkte mit neutralem pH-Wert (wie beispielsweise Marseille Seife) verwendet werden und nur weiche Lappen ohne raue Teile oder Metall. Für eine sehr gründliche Reinigung kann 95%iger reiner Alkohol verwendet werden. Streng abgeraten wird von der Verwendung von Reinigungsmittel mit saurem pH-Wert.	我们强调的是，颜色很淡的单个调产品，如果是白色、超白或超黑（如JL 01, JL 02, JL 03, JL 04, JW 01, JW 02, JW 11, JW 12, JW 14, JW 15, JW 17, JW 19, CP 01, CP 02, CP 03, CP 04, WA 01, WA 08, WA 09, WA 10）更是如此，在任何表面上都相对不显眼。某些类型的污渍则相反，因为它们在较不浅色的产品上可能留下更显眼的痕迹或霉斑。因此，必须记住这些污渍需要更精细彻底和及时的清洁保养。日常维护必须使用消除痕迹或污渍的专用产品。（见第572页的表格）进行。
ALLURE Cura e pulizia: <ul style="list-style-type: none">Per la pulizia si possono utilizzare solo prodotti con Ph neutro (quali, a titolo esemplificativo ma non esaustivo, sapone di Marsiglia) e un panno morbido, senza parti ruvide o di metallo. Per pulizie più profonde è possibile utilizzare alcool puro al 95%. È assolutamente sconsigliato l'utilizzo di detersivi con Ph acido.	ALLURE Pflege und Reinigung: <ul style="list-style-type: none">Zur Reinigung dürfen nur Produkte mit neutralem pH-Wert (wie beispielsweise Marseille Seife) verwendet werden und nur weiche Lappen ohne raue Teile oder Metall. Für eine sehr gründliche Reinigung kann 95%iger reiner Alkohol verwendet werden. Streng abgeraten wird von der Verwendung von Reinigungsmittel mit saurem pH-Wert.	ALLURE Pflege und Reinigung: <ul style="list-style-type: none">Zur Reinigung dürfen nur Produkte mit neutralem pH-Wert (wie beispielsweise Marseille Seife) verwendet werden und nur weiche Lappen ohne raue Teile oder Metall. Für eine sehr gründliche Reinigung kann 95%iger reiner Alkohol verwendet werden. Streng abgeraten wird von der Verwendung von Reinigungsmittel mit saurem pH-Wert.	ALLURE Pflege und Reinigung: <ul style="list-style-type: none">Zur Reinigung dürfen nur Produkte mit neutralem pH-Wert (wie beispielsweise Marseille Seife) verwendet werden und nur weiche Lappen ohne raue Teile oder Metall. Für eine sehr gründliche Reinigung kann 95%iger reiner Alkohol verwendet werden. Streng abgeraten wird von der Verwendung von Reinigungsmittel mit saurem pH-Wert.	ALLURE Cura e pulizia: <ul style="list-style-type: none">Per la pulizia si possono utilizzare solo prodotti con Ph neutro (quali, a titolo esemplificativo ma non esaustivo, sapone di Marsiglia) e un panno morbido, senza parti ruvide o di metallo. Per pulizie più profonde è possibile utilizzare alcool puro al 95%. È assolutamente sconsigliato l'utilizzo di detersivi con Ph acido.	ALLURE Pflege und Reinigung: <ul style="list-style-type: none">Zur Reinigung dürfen nur Produkte mit neutralem pH-Wert (wie beispielsweise Marseille Seife) verwendet werden und nur weiche Lappen ohne raue Teile oder Metall. Für eine sehr gründliche Reinigung kann 95%iger reiner Alkohol verwendet werden. Streng abgeraten wird von der Verwendung von Reinigungsmittel mit saurem pH-Wert.	我们强调的是，颜色很淡的单个调产品，如果是白色、超白或超黑（如JL 01, JL 02, JL 03, JL 04, JW 01, JW 02, JW 11, JW 12, JW 14, JW 15, JW 17, JW 19, CP 01, CP 02, CP 03, CP 04, WA 01, WA 08, WA 09, WA 10）更是如此，在任何表面上都相对不显眼。某些类型的污渍则相反，因为它们在较不浅色的产品上可能留下更显眼的痕迹或霉斑。因此，必须记住这些污渍需要更精细彻底和及时的清洁保养。日常维护必须使用消除痕迹或污渍的专用产品。（见第572页的表格）进行。
ALLURE Cura e pulizia: <ul style="list-style-type: none">Per la pulizia si possono utilizzare solo prodotti con Ph neutro (quali, a titolo esemplificativo ma non esaustivo, sapone di Marsiglia) e un panno morbido, senza parti ruvide o di metallo. Per pulizie più profonde è possibile utilizzare alcool puro al 95%. È assolutamente sconsigliato l'utilizzo di detersivi con Ph acido.	ALLURE Pflege und Reinigung: <ul style="list-style-type: none">Zur Reinigung dürfen nur Produkte mit neutralem pH-Wert (wie beispielsweise Marseille Seife) verwendet werden und nur weiche Lappen ohne raue Teile oder Metall. Für eine sehr gründliche Reinigung kann 95%iger reiner Alkohol verwendet werden. Streng abgeraten wird von der Verwendung von Reinigungsmittel mit saurem pH-Wert.	ALLURE Pflege und Reinigung: <ul style="list-style-type: none">Zur Reinigung dürfen nur Produkte mit neutralem pH-Wert (wie beispielsweise Marseille Seife) verwendet werden und nur weiche Lappen ohne raue Teile oder Metall. Für eine sehr gründliche Reinigung kann 95%iger reiner Alkohol verwendet werden. Streng abgeraten wird von der Verwendung von Reinigungsmittel mit saurem pH-Wert.	ALLURE Pflege und Reinigung: <ul style="list-style-type: none">Zur Reinigung dürfen nur Produkte mit neutralem pH-Wert (wie beispielsweise Marseille Seife) verwendet werden und nur weiche Lappen ohne raue Teile oder Metall. Für eine sehr gründliche Reinigung kann 95%iger reiner Alkohol verwendet werden. Streng abgeraten wird von der Verwendung von Reinigungsmittel mit saurem pH-Wert.	ALLURE Cura e pulizia: <ul style="list-style-type: none">Per la pulizia si possono utilizzare solo prodotti con Ph neutro (quali, a titolo esemplificativo ma non esaustivo, sapone di Marsiglia) e un panno morbido, senza parti ruvide o di metallo. Per pulizie più profonde è possibile utilizzare alcool puro al 95%. È assolutamente sconsigliato l'utilizzo di detersivi con Ph acido.	ALLURE Pflege und Reinigung: <ul style="list-style-type: none">Zur Reinigung dürfen nur Produkte mit neutralem pH-Wert (wie beispielsweise Marseille Seife) verwendet werden und nur weiche Lappen ohne raue Teile oder Metall. Für eine sehr gründliche Reinigung kann 95%iger reiner Alkohol verwendet werden. Streng abgeraten wird von der Verwendung von Reinigungsmittel mit saurem pH-Wert.	我们强调的是，颜色很淡的单个调产品，如果是白色、超白或超黑（如JL 01, JL 02, JL 03, JL 04, JW 01, JW 02, JW 11, JW 12, JW 14, JW 15, JW 17, JW 19, CP 01, CP 02, CP 03, CP 04, WA 01, WA 08, WA 09, WA 10）更是如此，在任何表面上都相对不显眼。某些类型的污渍则相反，因为它们在较不浅色的产品上可能留下更显眼的痕迹或霉斑。因此，必须记住这些污渍需要更精细彻底和及时的清洁保养。日常维护必须使用消除痕迹或污渍的专用产品。（见第572页的表格）进行。
ALLURE Cura e pulizia: <ul style="list-style-type: none">Per la pulizia si possono utilizzare solo prodotti con Ph neutro (quali, a titolo esemplificativo ma non esaustivo, sapone di Marsiglia) e un panno morbido, senza parti ruvide o di metallo. Per pulizie più profonde è possibile utilizzare alcool puro al 95%. È assolutamente sconsigliato l'utilizzo di detersivi con Ph acido.	ALLURE Pflege und Reinigung: <ul style="list-style-type: none">Zur Reinigung dürfen nur Produkte mit neutralem pH-Wert (wie beispielsweise Marseille Seife) verwendet werden und nur weiche Lappen ohne raue Teile oder Metall. Für eine sehr gründliche Reinigung kann 95%iger reiner Alkohol verwendet werden. Streng abgeraten wird von der Verwendung von Reinigungsmittel mit saurem pH-Wert.	ALLURE Pflege und Reinigung: <ul style="list-style-type: none">Zur Reinigung dürfen nur Produkte mit neutralem pH-Wert (wie beispielsweise Marseille Seife) verwendet werden und nur weiche Lappen ohne raue Teile oder Metall. Für eine sehr gründliche Reinigung kann 95%iger reiner Alkohol verwendet werden. Streng abgeraten wird von der Verwendung von Reinigungsmittel mit saurem pH-Wert.	ALLURE Pflege und Reinigung: <ul style="list-style-type: none">Zur Reinigung dürfen nur Produkte mit neutralem pH-Wert (wie beispielsweise Marseille Seife) verwendet werden und nur weiche Lappen ohne raue Teile oder Metall. Für eine sehr gründliche Reinigung kann 95%iger reiner Alkohol verwendet werden. Streng abgeraten wird von der Verwendung von Reinigungsmittel mit saurem pH-Wert.	ALLURE Cura e pulizia: <ul style="list-style-type: none">Per la pulizia si possono utilizzare solo prodotti con Ph neutro (quali, a titolo esemplificativo ma non esaustivo, sapone di Marsiglia) e un panno morbido, senza parti ruvide o di metallo. Per pulizie più profonde è possibile utilizzare alcool puro al 95%. È assolutamente sconsigliato l'utilizzo di detersivi con Ph acido.	ALLURE Pflege und Reinigung: <ul style="list-style-type: none">Zur Reinigung dürfen nur Produkte mit neutralem pH-Wert (wie beispielsweise Marseille Seife) verwendet werden und nur weiche Lappen ohne raue Teile oder Metall. Für eine sehr gründliche Reinigung kann 95%iger reiner Alkohol verwendet werden. Streng abgeraten wird von der Verwendung von Reinigungsmittel mit saurem pH-Wert.	我们强调的是，颜色很淡的单个调产品，如果是白色、超白或超黑（如JL 01, JL 02, JL 03, JL 04, JW 01, JW 02, JW 11, JW 12, JW 14, JW 15, JW 17, JW 19, CP 01, CP 02, CP 03, CP 04, WA 01, WA 08, WA 09, WA 10）更是如此，在任何表面上都相对不显眼。某些类型的污渍则相反，因为它们在较不浅色的产品上可能留下更显眼的痕迹或霉斑。因此，必须记住这些污渍需要更精细彻底和及时的清洁保养。日常维护必须使用消除痕迹或污渍的专用产品。（见第572页的表格）进行。
ALLURE Cura e pulizia: <ul style="list-style-type: none">Per la pulizia si possono utilizzare solo prodotti con Ph neutro (quali, a titolo esemplificativo ma non esaustivo, sapone di Marsiglia) e un panno morbido, senza parti ruvide o di metallo. Per pulizie più profonde è possibile utilizzare alcool puro al 95%. È assolutamente sconsigliato l'utilizzo di detersivi con Ph acido.	ALLURE Pflege und Reinigung: <ul style="list-style-type: none">Zur Reinigung dürfen nur Produkte mit neutralem pH-Wert (wie beispielsweise Marseille Seife) verwendet werden und nur weiche Lappen ohne raue Teile oder Metall. Für eine sehr gründliche Reinigung kann 95%iger reiner Alkohol verwendet werden. Streng abgeraten wird von der Verwendung von Reinigungsmittel mit saurem pH-Wert.	ALLURE Pflege und Reinigung: <ul style="list-style-type: none">Zur Reinigung dürfen nur Produkte mit neutralem pH-Wert (wie beispielsweise Marseille Seife) verwendet werden und nur weiche Lappen ohne raue Teile oder Metall. Für eine sehr gründliche Reinigung kann 95%iger reiner Alkohol verwendet werden. Streng abgeraten wird von der Verwendung von Reinigungsmittel mit saurem pH-Wert.	ALLURE Pflege und Reinigung: <ul style="list-style-type: none">Zur Reinigung dürfen nur Produkte mit neutralem pH-Wert (wie beispielsweise Marseille Seife) verwendet werden und nur weiche Lappen ohne raue Teile oder Metall. Für eine sehr gründliche Reinigung kann 95%iger reiner Alkohol verwendet werden. Streng abgeraten wird von der Verwendung von Reinigungsmittel mit saurem pH-Wert.	ALLURE Cura e pulizia: <ul style="list-style-type: none">Per la pulizia si possono utilizzare solo prodotti con Ph neutro (quali, a titolo esemplificativo ma non esaustivo, sapone di Marsiglia) e un panno morbido, senza parti ruvide o di metallo. Per pulizie più profonde è possibile utilizzare alcool puro al 95%. È assolutamente sconsigliato l'utilizzo di detersivi con Ph acido.	ALLURE Pflege und Reinigung: <ul style="list-style-type: none">Zur Reinigung dürfen nur Produkte mit neutralem pH-Wert (wie beispielsweise Marseille Seife) verwendet werden und nur weiche Lappen ohne raue Teile oder Metall. Für eine sehr gründliche Reinigung kann 95%iger reiner Alkohol verwendet werden. Streng abgeraten wird von der Verwendung von Reinigungsmittel mit saurem pH-Wert.	我们强调的是，颜色很淡的单个调产品，如果是白色、超白或超黑（如JL 01, JL 02, JL 03, JL 04, JW 01, JW 02, JW 11, JW 12, JW 14, JW 15, JW 17, JW 19, CP 01, CP 02, CP 03, CP 04, WA 01, WA 08, WA 09, WA 10）更是如此，在任何表面上都相对不显眼。某些类型的污渍则相反，因为它们在较不浅色的产品上可能留下更显眼的痕迹或霉斑。因此，必须记住这些污渍需要更精细彻底和及时的清洁保养。日常维护必须使用消除痕迹或污渍的专用产品。（见第572页的表格）进行。
ALLURE Cura e pulizia: <ul style="list-style-type: none">Per la pulizia si possono utilizzare solo prodotti con Ph neutro (quali, a titolo esemplificativo ma non esaustivo, sapone di Marsiglia) e un panno morbido, senza parti ruvide o di metallo. Per pulizie più profonde è possibile utilizzare alcool puro al 95%. È assolutamente sconsigliato l'utilizzo di detersivi con Ph acido.	ALLURE Pflege und Reinigung: <ul style="list-style-type: none">Zur Reinigung dürfen nur Produkte mit neutralem pH-Wert (wie beispielsweise Marseille Seife) verwendet werden und nur weiche Lappen ohne raue Teile oder Metall. Für eine sehr gründliche Reinigung kann 95%iger reiner Alkohol verwendet werden. Streng abgeraten wird von der Verwendung von Reinigungsmittel mit saurem pH-Wert.	ALLURE Pflege und Reinigung: <ul style="list-style-type: none">Zur Reinigung dürfen nur Produkte mit neutralem pH-Wert (wie beispielsweise Marseille Seife) verwendet werden und nur weiche Lappen ohne raue Teile oder Metall. Für eine sehr gründliche Reinigung kann 95%iger reiner Alkohol verwendet werden. Streng abgeraten wird von der Verwendung von Reinigungsmittel mit saurem pH-Wert.	ALLURE Pflege und Reinigung: <ul style="list-style-type: none">Zur Reinigung dürfen nur Produkte mit neutralem pH-Wert (wie beispielsweise Marseille Seife) verwendet werden und nur weiche Lappen ohne raue Teile oder Metall. Für eine sehr gründliche Reinigung kann 95%iger reiner Alkohol verwendet werden. Streng abgeraten wird von der Verwendung von Reinigungsmittel mit saurem pH-Wert.	ALLURE Cura e pulizia: <ul style="list-style-type: none">Per la pulizia si possono utilizzare solo prodotti con Ph neutro (quali, a titolo esemplificativo ma non esaustivo, sapone di Marsiglia) e un panno morbido, senza parti ruvide o di metallo. Per pulizie più profonde è possibile utilizzare alcool puro al 95%. È assolutamente sconsigliato l'utilizzo di detersivi con Ph acido.	ALLURE Pflege und Reinigung: <ul style="list-style-type: none">Zur Reinigung dürfen nur Produkte mit neutralem pH-Wert (wie beispielsweise Marseille Seife) verwendet werden und nur weiche Lappen ohne raue Teile oder Metall. Für eine sehr gründliche Reinigung kann 95%iger reiner Alkohol verwendet werden. Streng abgeraten wird von der Verwendung von Reinigungsmittel mit saurem pH-Wert.	我们强调的是，颜色很淡的单个调产品，如果是白色、超白或超黑（如JL 01, JL 02, JL 03, JL 04, JW 01, JW 02, JW 11, JW 12, JW 14, JW 15, JW 17, JW 19, CP 01, CP 02, CP 03, CP 04, WA 01, WA 08, WA 09, WA 10）更是如此，在任何表面上都相对不显眼。某些类型的污渍则相反，因为它们在较不浅色的产品上可能留下更显眼的痕迹或霉斑。因此，必须记住这些污渍需要更精细彻底和及时的清洁保养。日常维护必须使用消除痕迹或污渍的专用产品。（见第572页的表格）进行。
ALLURE Cura e pulizia: <ul style="list-style-type: none">Per la pulizia si possono utilizzare solo prodotti con Ph neutro (quali, a titolo esemplificativo ma non esaustivo, sapone di Marsiglia) e un panno morbido, senza parti ruvide o di metallo. Per pulizie più profonde è possibile utilizzare alcool puro al 95%. È assolutamente sconsigliato l'utilizzo di detersivi con Ph acido.	ALLURE Pflege und Reinigung: <ul style="list-style-type: none">Zur Reinigung dürfen nur Produkte mit neutralem pH-Wert (wie beispielsweise Marseille Seife) verwendet werden und nur weiche Lappen ohne raue Teile oder Metall. Für eine sehr gründliche Reinigung kann 95%iger reiner Alkohol verwendet werden. Streng abgeraten wird von der Verwendung von Reinigungsmittel mit saurem pH-Wert.	ALLURE Pflege und Reinigung: <ul style="list-style-type: none">Zur Reinigung dürfen nur Produkte mit neutralem pH-Wert (wie beispielsweise Marseille Seife) verwendet werden und nur weiche Lappen ohne raue Teile oder Metall. Für eine sehr gründliche Reinigung kann 95%iger reiner Alkohol verwendet werden. Streng abgeraten wird von der Verwendung von Reinigungsmittel mit saurem pH-Wert.	ALLURE Pflege und Reinigung: <ul style="list-style-type: none">Zur Reinigung dürfen nur Produkte mit neutralem pH-Wert (wie beispielsweise Marseille Seife) verwendet werden und nur weiche Lappen ohne raue Teile oder Metall. Für eine sehr gründliche Reinigung kann 95%iger reiner Alkohol verwendet werden. Streng abgeraten wird von der Verwendung von Reinigungsmittel mit saurem pH-Wert.	ALLURE Cura e pulizia: <ul style="list-style-type: none">Per la pulizia si possono utilizzare solo prodotti con Ph neutro (quali, a titolo esemplificativo ma non esaustivo, sapone di Marsiglia) e un panno morbido, senza parti ruvide o di metallo. Per pulizie più profonde è possibile utilizzare alcool puro al 95%. È assolutamente sconsigliato l'utilizzo di detersivi con Ph acido.	ALLURE Pflege und Reinigung: <ul style="list-style-type: none">Zur Reinigung dürfen nur Produkte mit neutralem pH-Wert (wie beispielsweise Marseille Seife) verwendet werden und nur weiche Lappen ohne raue Teile oder Metall. Für eine sehr gründliche Reinigung kann 95%iger reiner Alkohol verwendet werden. Streng abgeraten wird von der Verwendung von Reinigungsmittel mit saurem pH-Wert.	我们强调的是，颜色很淡的单个调产品，如果是白色、超白或超黑（如JL 01, JL 02, JL 03, JL 04, JW 01, JW 02, JW 11, JW 12, JW 14, JW 15, JW 17, JW 19, CP 01, CP 02, CP 03, CP 04, WA 01, WA 08, WA 09, WA 10）更是如此，在任何表面上都相对不显眼。某些类型的污渍则相反，因为它们在较不浅色的产品上可能留下更显眼的痕迹或霉斑。因此，必须记住这些污渍需要更精细彻底和及时的清洁保养。日常维护必须使用消除痕迹或污渍的专用产品。（见第572页的表格）进行。
ALLURE Cura e pulizia: <ul style="list-style-type: none">Per la pulizia si possono utilizzare solo prodotti con Ph neutro (quali, a titolo esemplificativo ma non esaustivo, sapone di Marsiglia) e un panno morbido, senza parti ruvide o di metallo. Per pulizie più profonde è possibile utilizzare alcool puro al 95%. È assolutamente sconsigliato l'utilizzo di detersivi con Ph acido.	ALLURE Pflege und Reinigung: <ul style="list-style-type: none">Zur Reinigung dürfen nur Produkte mit neutralem pH-Wert (wie beispielsweise Marseille Seife) verwendet werden und nur weiche Lappen ohne raue Teile oder Metall. Für eine sehr gründliche Reinigung kann 95%iger reiner Alkohol verwendet werden. Streng abgeraten wird von der Verwendung von Reinigungsmittel mit saurem pH-Wert.	ALLURE Pflege und Reinigung: <ul style="list-style-type: none">Zur Reinigung dürfen nur Produkte mit neutralem pH-Wert (wie beispielsweise Marseille Seife) verwendet werden und nur weiche Lappen ohne raue Teile oder Metall. Für eine sehr gründliche Reinigung kann 95%iger reiner Alkohol verwendet werden. Streng abgeraten wird von der Verwendung von Reinigungsmittel mit saurem pH-Wert.				

TECHNICAL DATA AND CERTIFICATIONS

PRODOTTI PER LA PULIZIA

Cleaning Products | Reinigungsprodukte | Produits de nettoyage

Productos de limpieza | Продукты для чистки | 清洁产品

TIPOLOGIE DI DETERGENTI Dove è consentita la vendita	A
TYPES OF DETERGENTS Where sales are permitted	SOLVENTI (candeggina, acqua-ragia, acetone, trielina, diluente alla nitro) SOLVENTS (bleaching solution, oil of turpentine, acetone, trichloroethylene, nitrate based thinner) LÖSUNGSMITTEL (Bleichmittel, Terpentin, Azeton, Trichloräthylen, Nitroverdünner) SOLVANTS (eau de Javel, essence de térébenthine, acétone, trichloréthylène, diluant nitro-cellulosique) DISOLVENTES (lejía, aguarrás, acetona, tricloroetileno, disolvente nitro) РАСТВОРИТЕЛИ (отбеливатель, скипидар, ацетон, трихлорэтилен, разбавитель на основе селитры) 溶剂 (漂白剂, 松节油, 丙酮, 三氯乙烯, 硝基稀释剂)
ART DER REINIGUNGSMITTEL Wo der Verkauf erlaubt ist	
TYPES DE DÉTERGENTS Où la vente est permise	B ACIDI (acido muriatico, acido cloridrico, acido fosforico) ACIDS (muriatic acid, hydrochloric acid, phosphoric acid) SÄUREN (Chlorwasserstoffsäure, Salzsäure, Phosphorsäure) ACIDES (acide chlorhydrique, acide phosphorique) ÁCIDOS (ácido muriático, ácido clorhídrico, ácido fosfórico) КИСЛОТЫ (соляная кислота, хлористоводородная кислота, фосфорная кислота) 酸 (盐酸, 氢氯酸, 磷酸)
TIPOS DE DETERGENTES Donde está consentida la venta	
ТИП МОЮЩЕГО СОСТАВА Где разрешена их продажа	
洗涤剂的种类 允许出售的地方	C DETERGENTI A BASE ALCALINA - ALCALI (detergenti professionali alcalini) ALKALINE BASED DETERGENTS - ALKALI (alkaline-based professional detergents) REINIGUNGSMITTEL AUF ALKALISCHER BASIS – ALKALI (professionelle alkalische Reinigungsmittel) NETTOYANTS A BASE ALCALINE – ALCALI (nettoyants professionnels alcalins) DETERGENTES DE BASE ALCALINA – ALCALIS (detergentes profesionales alcalinos) ЩЕЛОЧНЫЕ МОЮЩИЕ СРЕДСТВА – ЩЕЛОЧИ (профессиональные щелочные моющие средства) 碱性洗涤剂 (专业碱性洗涤剂)

	Tipologie di Detergenti Types of Detergents		A		B		C	
	Superficie	Finish	NAT SP ST SLK	LUC PRL	NAT SP ST SLK	LUC PRL	NAT SP ST SLK	LUC PRL
TIPI DI MACCHIE - TYPES OF STAIN - FLECKENARTEN - TYPES DE TACHES - TIPOS DE MANCHAS - ТИПЫ ПЯТЕН - 污渍类型								
Birra - Beer - Bier - Bière - Cerveza - Пиво - 啤酒						■	■	
Caffè - Coffee - Kaffee - Café - Café - Кофе - 咖啡				■				
Calcare - Lime - Kalk - Calcaire - Cal - Известь - 水垢					■	■		
Catrame - Tar - Teer - Goudron - Alquitrán - Деготь - 焦油		■	■					
Cemento - Cement - Zement - Ciment - Cemento - Цемент - 水泥					■	■		
Cera di candela - Candle wax - Kerzenwachs - Cire de bougie - Cera de vela - Свечной воск - 蜡烛		■	■					
Coca Cola - Кока Кола - 可口可乐				■				
Colla - Glue - Klebstoff - Colle - Adhesivo - Клей - 胶水		■	■					
Gelato - Ice cream - Eis - Crème glacée - Helado - Мороженое - 冰淇淋								
Gomma da masticare - Chewing gum - Kaugummi - Chewing-gum - Goma de mascar - Жевательная резинка - 口香糖		■	■				■	
Gomma di pneumatico, scarpe - Tyre rubber, shoes - Reifengummi, Schuhe - Traces de pneus, chaussures - Goma de neumático, zapatos - Шины, обувь - 橡胶轮胎, 鞋		■	■					
Grasso, Olio - Grease, Oil - Fett, Öl - Graisse, huile - Grasa, Aceite - Жир, масло - 油脂, 油							■	■
Inchiostro - Ink - Tinte - Encre - Tinta - Чернила - 墨		■	■					
Nicotina - Nicotine - Nikotin - Nicotine - Nicotina - Никотин - 尼古丁		■	■					
Pennarello - Felt-tip pen - Filzstift - Feutre - Rotulador - Фломастер - 标号笔		■	■					
Resine - Resins - Harze - Résines - Resinas - Смола - 树脂		■	■					
Ruggine - Rust - Rost - Rouille - Óxido - Ржавчина - 铁锈					■	■		
Smalto per unghie - Nail polish - Nagellack - Vernis à ongles - Esmalte de uñas - Лак для ногтей - 指甲油		■	■					
Sigaretta - Cigarette - Zigarette - Cigarette - Cigarrillo - Сигарета - 香烟					■	■		
Vernice murale - Wall paint - Wandfarbe - Peinture - Pintura mural - Краска для стен - 墙面漆		■	■	■	■			
Vino - Wine - Wein - Vin - Vino - Вино - 葡萄酒			■					

Per informazioni e consigli Vi invitiamo a contattare il rivenditore Mirage più vicino a Voi o Mirage Granito Ceramico S.p.A. _ For more information, contact your nearest Mirage dealer or Mirage Granito Ceramico S.p.A. _ Für weitere Informationen und Hinweise wenden Sie sich bitte an den nächsten Miragehändler oder an Mirage Granito Ceramico S.p.A. _ Pour obtenir des informations et des conseils, nous vous invitons à contacter le revendeur Mirage le plus proche ou Mirage Granito Ceramico S.p.A. _ Para obtener información y consejos, les invitamos a que se pongan en contacto con el revendedor Mirage más cercano a Uds. o con Mirage Granito Ceramico S.p.A. _ За информацией и советами обращайтесь к ближайшему к вам дилеру Mirage или непосредственно в компанию Mirage Granito Ceramico S.p.A. _ 有关信息和建议, 请联系离您最近的Mirage经销商或者Mirage Granito Ceramico S.p.A公司

CALIBRO/DIMENSIONI DI FABBRICAZIONE (W) MM.

Caliber/Work Size (W) mm. | Kaliber/Werkmaße (W) mm. | Calibre/dimension de fabrication (W) mm.

Calibre/dimension de Fabricacion (W) mm. | Калибр / производственные размеры (w) мм.

DIMENSIONI MODULARI *			
MODULAR SIZES - MODULARE VORZUGMASSE - DIMENSIONS MODULAIRES - DIMENSIONES MODULARES - МОДУЛЬНЫЕ РАЗМЕРЫ			
I valori dichiarati sono indicativi e comunque rispettano le variazioni previste dalla norma. _ The stated values are approximate, and in any case they comply the variations provided by the law.			
COLLEZIONE	CALIBRO	FORMATO NOMINALE	FORMATO REALE
JEWELS	P	150x600 / 6"x24"	147,2x595
		600x600 / 24"x24"	595x595
		600x1197 / 24"x48"	595x1192
	M	1200x1200 / 48"x48"	1198x1198
		1200x2400 / 48"x96"	1198x2398
		1200x2780 / 48"x110"	1198x2778
1600x1600 / 63"x63"		1598x1598	
1600x3200 / 63"x126"	1598x3198		
JURUPA - KORU - NOON SIGNATURE - OUDH - KAO	L	200x1200 / 8"x48"	196x1198
		200x1800 / 8"x72"	196x1795
		300x1200 / 12"x48"	296x1198
	M	250x1500 / 10"x60"	248x1498
		300x2400 / 12"x96"	298x2398
		200x2780 / 8"x110"	198x2398
1200x2780 / 48"x110"	1198x2778		
REFLET	P	200x600 / 8"x24" ANTIQUE	197x595
	M	200x600 / 8"x24" SKETCH	198x598
CLAY - COSMOPOLITAN - DIJON - ELYSIAN GLOCAL - JOLIE - LEMMY - NA.ME - NORR NOVEMBER - QUARZITI 2.0 - SILVERLAKE WANDERLUST - VICEVERSA - MÖTLEY - NYUMA	M	150x600 / 6"x24"	148x598
		300x600 / 12"x24"	298x598
		600x600 / 24"x24"	598x598
		300x1200 / 12"x48"	298x1198
		600x1200 / 24"x48"	598x1198
		450x900 / 18"x36"	448x898
		200x800 / 8"x31½"	198x798
		400x800 / 15¾"x31½"	398x798
		800x800 / 31½"x31½"	798x798
		800x1600 / 31½"x63"	798x1598
		1200x1200 / 48"x48"	1198x1198
		1200x2400 / 48"x96"	1198x2398
		1200x2780 / 48"x110"	1198x2778
		1600x1600 / 63"x63"	1598x1598
		1600x3200 / 63"x126"	1598x3198
* Posa modulare con fuga di 2 mm. - Recommended modular installation joint 2 mm. - Modulverlegung mit 2 mm. Fuge Pose modulaire avec joint de 2 mm. - Colocacion modular con junta de 2 mm. - Модульная укладка с зазором 2 мм.			

SPESSORE 20 mm / 30 mm 20 MM / 30 MM THICKNESS			
I valori dichiarati sono indicativi e comunque rispettano le variazioni previste dalla norma. _ The stated values are approximate, and in any case they comply the variations provided by the law.			
COLLEZIONE	CALIBRO	FORMATO NOMINALE	FORMATO REALE
DIJON - ELYSIAN - JURUPA - KAO GLOCAL - LEMMY - NA.ME - NAU 2.0 NORR - NOVEMBER - OFFICINE RAIL - QUARZITI 2.0 - SILVERLAKE MÖTLEY - NYUMA - OUDH - TWENTY	M	600x600 / 24"x24"	598x598
		600x1200 / 24"x48"	598x1198
		600x900 / 24"x36"	598x898
		900x900 / 36"x36"	898x898
		800x800 / 31½"x31½"	798x798
		450x900 / 16"x48"	448x898
		1200x1200 / 48"x48"	1198x1198
		300x1200 / 12"x48"	298x1198
		300x2400 / 12"x96"	298x2398
NOON	Q	197x1200 / 8"x48"	194x1198

TECHNICAL DATA AND CERTIFICATIONS

BIG SIZES - 1200x2400 / 1200x2780 / 1600x1600 / 1600x3200 / 1620x3240

BIG SIZES - 48"x96" / 48"x110" / 63"x63" / 63"x126"

Collezione Collection	Colore Color	1200x2780	1200x2780	1200x2780	1200x2780	1600x1600	1600x3200	1200x2400	1620x3240
		48"x110"	Kit Vein M.	Line	Arrow	Lace	63"x63"	63"x126"	48"x96"
		± 6 mm						± 9 mm	± 12 mm
COSMOPOLITAN	STATUARIO EXTRA CP 01	LUC/NAT	LUC					LUC	
	CALACATTA GOLD CP 02	LUC/NAT	LUC					LUC	
	ARABESCATO ORO CP 03	LUC						LUC	
	STATUARIO FANTASTICO CP 04	LUC							
	WHITE CRYSTAL CP 05	LUC						LUC	
	MYSTIC GREY CP 06	LUC						LUC	
	AMAZZONITE CP 07	LUC						LUC	
JEWELS	BIANCO STATUARIO JW 01	LUC						LUC	
	CALACATTA REALE JW 02	LUC				LUC	LUC	LUC	
	ROYAL JW 03	LUC						LUC	SLK
	BLACK GOLD JW 11	LUC							
	BIANCO LUNENSIS JW 12	LUC	LUC					LUC	SLK
	SENECA WHITE WJ 14	LUC/NAT	LUC			LUC	LUC	LUC	LUC/SLK
	ONYKS JW 15	LUC				LUC	LUC	LUC	
	RAYMI JW 16	LUC/NAT				LUC	LUC	LUC	
	MOONLESS JW 17	LUC				LUC	LUC	LUC	
	EXTRAWHITE JW 19	LUC/NAT				LUC	LUC	LUC	
JOLIE	STATUARIO FINE JL 01	LUC/SP	LUC						
	CALACATTA SELECT JL 02	LUC/SP	LUC						
	CALACATTA VENA ANTICA JL 03	LUC	LUC						SLK
	WASHINGTON JL 04	LUC/SP	LUC	LUC					SLK
	TUNDRA LITE JL 05	LUC/SP							
	PIETRA GREY JL 06	LUC/SP							SLK
	VERDE ALPI JL 07	LUC							
WANDERLUST	CALACATTA COPPER WA 01	LUC							
	LIBECCIO ANTICO WA 02	LUC							
	ONICE BROWN WA 03	LUC							
	AZUL PURO WA 04	LUC							
	LABRADORITE WA 05	LUC							
	DARK COSMO WA 06	LUC							
	SAINT LAURENT WA 07	LUC							
	AGATA BLUE WA 08	LUC							
	AGATA MULTICOLOR WA 09	LUC							
	AGATA BLACK WA 10	LUC							
	SIBERIAN MALACHITE WA 11	LUC							
	GALWAY GREEN WA 12	LUC							
	FOUR SEASONS WA 13	LUC							
GLOCAL	CLEAR GC 01	SP				SP	SP	SP	SP
	PERFECT GC 02	SP				SP	SP	SP	SP
	IDEAL GC 03	SP				SP	SP	SP	SP
	TYPE GC 04							SP	
	CLASSIC GC 05							SP	
	ABSOLUTE GC 06	SP							
	SUGAR GC 07	SP				SP	SP	SP	SP
	GINGER GC 10	SP				SP	SP	SP	SP
	NEBULA GC 11	SP							
	ESSENCE GC 12	SP							
	JOURNEY GC 13	SP							
	SLIGHT GC 14	SP							
	YOUTH GC 15	SP							
LUMINA GC 18	SP								
IRON GC 20	SP				SP	SP			
CORTEN GC 21	SP								

BIG SIZES - 1200x2400 / 1200x2780 / 1600x1600 / 1600x3200 / 1620x3240

BIG SIZES - 48"x96" / 48"x110" / 63"x63" / 63"x126"

Collezione Collection	Colore Color	1200x2780	1200x2780	1200x2780	1200x2780	1600x1600	1600x3200	1200x2400	1620x3240
		48"x110"	Kit Vein M.	Line	Arrow	Lace	63"x63"	63"x126"	48"x96"
		± 6 mm						± 9 mm	± 12 mm
CLAY	CALM CL 01	SP							
	DELIGHT CL 02	SP							
	AWAKE CL 03	SP							
	FANCY CL 04	SP							
	VERVE CL 05	SP							
	SHY CL 06	SP							
	TRUST CL 07	SP							
	KARMA CL 08	SP							
LEMMY	PALLADIUM LY 01	SP							
	NIMBUS LY 02	SP							
	EXCALIBUR LY 03	SP							
	VENOM LY 04	SP							
NYUMA	AFTERGLOW LY 05	SP							
	QUICKLIME NY 01	SP							
	PORTLAND NY 02	SP							
	TORCHING NY 03	SP							
	TALCUM NY 05	SP							
VICEVERSA	COCCO VV 01	SP							
	PERLA VV 02	SP							
	NUBE VV 03	SP						SP	
	CALCESTRUZZO VV 04	SP							
	VAIO VV 05	SP							
	LINO VV 06	SP							
	ALBA VV 07	SP						SP	
	CORTECCIA VV 08	SP							
ELYSIAN	MEDITERRANEA EY 01	SP		SP	SP				SP
	DESERT STONE EY 02	SP		SP	SP				SP
	BEIGE CATALAN EY 03	SP							SP
	GRIS CATALAN EY 04	SP							
	TRAVERTINO LIGHT EY 07	SP		SP					SP
	TRAVERTINO DARK EY 08	SP							
	GOLD CATALAN EY 09	SP							
	TRAVERTINO LUMI EY 10	SP		SP					SP
	TRAVERTINO SMOKE EY 11	SP		SP					
	RIO MT 01	SP							
	MONTEREY MT 02	SP							
MÓTLEY	WEMBLEY MT 03	SP							
	ALTAMONT MT 04	SP							
	WOODSTOCK MT 05	SP							
	LIVERPOOL MT 06	SP							
	GRÀ RR 02	NAT					NAT	NAT	SP
	FARGE RR 05	NAT							SP
NORR	HAV RR 06	NAT							
	ÖKEN RR 08	NAT							
	GRUS RR 09	NAT							
OUDH	JINKOH OU 03	SP							
	PINO OU 04	SP							
PAPIER	LAOS OU 05	SP							
	ENCANTO GOLD	SP							
	CAMILLE GOLD	SP							
	CAMILLE ROSE	SP							
	AQUARELLE ROSE	SP							
	AQUARELLE VERT	SP							
	ESPOIR CHAUD	LUC							
ESPOIR FROID	LUC								

ANTISLIP FLOORS (R10 - R11 - R12)

Collezione Collection	Superficie Finish	DIN 51130	DIN 51097	ENV 12633	BS 7976 sl.96-45	BS 7976 sl-55-TRL	Colori Colours
CLAY	NAT	R10	A+B	classe 2	≥ 0,36	≥ 0,36	CL01 CL02 CL03 CL04 CL05 CL06 CL07
DIJON	ST	R11	-	-	-	-	DJ01 DJ02 DJ03 DJ04 DJ05
DIJON EVO 2/E™ - 20 mm	ST	R11	A+B+C	classe 3	≥ 0,36	≥ 0,36	DJ01 DJ02 DJ03 DJ04
ELYSIAN	NAT	R10	A+B	classe 2	≥ 0,36	≥ 0,36	EY01 EY02 EY03 EY04 EY05 EY07 EY08 EY09
ELYSIAN	ST	R11	A+B+C	classe 3	≥ 0,36	≥ 0,36	EY01 EY02 EY03 EY04 EY05 EY09
ELYSIAN EVO 2/E™ - 20 mm	ST	R11	A+B+C	classe 3	≥ 0,36	≥ 0,36	EY01 EY02 EY03 EY04 EY05 EY07 EY08 EY09
ELYSIAN TRAVERTINI	NAT	R10	A+B	classe 2	≥ 0,36	≥ 0,36	EY07 EY08 EY10 EY11 EY12 EY13 EY14
ELYSIAN TRAV. EVO 2/E™ - 20 mm	ST	R11	A+B+C	classe 3	≥ 0,36	≥ 0,36	EY07 EY08 EY11 EY12 EY13 EY14
GLOCAL	NAT	R10	A	classe 2	≥ 0,36	-	GC01 GC02 GC03 GC04 GC05 GC06 GC07 GC08 GC09 GC10
GLOCAL	ST	R11	A+B+C	classe 3	≥ 0,36	≥ 0,36	GC01 GC02 GC03 GC04 GC05 GC06 GC07 GC08 GC09 GC10
GLOCAL EVO 2/E™ - 20 mm / 30 mm	ST	R11	A+B+C	classe 3	≥ 0,36	≥ 0,36	GC03 GC04 GC05 GC06 GC08
JURUPA	GP	R11	A+B+C	classe 3	≥ 0,36	≥ 0,36	JP02 JP03 JP04
JURUPA EVO 2/E™ - 20 mm	RD	R11	A+B+C	-	-	-	JP01 JP02 JP03 JP04 JP05
KAO	NAT	R10	A	classe 2	≥ 0,36	-	KA01 KA02 KA03 KA04 KA05
KAO EVO 2/E™ - 20 mm	RD	R11	A+B+C	-	-	-	KA02 KA03 KA04 KA12 KA13 KA14
LEMMY EVO 2/E™ - 20 mm	ST	R11	A+B+C	classe 3	≥ 0,36	≥ 0,36	LY02 LY03 LY04 LY09
NAME	BC	R11	A+B+C	classe 3	≥ 0,36	-	NE10 NE11 NE12 NE13 NE21 NE22 NE31
NAME	NAT	R10	A+B	classe 2	≥ 0,36	-	NE21 NE22
NAME EVO 2/E™ - 20 mm	ST	R11	A+B+C	classe 3	≥ 0,36	-	NE10 NE11 NE12 NE21 NE22 NE31
NAU 2.0 EVO 2/E™ - 20 mm	RD	R11	A+B	classe 3	≥ 0,36	-	NA01 NA02
NOON	NAT	R10	A	classe 1	≥ 0,36	-	NN01 NN02 NN03 NN04 NN05
NOON	GP	R11	A+B+C	classe 3	≥ 0,36	≥ 0,36	NN01 NN02 NN03 NN04 NN05
NOON EVO 2/E™ - 20 mm	RD	R11	A+B	classe 3	≥ 0,36	≥ 0,36	NN01 NN02 NN03
NORR	NAT	R10	A	classe 2	≥ 0,36	-	RR01 RR02 RR03 RR04 RR05 RR06 RR08 RR09
NORR	ST	R11	A+B+C	classe 3	≥ 0,36	-	RR01 RR02 RR03 RR04 RR05
NORR EVO 2/E™ - 20 mm	ST	R11	A+B+C	classe 3	≥ 0,36	-	RR01 RR02 RR03 RR05 RR06 RR08 RR09
NOVEMBER	NAT	R10	A+B	classe 2	≥ 0,36	≥ 0,36	NM01 NM02 NM03 NM04 NM05
NOVEMBER EVO 2/E™ - 20 mm	ST	R11	A+B+C	classe 3	≥ 0,36	≥ 0,36	NM01 NM02 NM04 NM05
OFFICINE EVO 2/E™ - 20 mm	ST	R11	A+B	classe 3	≥ 0,36	-	OF01 OF02 OF03 OF04 OF05
QUARZITI 2.0	NAT	R10	A+B	classe 2	≥ 0,36	≥ 0,36	QR01 QR02 QR03 QR04 QR05
QUARZITI 2.0	NAT R12	R12	A+B+C	classe 3	≥ 0,36	≥ 0,36	QR01 QR02 QR03 QR04 QR05
QUARZITI 2.0 EVO 2/E™ - 20 mm / 30 mm	NAT	R11	A+B	classe 3	≥ 0,36	≥ 0,36	QR01 QR02 QR03 QR04 QR05
RAIL	RD	R11	A+B+C	classe 3	≥ 0,36	≥ 0,36	RL01 RL02
SILVERLAKE	NAT	R10	A+B	classe 2	≥ 0,36	≥ 0,36	SK01 SK02 SK03 SK04 SK05 SK06
SILVERLAKE	ST	R11	A+B+C	classe 3	≥ 0,36	≥ 0,36	SK01 SK02 SK03 SK04 SK05 SK06
SILVERLAKE EVO 2/E™ - 20 mm	ST	R11	A+B+C	classe 3	≥ 0,36	≥ 0,36	SK01 SK02 SK03 SK04 SK05 SK06
MÖTLEY	NAT	R10	A+B	classe 1	≥ 0,36	≥ 0,36	MT01 MT02 MT03 MT04 MT05 MT06 MT07 MT08
MÖTLEY	ST	R11	A+B+C	classe 3	≥ 0,36	≥ 0,36	MT01 MT02 MT03 MT04 MT05 MT06
MÖTLEY EVO 2/E™ - 20 mm	ST	R11	A+B+C	classe 3	≥ 0,36	≥ 0,36	MT02 MT03 MT04 MT05 MT06
NYUMA	NAT	R10	A+B	classe 1	≥ 0,36	≥ 0,36	NY01 NY02 NY03 NY04 NY05 NY06
NYUMA	ST	R11	A+B+C	classe 3	≥ 0,36	≥ 0,36	NY01 NY02 NY03 NY04 NY05 NY06
NYUMA EVO 2/E™ - 20 mm	ST	R11	A+B+C	classe 3	≥ 0,36	≥ 0,36	NY01 NY02 NY03 NY04 NY05 NY06
ODUH	GP	R11	A+B+C	classe 3	≥ 0,36	≥ 0,36	NY01 NY02 NY03 NY04 NY05 NY06
ODUH EVO 2/E™ - 20 mm	RD	R11	A+B+C				NY01 NY02 NY03 NY04 NY05 NY06
VICEVERSA	NAT	R10	A+B	classe 1	≥ 0,36	≥ 0,36	VV01 VV02 VV03 VV04 VV05 VV06 VV07 VV08
VICEVERSA	ST	R11	A+B+C	classe 3	≥ 0,36	≥ 0,36	VV01 VV02 VV03 VV04 VV05 VV06 VV07 VV08

ACCORDIMENTI GENERALI PER LA MOVIMENTAZIONE, TAGLIO E POSA

General indications for handling, cutting and laying | Allgemeine Hinweise zu Handhabung und Transport | Consignes générales pour la manutention, la coupe et la pose | Disposiciones generales para el transporte, corte y colocación | Общие правила по перемещению, резке и укладке

MOVIMENTAZIONE HANDLING - HANDHABUNG UND TRANSPORT - MANUTENTION - TRANSPORTE - ПЕРЕМЕЩЕНИЕ



Ove possibile si consiglia l'utilizzo di elevatori meccanici per la consegna al piano delle lastre.

- EN Where possible, mechanical lifting systems should be used for delivering slabs above the ground floor.
- DE Wann immer möglich, empfehlen wir die Verwendung von mechanischen Hebezeugen für das Anheben und die Beförderung der Platten auf die jeweilige Etage.
- FR Lorsque cela est possible, il est conseillé d'utiliser des monte-charges mécaniques pour la livraison du carrelage à l'étage.
- ES Cuando es posible, se recomienda utilizar elevadores mecánicos para llevar las placas a la planta correspondiente.
- RU По возможности рекомендуется применение механических подъемников для доставки плит на этажи.



Per facilitare la movimentazione di lastre con superfici strutturate si consiglia l'utilizzo di ventose idonee.

- EN To facilitate handling of slabs with textured surfaces, the appropriate suction cups should be used.
- DE Um die Handhabung von Platten mit strukturierten Oberflächen zu erleichtern, wird die Verwendung von geeigneten Saughebern empfohlen.
- FR Afin de faciliter la manutention des plaques à surface structurée il est conseillé d'utiliser des ventouses adaptées.
- ES Para facilitar la manipulación de placas con superficies estructuradas se recomienda utilizar ventosas adecuadas.
- RU Чтобы облегчить перемещение плит со структурированной поверхностью, рекомендуется использовать соответствующие присоски.



La movimentazione al piano può essere gestita con l'aiuto di un telaio provvisto di ventose per conferire una maggiore stabilità alla lastra.

- EN Handling the slabs on the floor can be managed with the aid of a frame fitted with suction cups to make the slabs more stable.
- DE Das Anheben und die Beförderung auf die Etage kann mit Hilfe eines Rahmens mit Saugnapfen erfolgen, um so den Platten mehr Stabilität zu verleihen.
- FR La manutention à l'étage peut s'effectuer avec un châssis équipé de ventouses pour assurer une plus grande stabilité de la plaque.
- ES El trasporte en la planta puede realizarse con un bastidor dotado de ventosas, para dar una mayor estabilidad y evitar deformaciones de la placa.
- RU При подъеме плит на этажи для большей стабильности можно использовать раму с присосками.



Eventualmente si possono utilizzare apposite ventose idonee per la movimentazione manuale.

- EN The appropriate suction cups may be used for manual handling.
- DE Unter Umständen können auch geeignete Saugheber für die manuelle Handhabung verwendet werden.
- FR Si nécessaire, il est possible d'utiliser des ventouses spécialement conçues pour la manutention manuelle.
- ES También es posible utilizar ventosas específicas para la manipulación manual.
- RU При необходимости можно использовать соответствующие присоски для перемещения плит вручную.



Per spostamenti in ampie superfici è anche possibile utilizzare un carrello per il trasporto delle lastre.

- EN For moving the slabs over large surfaces, a forklift can be used.
- DE Bei großen Flächen kann auch ein Wagen für den Plattentransport verwendet werden.
- FR Pour les déplacements sur grandes surfaces, il est également possible d'utiliser un chariot pour le transport des plaques.
- ES Para el desplazamiento en una superficie extensa, también es posible utilizar un carro para el transporte de placas.
- RU При перемещении на большое расстояние можно также воспользоваться автогрузчиком для перевозки плит.

ACCORGIMENTI GENERALI PER LA MOVIMENTAZIONE, TAGLIO E POSA

General indications for handling, cutting and laying | Allgemeine Hinweise zu Handhabung und Transport | Consignes générales pour la manutention, la coupe et la pose | Disposiciones generales para el transporte, corte y colocación | Общие правила по перемещению, резке и укладке

TAGLIO CUTTING - ZUSCHNITT - COUPE - CORTE - РЕЗКА



Si raccomanda di effettuare le operazioni di taglio sopra ad un piano perfettamente stabile e planare.

- EN Cutting operations should be carried out on a perfectly stable, flat surface.
- DE Es wird empfohlen, den Zuschchnitt auf einer vollkommen ebenen und stabilen Oberfläche vorzunehmen.
- FR Il est recommandé d'effectuer les opérations de découpe sur un plan de travail parfaitement stable et plat.
- ES Se recomienda realizar los cortes sobre una superficie perfectamente estable y plana.
- RU Рекомендуется выполнять операции обрезки на ровной и устойчивой рабочей поверхности.



Si consiglia l'utilizzo di una guida di taglio provvista di utensile con la punta diamantata.

- EN A cutting guide fitted with a diamond tip tool is recommended.
- DE Es wird die Verwendung einer Schneidführung mit einem Werkzeug mit Diamantspitze empfohlen.
- FR Il est conseillé d'utiliser un guide coupe équipé d'un outil à pointe diamantée.
- ES Se recomienda utilizar una guía de corte dotada de broca diamantada.
- RU При обрезке рекомендуется пользоваться направляющей, оснащенной алмазным резак.



Per ottenere il taglio, evitando la rottura del materiale, si consiglia l'utilizzo di apposite pinze troncatrici.

- EN To cut the slab without breaking the material, the appropriate shears should be used.
- DE Für den Zuschchnitt wird die Verwendung einer speziellen Schneidzange empfohlen, um den Bruch des Materials zu verhindern.
- FR Pour effectuer la coupe sans briser le matériel, utiliser des cisailles adaptées.
- ES Para realizar el corte, sin romper el material, es aconsejable utilizar las pinzas cortadoras correspondientes.
- RU Для обрезки, во избежание раскалывания плит, рекомендуется пользоваться специальными отрезными клещами.



Per la posa dei materiali, si raccomanda il taglio a umido, o in alternativa l'uso di taglierina manuale. Non effettuare taglio a secco con utensili elettrici. Modalità di taglio non corrette possono infatti esporre il posatore a polveri di silice nocive per la salute.

- EN It is recommended to use wet cutting techniques or a manual cutter when laying materials. Do not use power tools for dry cutting. Incorrect cutting methods can release harmful silica dust and put the installer's health at risk.
- DE Für das Verlegen der Materialien empfiehlt sich das nasse Schneiden oder als Alternative die Verwendung eines manuellen Fliesenschneiders. Keine Trockenschnitte mit elektrischen Werkzeugen ausführen. Bei falschen Schneidmethoden könnte der Fliesenleger gesundheitsschädlichen Siliciumdioxidstäuben ausgesetzt werden.
- FR Pour la pose des matériaux, une coupe à l'eau ou, en alternative, l'utilisation d'une coupeuse manuelle sont recommandées. Ne pas effectuer de coupe à sec à l'aide d'outils électriques. Des modalités de coupe incorrectes peuvent, en effet, exposer le poseur à des poussières de silice nocives pour sa santé.
- ES Para la colocación de los materiales, se recomienda realizar el corte en húmedo o, como alternativa, utilizar una cortadora manual. No realizar el corte en seco con herramientas eléctricas. Métodos de corte incorrectos pueden exponer al alcañador/solador a polvo de silice nocivo para la salud.
- RU При укладке материалов рекомендуется резка с водяным охлаждением или же применение ручного плиткореза. Не выполняйте сухую резку с использованием электрических инструментов. Ненадлежащие способы резки могут подвергать укладчиков плитки воздействию вредной для здоровья кремниевой пыли.



Per tagli a L o interni alla lastra si raccomanda la realizzazione di fori in corrispondenza dei vertici per evitare che la superficie si danneggi con la lama del flessibile.

- EN For L-shaped cuts or cuts inside the slab, holes should be bored at the vertices to prevent the blade of the cutting disk damaging the surface.
- DE Für L-förmige Zuschnitte der Platte wird empfohlen, zunächst Löcher an den Eckpunkten anzubringen, um zu verhindern, dass die Oberfläche durch die Klinge des Trennschleifers beschädigt wird.
- FR Pour des coupes à angle droit ou internes, il est recommandé de percer des trous au droit de la plaque pour éviter d'endommager sa surface avec la lame de l'instrument.
- ES Para cortes en L o en el interior de la placa, es recomendable hacer taladros en correspondencia de los vértices, para evitar que la superficie se dañe con el disco de la amoladora angular.
- RU При выполнении фигурной обрезки или внутренних прорезей, рекомендуется сделать отверстия в точках, соответствующих верхним углам, во избежание повреждения поверхности плит гибким резак.



Per realizzare fori circolari sulle lastre si raccomanda di utilizzare una fresa diamantata con il diametro desiderato e di bagnare costantemente al superficie.

- EN To bore cylindrical holes on the slabs, a diamond cutting tool of the desired diameter should be used, and the surface should be kept wet constantly.
- DE Um zylindrische Bohrungen an der Platte anzubringen, wird die Verwendung einer Diamantfräse mit dem gewünschten Durchmesser empfohlen, dabei sollte die Oberfläche konstant mit Wasser benetzt werden.
- FR Pour percer des trous circulaires sur les plaques, utiliser une fraise diamantée au diamètre voulu et en humidifier constamment la surface.
- ES Para hacer perforaciones redondas en las placas es aconsejable utilizar una corona diamantada con el diámetro deseado y mojar constantemente la superficie.
- RU Для выполнения цилиндрических отверстий в плитах, рекомендуется использовать алмазную фрезу требуемого диаметра, обеспечивая постоянное увлажнение поверхности.

POSA LAYING - VERLEGUNG - POSE - COLOCACIÓN - УКЛАДКА



E' fondamentale verificare la planarità, la differenza massima consentita è di 1 mm ogni 2 metri.

- EN It is essential to check warpage; the maximum tolerance permitted is 1 mm every 2 metres.
- DE Es ist von grundlegender Wichtigkeit, die Planheit sicherzustellen, die Toleranzgrenze für den Höhenunterschied beträgt 1 mm alle 2 Meter.
- FR Il est essentiel de vérifier la planéité, la différence de niveau maximale consentie étant de 1 mm tous les 2 mètres.
- ES Es fundamental comprobar la planicidad, la diferencia máxima admitida es de 1 mm cada 2 metros.
- RU Необходимо проверить планштность поверхности: максимальный допуск составляет 1 мм на каждые 2 метра.



Si raccomanda l'applicazione della colla con doppia spalmatura. La prima, sulla lastra da posare, deve essere parallela al lato corto. Mentre la seconda, nella stessa direzione, deve essere applicata al massetto.

- EN A double layer of glue is recommended. The first, on the slab to be laid, must be parallel to the short side, while the second must be applied to the base, and spread in the same direction.
- DE Die Anwendung von Kleber mit doppelter Kleberschicht wird empfohlen. Die erste Klebeschicht wird auf der zu verlegenden Platte aufgetragen und muss parallel zur kurzen Seite aufgebracht werden. Die zweite Klebeschicht, in derselben Richtung, muss auf den Estrich aufgetragen werden.
- FR Il est recommandé d'appliquer de la colle à double encollage. Le premier, sur le carreau à poser, doit être parallèle au côté court. Le second, effectué dans le même sens, doit être appliqué sur la chape.
- ES Se recomienda la aplicación del mortero adhesivo por doble encolado. La primera capa se aplica directamente en la placa de forma paralela al lado corto. Mientras que la segunda capa, en la misma dirección, se extiende sobre la superficie de colocación.
- RU Рекомендуется выполнять двойную намазку клея: первую - на укладываемую плитку параллельно короткой стороне, а вторую, в том же направлении, на основу.



Per evitare che le lastre si scheggino durante la fase di posa si consiglia l'uso di un apposito dispositivo per l'accostamento delle lastre.

- EN To avoid the slabs being chipped during laying, an appropriate device should be used for placing the slabs next to one another.
- DE Um ein Absplittern der Platten während des Verlegens zu verhindern, wird die Verwendung einer speziellen Vorrichtung für den Anschluss der Platten empfohlen.
- FR Pour éviter que les plaques ne se brisent durant la phase de pose, il est conseillé d'avoir recours à un dispositif approprié pour les aligner bord à bord.
- ES Para evitar que las placas se astillen durante las operaciones de colocación, se recomienda utilizar un dispositivo especial para acercar las placas.
- RU Во избежание раскалывания плит во время укладки рекомендуется пользоваться специальным устройством для укладывания плит.



È necessario l'utilizzo di sistemi di livellatura per rendere perfetta la planarità della superficie posata.

- EN Levelling systems are recommended to ensure the surface laid is perfectly level.
- DE Die Verwendung von Nivelliersystemen wird empfohlen, um eine perfekte Planheit der verlegten Oberfläche sicherzustellen.
- FR Utiliser un système de nivellement pour garantir une planéité parfaite de la surface posée.
- ES Se recomienda utilizar sistemas de nivelación para que la superficie quede perfectamente plana.
- RU Рекомендуется использовать специальную систему выравнивающих распорок для обеспечения идеальной плоской поверхности.



Una volta adagiata la lastra, per eliminare completamente eccessi di aria, è necessario effettuare una battitura, manuale o meccanica, con l'apposito frattazzo antirimbalo, procedendo dal centro verso i lati esterni.

- EN Once the slab is in position, excess air should be removed completely by tapping it either manually or mechanically using the appropriate trowel, starting from the centre and moving out towards the sides.
- DE Sobald die Platte abgelegt wurde muss, um überschüssige Luft austreten zu lassen, ein Anklopfen erfolgen. Dies kann entweder von Hand oder mechanisch mit einem Putzbrettchen mit Rückprallschutz erfolgen, dabei muss von der Mitte nach Außen vorgegangen werden.
- FR Après la pose, pour éliminer totalement l'air emprisonné sous le carreau, le frapper, manuellement ou mécaniquement, avec une taloche anti-rebond prévue à cet effet, en procédant du centre vers les bords.
- ES Una vez acomodada la placa, para eliminar por completo el exceso de aire, hay que golpear la superficie, de forma manual o mecánica, con una llana antirrebote, procediendo del centro hacia los lados.
- RU После того как плитка будет уложена на основу, для удаления лишнего воздуха необходимо постучать по плитке специальной киянкой без отскока, ручной или механической, в направлении от центра к внешним краям.

BIG SIZES

6 MM

Mirage® **raccomanda l'utilizzo a pavimento di lastre in spessore 6 mm per le sole applicazioni in ambito residenziale, commerciale a traffico leggero e comunque in contesti ove non vi sia passaggio di carichi puntuali pesanti o transito di carrelli a ruote dure.**

Le lastre a 6mm, grazie al loro spessore ridotto, sono particolarmente indicate per la posa su pavimenti o rivestimenti preesistenti in marmo, pietra naturale, ceramica, senza la necessità di demolire la pavimentazione sottostante. Tale pavimentazione preesistente dovrà però essere planare, stabile, rigida e priva di rotture. In tutti questi casi sarà necessario valutare attentamente, assieme al progettista della pavimentazione, l'idoneità del sottofondo. In caso di dubbio sarà necessario valutare la necessità della demolizione e/o l'utilizzo di spessori tradizionali

La posa a pavimento su massetto di lastre in 6mm è invece fortemente condizionata dall'esecuzione ottimale dello stesso, dalla sua completa stagionatura, dal rispetto degli opportuni giunti di dilatazione nonchè dalla posa a regola d'arte. Pertanto, in questi casi, per maggiore precauzione, Mirage® suggerisce l'utilizzo del gres porcellanato in spessore tradizionale.

In generale, per l'applicazione a pavimento delle lastre in spessore 6mm, l'adesivo (da scegliere insieme al progettista in base alle caratteristiche del cantiere) dovrà essere applicato secondo il metodo della doppia spalmatura, al fine di assicurare la perfetta distribuzione dello stesso e di garantire un'adesione ottimale, evitando la formazione di eventuali vuoti che potrebbero essere causa di rotture.

ACCORGIMENTI SPECIFICI PER L'APPLICAZIONE DELLE GRANDI LASTRE IN 6 MM DI SPESSORE.

PRECAUTIONS FOR 6MM BIG SLABS APPLICATIONS.

SPEZIFISCHE HINWEISE FÜR DIE VERLEGUNG VON 6 MM STARKEN PLATTEN ALS BODENBELAG.

PRÉCAUTIONS NÉCESSAIRES POUR L'APPLICATION AU SOL DE PLAQUES DE 6 MM D'ÉPAISSEUR.

PROCEDIMIENTOS ESPECÍFICOS PARA LA APLICACIÓN COMO PAVIMENTO DE PLACAS DE 6 MM DE ESPESOR.

EN Mirage® stresses that slabs 6 mm in thickness may only be used as flooring in residential and commercial environments that are subject to light traffic, and furthermore, in contexts where there is no circulation of heavy loads or hard-tyre trolleys.

Thanks to the reduced thickness, the 6 mm slabs are a good solution for laying over pre-existing floors or tiling in marble, natural stone or ceramics, and avoid the necessity of demolishing the underlying floor. Such pre-existing flooring must, however, be even, stable, rigid and without breakages. Even if the floor conforms to all the above conditions, it is still necessary, together with the flooring project manager, to evaluate the suitability of the underlying layer. If there are any doubts, the need for demolition and/or the use of traditional thickness must be evaluated.

Successful laying of 6 mm slabs on a screed depends greatly on the skill with which it is laid, on its being left to cure completely and on the careful calculation of the appropriated junctures for dilation as well as being laid with due expertise. As a result, in these cases, Mirage® recommends the use of a traditional thickness porcelain stoneware.

In general, when laying a floor of 6 mm thick slabs, the adhesive (to be selected together with the project manager based on the characteristics of the construction) must be applied using the double bonding technique, aimed at ensuring the perfect distribution of the adhesive to guarantee the best bond, avoiding the presence of any hollows that could cause breakages.

In general, for the application a pavement of slabs in 6mm thickness, the adhesive (to be chosen together with the project manager on the basis of the characteristics of the site) must be applied according to the double spreading method, in order to ensure the perfect distribution of the same and to guarantee an optimal adhesion, avoiding the formation of any voids that could be the cause of breakages.

FR Mirage® recommande l'utilisation au sol de plaques de 6 mm d'épaisseur uniquement pour des applications dans un contexte résidentiel et commercial à faible affluence ainsi que dans des contextes dépourvus de passages de charges ponctuelles lourdes ou de chariots à roues dures.

Les plaques de 6 mm d'épaisseur, grâce à leur épaisseur réduite, sont particulièrement adaptées à une pose sur des sols ou des revêtements préexistants en marbre, en pierre naturelle et en céramique, sans impliquer la démolition de la sous-couche. Cette sous-couche préexistante devra toutefois être plane, stable, rigide et privée de ruptures. Il sera dans tous les cas nécessaire d'évaluer attentivement, avec le concepteur du sol, la conformité de la sous-couche. En cas de doute, il sera nécessaire d'évaluer la nécessité de la démolition et/ou l'utilisation d'épaisseurs traditionnelles.

La pose au sol de plaques de 6 mm sur un fond est, au contraire, fortement conditionnée par l'exécution optimale de celui-ci, par son séchage complet, par le respect des joints de dilatation adaptés ainsi que par la pose à effectuer dans les règles de l'art. Ainsi, dans ce cas, pour plus de précaution, Mirage® suggère l'utilisation du grès cérame dans une épaisseur traditionnelle.

En général, pour l'application au sol des plaques de 6 mm d'épaisseur, l'adhésif (à choisir avec le concepteur en fonction des caractéristiques du chantier) devra être appliqué suivant la méthode du double encollage afin de garantir non seulement la répartition parfaite de ce dernier mais aussi une adhérence optimale, en évitant ainsi la formation de vides éventuels qui pourrait provoquer des ruptures.

DE Mirage® empfiehlt die Verwendung von Platten mit Stärke 6 mm als Bodenbelag nur für Anwendungen im Privatbereich und in Gewerbe- und Objektbereichen mit geringer Trittbelastung, oder in Bereichen, in denen zumindest keine Rollwagen mit harten Rädern zum Einsatz kommen oder schwere punktuelle Belastungen auftreten.

Die 6 mm starken Platten eignen sich aufgrund ihrer geringen Stärke besonders für die Verlegung auf bestehenden Bodenbelägen oder Wandverkleidungen aus Marmor, Naturstein, Keramik, ohne dass der darunterliegende Belag zuvor entfernt werden muss. Dieser bereits vorhandene Boden muss jedoch eben, stabil, hart und bruchsicher sein. In all diesen Fällen muss die Eignung des Untergrundes gemeinsam mit dem Architekten oder Planer zuvor sorgfältig geprüft werden. Im Zweifelsfall muss die Notwendigkeit einer Entfernung des bestehenden Bodenbelags und/oder die Verwendung herkömmlicher Stärken in Erwägung gezogen werden.

Die Verlegung von 6 mm starken Platten auf Estrich hängt besonders von der optimalen Ausführung des Estrichs selbst, von seiner vollständigen Reifung, der Beachtung der entsprechenden Ausdehnungsfugen sowie der nach den Regeln der Kunst ausgeführten Verlegung ab. Daher empfiehlt Mirage® in diesen Fällen die Verwendung von Feinsteinzeug mit herkömmlicher Stärke.

Im Allgemeinen muss bei der Verlegung von 6 mm starken Platten als Bodenbelag der Klebstoff (der zusammen mit dem Planer nach den Eigenschaften des Verwendungsorts ausgewählt wird) doppelt aufgetragen werden (sowohl auf dem Untergrund als auch auf der Rückseite der Platte), um eine perfekte Verteilung und eine optimale Haftung zu gewährleisten und die Bildung von Hohlräumen zu vermeiden, die zu Bruch führen könnten.

ES Mirage® recomienda la utilización como pavimento de las placas de 6 mm de espesor solo para aplicaciones en ámbito residencial, en ambientes comerciales con tránsito reducido y, en cualquier caso, en contextos sin el paso de cargas pesadas localizadas o tránsito de carretillas con ruedas duras.

Gracias a su reducido espesor, las placas de 6 mm están especialmente indicadas para la colocación sobre pavimentos o revestimientos preexistentes de mármol, piedra natural o cerámica, sin necesidad de demoler la pavimentación sobre la que se apoya. La pavimentación preexistente deberá ser, de cualquier modo, plana, estable, rígida y sin roturas. En todos estos casos, deberá analizarse atentamente, junto con el proyectista de la pavimentación, si la base es adecuada. En caso de dudas, habrá que considerar si es necesaria la demolición y/o la utilización de espesores tradicionales.

La colocación como pavimento sobre solera de las placas de 6 mm dependerá en gran medida de la óptima ejecución de la misma, de su completo curado, de que se respeten las juntas de dilatación necesarias, así como de una colocación adecuada. Para mayor precaución en estos casos, Mirage® sugiere la utilización del gres porcelánico de espesor tradicional.

En general, para la aplicación como pavimento de las placas de 6 mm espesor, el adhesivo (a elegir junto con el proyectista según las características del lugar de la obra) deberá utilizarse con la técnica del doble encolado, con el fin de garantizar la distribución perfecta del mismo y una óptima adherencia, evitando que se formen posibles vacíos que pudieran ocasionar roturas.

RACCOMANDAZIONI PER UTILIZZO E CURA DELLE LASTRE COUNTERTOPS IN FORMATO 1620X3240X12

How to use and take good care of the COUNTERTOPS slabs in the 1200x2400x20 and 1620x3240x12 sizes | Tipps für den Einsatz und die Pflege der Platten COUNTERTOPS im Format 1200x2400x20 und 1620x3240x12 | Recommandations pour l'utilisation et le soin des plaques COUNTERTOPS dans le format 1200x2400x20 et 1620x3240x12 | Recomendaciones para el uso y cuidado de las placas COUNTERTOPS de formato 1200x2400x20 y 1620x3240x12 | Рекомендации по использованию и уходу за плитami COUNTERTOPS в форматах 1200x2400x20 и 1620x3240x12 | 1200x2400x20和1620x3240x12规格的COUNTERTOPS系列陶瓷板的使用和护理建议

IT

IT
Mirage non si ritiene in alcun modo responsabile per un utilizzo improprio delle proprie lastre.

Raccomandiamo il rispetto delle seguenti indicazioni, per evitare l'insorgenza di problematiche o danni accidentali:

- Prevenire gli urti accidentali sia in corrispondenza di spigoli e bordi (indipendentemente dalla tipologia di finitura scelta) sia sulla superficie del piano di lavoro;
- Evitare carichi puntuali particolarmente pesanti sul piano di lavoro, soprattutto in corrispondenza di eventuali parti a sbalzo. Nello specifico si raccomanda di non salire in piedi per nessun motivo sul piano, per evitare di concentrare il peso di una persona in una superficie limitata;
- Non impiegare abrasivi in genere come strumenti di pulizia del piano di lavoro;
- Non utilizzare coltelli di ceramica direttamente sul piano. Si sconsiglia anche l'utilizzo di coltelli in acciaio a diretto contatto del piano, soprattutto nel caso in cui la finitura sia in superficie Lucida;
- È raccomandato l'utilizzo di taglieri, soprattutto nel caso in cui il piano di lavoro scelto sia in superficie Lucida;
- È consigliabile utilizzare sottopentole per evitare il contatto diretto con oggetti caldi (es. pentole, caffettiere, etc);
- Si raccomanda di evitare tempi di contatto prolungati tra la superficie del piano di lavoro e prodotti di pulizia ad alta concentrazione (sia con ph molto bassi che molto alti). Questa avvertenza è da ritenersi valida in generale e ancor maggiormente nel caso in cui si sia scelto un piano con finitura superficiale Lucida;

Nel caso in cui si verificino graffi superficiali, indipendentemente dal tipo di superficie installata, si raccomanda di contattare Mirage per valutare la procedura di riparazione appropriata.

Si sottolinea nuovamente che Mirage non potrà essere ritenuta responsabile per danni o difettologie insorte a seguito del mancato rispetto di quanto sopra riportato e di quanto spiegato

[EN]

Mirage may not be held in any way responsible for an improper use of its slabs.

The instructions below should be followed carefully to avoid problems or accidental damage:

- Prevent accidental impact both at the corners and edges (regardless of the type of finish chosen) and on the surface of the worktop;
 - Avoid placing particularly heaving weights on the worktop, especially on any protruding parts. - Specifically, do not stand on the worktop for any reason, to avoid concentrating the weight of a person on a limited surface;
 - Do not use abrasive cleaning instruments on the worktop;
 - Do not use ceramic knives directly on the top. The use of steel knives should also be avoided directly on the top, especially on tops with a Polished surface finish;
 - The use of chopping boards is recommended, especially on tops with a Polished surface finish;
- it is advisable to use pot stands to avoid direct contact with hot objects such as pans or coffee pots;
- Prolonged contact is to be avoided between the surface of the worktop and highly concentrated cleaning products (with either a very low or a very high pH). This warning is valid for tops in general, and especially for those with a Polished surface finish;

In the event of scratches on the surface, regardless of the surface type, contact Mirage to discuss appropriate repair. Please remember that Mirage may not be held liable for any damage or defects caused by failure to observe the points above and to follow the explanations in cleaning and maintenance section of the technical manual.

[DE]

Mirage übernimmt keinerlei Verantwortung für einen unsachgemäßen Einsatz der Platten der Firma.

Wir empfehlen, die folgenden Anweisungen einzuhalten, um zu vermeiden, dass Probleme oder irrtümliche Schäden auftreten:

- Irrtümliche Stöße sowohl gegen die Kanten und Ränder
- Unabhängig von der Art der gewählten Ausführung) als auch auf der Oberfläche der Arbeitsplatte vermeiden.
- Besonders schwere Punktlasten auf der Arbeitsplatte vermeiden, insbesondere auf eventuell überragenden Teilen. Im Spezifischen raten wir ausdrücklich davon ab, aus irgendeinem Grund auf die Platte zu steigen, um zu vermeiden, das Gewicht einer Person auf einer geringen Fläche zu konzentrieren.
- Allgemein keine scheuernden Mittel als Instrumente zur Reinigung

der Arbeitsplatte verwenden.

- Keine Keramikmesser direkt auf der Platte verwenden. Wir raten auch von der Verwendung von Stahlmessern direkt auf der Fläche ab, vor allem im Fall der glänzenden Oberfläche.

- Wir empfehlen die Verwendung von Schneidbrettern, vor allem im Fall, dass die gewählte Arbeitsplatte eine glänzende Oberfläche aufweist.

- Es empfiehlt sich, Topfuntersetzer zu verwenden, um den direkten Kontakt mit heißen Gegenständen zu vermeiden (z.B. Töpfe, Kaffeekannen etc.).

- Es empfiehlt sich, eine längere Einwirkzeit von hochkonzentrierten Reinigungsprodukten (sowohl mit sehr niedrigem als auch mit sehr hohem pH-Wert) auf der Oberfläche der Arbeitsplatte zu vermeiden. Dieser Warnhinweis gilt allgemein und vor allem im Fall, dass eine Platte mit glänzender Oberflächenausführung gewählt wurde. Sollten Kratzer auf der Oberfläche auftreten, wird unabhängig von der Art der installierten Oberfläche empfohlen, Mirage zu kontaktieren, um abzuwägen, welcher Reparaturvorgang angemessen ist.

Wir betonen erneut, dass Mirage nicht für Schäden oder Mängel zur Verantwortung gezogen werden kann, die infolge der Missachtung der vorangehenden Hinweise und der Beschreibungen im Abschnitt Reinigung und Wartung im technischen Handbuch auftreten.

[FR]

Mirage ne sera en aucun cas tenue pour responsable d'une utilisation incorrecte de ses plaques.

Il est recommandé de respecter les indications suivantes afin d'éviter l'apparition de problèmes ou de dommages accidentels :

- Prévenir les chocs accidentels aussi bien au niveau des arêtes et des bords (indépendamment de la typologie de finition choisie) que sur la surface du plan de travail ;
- Éviter les charges ponctuelles particulièrement lourdes sur le plan de travail, notamment au niveau d'éventuelles parties en porte-à-faux. Plus précisément, il est recommandé de ne pas se mettre debout sur le plan, et cela pour aucune raison, afin d'éviter de concentrer le poids d'une personne sur une surface limitée ;
- Ne pas utiliser d'abrasifs en général comme produits de nettoyage du plan de travail ;
- Ne pas utiliser de couteaux en céramique directement sur le plan. Il est également déconseillé d'utiliser des couteaux en acier en contact direct avec le plan, notamment dans le cas où le plan présenterait une finition superficielle brillante ;
- Éviter les charges ponctuelles particulièrement lourdes sur le plan de travail choisi présente une surface brillante ;
- Il est conseillé d'utiliser des dessous-de-plat afin d'éviter le contact direct avec des objets chauds (ex. casseroles, cafetières, etc.) ;
- Il est recommandé d'éviter des temps de contact prolongés entre la surface du plan de travail et des produits de nettoyage à haute concentration (aussi bien à pH très bas que très élevés). Cet avertissement doit être respecté en général et encore davantage dans le cas où le plan choisi présenterait une finition superficielle brillante.

En cas de rayures superficielles, indépendamment du type de surface installée, il est recommandé de contacter Mirage afin d'évaluer la procédure de réparation appropriée.

Il est précisé de nouveau que Mirage ne pourra être tenue pour responsable des dommages ou des défauts apparus suite à un non-respect des indications susmentionnées et du contenu du manuel technique à la section nettoyage et entretien.

[ES]

Mirage no se considera responsable en modo alguno por un uso inadecuado de sus placas.

Se recomienda cumplir con las siguientes indicaciones para evitar problemas o daños accidentales:

- Evite impactos accidentales tanto en las esquinas como en los cantos (independientemente del tipo de acabado elegido) y en la superficie de la encimera;
- Evite cargas puntuales muy pesadas sobre la encimera, especialmente en correspondencia de posibles partes salientes. Específicamente, se recomienda no subir por ningún motivo sobre la encimera, para evitar concentrar el peso de una persona en un área limitada;
- No utilice abrasivos en general como producto para limpiar la encimera;
- No utilice cuchillos de cerámica directamente en la encimera. También se recomienda no utilizar cuchillos de acero en contacto directo con la misma, especialmente cuando el acabado es Pulido;
- Se recomienda el uso de tablas de cortar, especialmente cuando

el acabado de la encimera elegida es Pulido;

- Se recomienda utilizar posa ollas para evitar el contacto directo con objetos calientes (por ejemplo, ollas, cafeteras, etc.);

- Se recomienda evitar tiempos de contacto prolongados entre la superficie de la encimera y productos de limpieza de alta concentración (tanto con un pH muy bajo como muy alto). Esta advertencia debe considerarse válida en general y más aún cuando se haya elegido una encimera con acabado Pulido;

Si se produjeran arañazos en la superficie, independientemente del tipo de superficie instalada, se recomienda ponerse en contacto con Mirage para evaluar el procedimiento de reparación adecuado. Cabe remarcar nuevamente que Mirage no podrá ser considerada responsable por daños o defectos que surjan como resultado del incumplimiento de lo antedicho y de las instrucciones dadas en la sección limpieza y mantenimiento del manual técnico.

[RU]

Компания Mirage не несет никакой ответственности за ненадлежащее использование плит.

Рекомендуем соблюдать следующие указания во избежание возникновения проблем или случайных повреждений:

- избегать случайных ударов по краям и углам (независимо от типа выбранной отделки), а также по поверхности столешницы;
- избегать значительных точечных нагрузок на столешницу, в особенности в ее выступающей части. В частности, категорически запрещается становиться ногами на столешницу во избежание воздействия веса человека на ограниченную площадь;
- не пользоваться абразивными средствами для очистки столешницы;
- не резать керамическими ножами непосредственно по поверхности столешницы. Также не рекомендуется непосредственный контакт стальных ножей с поверхностью, в особенности в случае отделки Lucida;
- рекомендуется пользоваться разделочными досками, в особенности в случае отделки Lucida;
- рекомендуется пользоваться подставками во избежание прямого контакта с горячими предметами (например, кастрюлями, кофеварками и пр.);
- не рекомендуется оставлять надолго на поверхности концентрированные чистящие средства (как с очень низким, так и с очень высоким pH). Этой рекомендации следует придерживаться в целом, и в особенности, в случае столешницы с отделкой Lucida;
- В случае образования поверхностных царапин, независимо от отделки установленной столешницы, рекомендуем обратиться в компанию Mirage для выбора соответствующей процедуры для их удаления.

Еще раз подчеркиваем, что компания Mirage не несет ответственности за повреждения или дефекты, возникшие в результате несоблюдения вышеуказанных рекомендаций, а также пояснений, приведенных в сборнике инструкций в разделе, посвященном уходу и содержанию.

[中國]

Mirage对由于不正当使用其陶瓷板所造成的损失不承担任何责任。

我们建议遵守以下说明，以避免出现问题或意外损坏：

- 防止角落和边缘（无论选择何种类型）以及工作表面上的意外撞击；
- 避免在工作台平面上施加格外重的点负荷，特别是在任何突出部件的附近。具体而言，建议不要出于任何原因站在工作台平面上，以避免将人体重量集中在有限的区域内；
- 切勿使用一般磨蚀性材料作为工作台表面的清洁工具；
- 切勿在工作台平面上直接使用陶瓷刀。也不建议在使用钢刀时直接接触工作平面，特别是光泽表面时；
- 建议使用砧板，特别是在所选工作台表面属于光泽表面的情况下；
- 建议使用三脚架避免直接接触热物体（如锅，咖啡壶等）；
- 建议避免工作台表面与高浓度清洁产品（无论pH值非常低或非常高）长时间接触。这一警告被普遍认为是有效的，特别在选择了具有光泽表面的工作台表面时更是如此；
- 如果出现表面划痕，无论安装的表面类型如何，建议联系Mirage公司以评估相应的维修程序。

我们再次强调，Mirage公司对因不遵守上述规定以及技术手册中的清洁和维护部分说明而导致的损坏或缺陷不承担任何责任。

TECHNICAL DATA AND CERTIFICATIONS

ACCORGIMENTI GENERALI PER LASTRE IN GRES PORCELLANATO MIRAGE MIROIR

General precautions for Mirage Miroir slabs in porcelain stoneware | Allgemeine Anweisungen für Mirage Feinsteinzeugplatten der Kollektion Miroir

Precautions generales pour les plaques en gres cerame Mirage Miroir | Recomendaciones generales para las placas de gres porcelánico Mirage Miroir

Общие рекомендации для плит из керамогранита Mirage Miroir

[IT]	[EN]	[DE]	[FR]	[ES]	[RU]
-------------	-------------	-------------	-------------	-------------	-------------

Le lastre specchianti Miroir sono lastre pregiate, realizzate su supporto in gres porcellanato Mirage e decorate con oro, platino e ulteriori applicazioni decorative che esaltano la profondità ed il pregio estetico dei soggetti.

La creazione delle lastre Miroir comporta lavorazioni complesse che, come tali, potrebbero causare piccoli imperfezioni superficiali, che rappresentano a tutti gli effetti una caratteristica intrinseca del prodotto.

Durante il trasporto e lo stoccaggio sono necessari alcuni accorgimenti, che riportiamo di seguito:

TRASPORTO DEL MATERIALE:

Durante il trasporto mantenere sempre le casse piane e stabili, per limitare lo scivolamento delle lastre.

Nelle operazioni di carico e scarico evitare che le lastre scorrano l’una sull’altra; si consiglia quindi una movimentazione tramite sollevatore a ventosa.

STOCCAGGIO DEL MATERIALE:

Una posizione errata o un luogo non idoneo durante lo stoccaggio possono produrre danni o segni superficiali alla lastra, a volte permanenti.

E’ importante quindi immagazzinare le lastre in locali chiusi che garantiscano condizioni climatiche standard, senza presenza di un eccessivo grado di umidità.

DOVE UTILIZZARE MIROIR:

La gamma Miroir è utilizzabile esclusivamente per applicazioni in interno e a rivestimento.

La gamma Miroir non è inoltre destinata ad ambienti bagno, al rivestimento di box doccia o comunque in aree dove alte temperature e/o vapore possano pregiudicare l’integrità della lastra.

ISTRUZIONI PER LA POSA:

• Per posare il materiale è possibile utilizzare una normale colla per gres porcellanato.

• Per non graffiare le lastre Miroir durante la fase di stuccatura, si raccomanda di non togliere la pellicola protettiva dalla lastra, ma di sollevarla esclusivamente in prossimità dei bordi. Rimuovere la pellicola protettiva solo a posa ultimata.

CURA E PULIZIA:

• Per la pulizia di Miroir possono essere utilizzati solo prodotti con Ph neutro (quali, a titolo esemplificativo ma non esaustivo, sapone di Marsiglia) e un panno morbido, senza parti ruvide o di metallo.

• Per pulizie più profonde è possibile utilizzare alcool puro al 95%.

• È assolutamente sconsigliato l’utilizzo di detersgenti con Ph acido o basico che potrebbero compromettere la natura estetica del materiale in modo permanente.

[IT]	[EN]	[DE]	[FR]	[ES]	[RU]
-------------	-------------	-------------	-------------	-------------	-------------

The mirrored Miroir slabs are high quality products, made on a Mirage porcelain stoneware support and decorated with gold, platinum and other decorative applications that highlight the depth and aesthetic value of the objects.

The creation of the Miroir slabs requires complex working processes that, as such, could cause small surface imperfections which, to all intents and purposes, are an intrinsic characteristic of the product.

A number of precautions are necessary during transport and storage, as set out below:

TRANSPORT OF THE MATERIAL:

During transport, always keep the boxes flat and stable in order prevent the slabs from sliding.

In loading and unloading operations, make sure the slabs don’t slide over one another; handling with a suction lifter is, therefore, recommended.

STORAGE OF THE MATERIAL:

A wrong position or an unsuitable location for storage could cause surface damage or marks on the slab, sometimes permanent.

It’s important, therefore, to store the slabs in closed locations that ensure standard climatic conditions, without an excessive level of humidity.

WHERE TO USE MIROIR:

The Miroir range is useable only for interior and wall applications.

The range is not suitable for bathroom environments, shower enclosure linings or, in any case, in areas where high temperatures and/or steam could affect the integrity of the slab.

INSTRUCTIONS FOR INSTALLATION:

• It’s possible to use a normal glue for porcelain stoneware to install the material.

• To avoid scratching the Miroir when grouting, it is recommended not to remove the slab’s protective film, but to lift it only near the edges, and remove the protective film only when the installation is completed.

CARE AND CLEANING:

• Only neutral pH products (such as, merely by way of example, Marseille soap) and a soft cloth without rough or metal parts are to be used for cleaning Miroir.

• 95% pure alcohol can be used for more thorough cleaning.

• it is strongly recommended not to use detergents with acid or alkaline pH that could permanently affect the aesthetic quality of the material.

[IT]	[EN]	[DE]	[FR]	[ES]	[RU]
-------------	-------------	-------------	-------------	-------------	-------------

Die Platten mit spiegelnder Oberfläche der Kollektion Miroir sind hochwertige Platten, die auf einem Scherben aus Mirage-Feinsteinzeug gefertigt und mit Gold, Platin und anderen dekorativen Applikationen verziert sind, die die Tiefe und die Ästhetik der Motive verbessern.

Die komplexe Herstellung der Platten der Kollektion Miroir kann zu kleinen Oberflächenfehlern führen kann, die jedoch ein wesentliches Merkmal des Produkts sind.

Während des Transports und der Lagerung sind einige Vorsichtsmaßnahmen erforderlich, die wir nachfolgend detailliert ausführen:

TRANSPORT DES MATERIALS

Halten Sie die Kisten während des Transports immer flach und stabil, um ein Verrutschen der Platten zu verhindern. Beim Be- und Entladen ist darauf zu achten, dass die Platten nicht übereinander geschoben werden; es empfiehlt sich daher, bei der Handhabung einen Saugheber zu verwenden.

LAGERUNG DES MATERIALS

Eine falsche Position oder ein ungeeigneter Ort während der Lagerung kann zu Beschädigungen oder Abdrücken auf der Platte führen, die manchmal dauerhaft sind.

Es ist daher wichtig, die Platten in geschlossenen Räumen zu lagern, die normale klimatische Bedingungen ohne übermäßige Feuchtigkeit gewährleisten.

WO DIE PLATTEN DER KOLLEKTION MIROIR ZUM EINSATZ KOMMEN KÖNNEN:

Die Kollektion kann nur für Wanderverkleidungen in Innenräumen verwendet werden.

Die Kollektion Miroir ist nicht für die Verwendung in Badezimmern, Duschkabinen oder anderen Bereichen vorgesehen, in denen hohe Temperaturen und/oder Wasserdampf die Platte beeinträchtigen können.

VERLEGEHINWEISE

• Zum Verlegen des Materials kann normaler Fliesenkleber für Feinsteinzeug verwendet werden.

• Um zu vermeiden, dass die Platten der Kollektion Miroir verkratzen, empfiehlt es sich, während der Verfugung die Schutzfolie nicht von der Platte zu entfernen, sondern sie nur im Randbereich anzuheben. Entfernen Sie die Schutzfolie erst nach der Verlegung vollständig.

PFLEGE UND REINIGUNG:

• Für die Reinigung der Platten der Kollektion Miroir dürfen nur Produkte mit einem neutralen pH-Wert verwendet werden (wie zum Beispiel z. B. Marseiller Seife) und ein weiches Tuch, das frei von scheuernden und metallischen Bestandteilen ist.

• Für eine gründlichere Reinigung kann 95%iger reiner Alkohol verwendet werden.

• Von der Verwendung von Reinigungsmitteln mit einem sauren oder basischen pH-Wert wird dringend abgeraten, denn sie könnten die Ästhetik des Materials dauerhaft beeinträchtigen.

[IT]	[EN]	[DE]	[FR]	[ES]	[RU]
-------------	-------------	-------------	-------------	-------------	-------------

Les plaques réfléchissantes Miroir sont des plaques précieuses, réalisées sur un support en grès cérame Mirage et décorées à l’or, au platine et à d’autres applications décoratives qui mettent en valeur la profondeur et la qualité esthétique des sujets.

La création des plaques Miroir comporte des façonnages complexes qui, comme tels, pourraient causer de petites imperfections de surface, qui constituent à part entière une caractéristique intrinsèque du produit.

Durant le transport et le stockage, certaines précautions sont nécessaires, que nous reportons ci-dessous :

TRANSPORT DU MATERIEL :

Durant le transport, toujours maintenir les caisses à plat et stables, pour limiter le glissement des plaques.

Au cours des opérations de chargement et de déchargement, éviter que les plaques se déplacent l’une sur l’autre ; il est alors conseillé de les déplacer au moyen d’un système de levage à ventouse.

STOCKAGE DU MATERIEL :

Une mauvaise position ou un lieu non adapté durant le stockage peuvent provoquer des dommages ou des marques superficielles sur la plaque, parfois permanents.

Il est donc important d’emmagasiner les plaques dans des locaux fermés qui garantissent des conditions climatiques standard, sans présence de niveau d’humidité excessif.

OU UTILISER MIROIR :

La gamme Miroir est utilisable exclusivement pour des applications en intérieur et en revêtement.

La gamme Miroir, en outre, n’est pas destinée à des salles de bains, au revêtement de cabine de douche ou en tout lieu où de hautes températures et/ou de la vapeur pourraient compromettre l’intégrité de la plaque.

INTRUCTIONS POUR LA POSE :

• Pour poser le matériel il est possible d’utiliser une colle normale pour grès cérame.

• Afin de pas rayer les plaques Miroir au cours de la phase de jointoiement, il est recommandé de ne pas retirer la pellicule de protection de la plaque, mais de la soulever exclusivement à proximité des bords. Retirer la pellicule de protection seulement la pose achevée.

ENTRETIEN ET NETTOYAGE :

• Pour le nettoyage de Miroir on peut utiliser seulement des produits au pH neutre

(comme, à titre d’exemple, mais non exhaustif, le savon de Marseille) et un chiffon doux, sans parties rêches ou de métal.

• Pour les nettoyages plus en profondeur il est possible d’utiliser de l’alcool pur à 95%.

• Il est absolument déconseillé d’utiliser des détergents au pH acide ou basique qui pourraient compromettre la nature esthétique du matériel de façon permanente.

[IT]	[EN]	[DE]	[FR]	[ES]	[RU]
-------------	-------------	-------------	-------------	-------------	-------------

Las placas espejadas Miroir son placas preciosas, realizadas sobre un soporte de gres porcelánico Mirage y decoradas con oro, platino y otras aplicaciones decorativas que exaltan la profundidad y el valor estético de los motivos.

Para la fabricación de las placas Miroir se utilizan procesos complejos que, como tales, pueden causar pequeñas imperfecciones en la superficie, que son a todos los efectos una característica intrínseca del producto.

Durante el transporte y el almacenamiento es necesario tomar algunas precauciones:

TRANSPORTE DEL MATERIAL:

Durante el posporte, mantenga siempre las cajas en plano y en posición estable, para limitar el deslizamiento de las placas.

Durante las operaciones de carga y descarga, evite que las placas se deslicen unas sobre otras, por lo que se recomienda utilizar un elevador con ventosas.

ALMACENAMIENTO DEL MATERIAL:

Una posición incorrecta o un lugar inadecuado durante el almacenamiento pueden provocar daños o marcas superficiales en la placa, a veces permanentes.

Por lo tanto, es importante almacenar las placas en lugares cerrados que garanticen condiciones climáticas estándares, sin excesiva humedad.

DÓNDE UTILIZAR MIROIR:

La gama Miroir se puede utilizar únicamente en interiores y como revestimiento.

La gama Miroir no ha sido diseñada para ser utilizada en baños, ni como revestimiento de cabinas de ducha, ni zonas donde las altas temperaturas y/o el vapor puedan afectar a la integridad de la placa.

INSTRUCCIONES PARA LA COLOCACIÓN:

• Para la colocación del material se puede utilizar un adhesivo normal para gres porcelánico.

• Durante el rejuntado, para no rayar las placas Miroir, se recomienda no quitar la película protectora de la placa, sino levantarla solo cerca de los bordes. Retire la película solo cuando se termine la colocación.

CUIDADO Y LIMPIEZA:

• Para la limpieza de Miroir se pueden utilizar solo productos con un pH neutro

(por ejemplo, a título meramente indicativo y no exhaustivo, jabón de Marsella) y un paño suave sin partes ásperas ni metálicas.

• Para una limpieza más profunda, se puede utilizar alcohol puro al 95%.

• No utilice detergentes con un pH ácido o básico, ya que podrían comprometer permanentemente la naturaleza estética del material.

[IT]	[EN]	[DE]	[FR]	[ES]	[RU]
-------------	-------------	-------------	-------------	-------------	-------------

Зеркальные плиты Miroir - это высокоценные плиты, с основой из керамического гранита Mirage и декором из золота, платины и других декоративных аппликаций, которые подчеркивают глубину и эстетическую ценность рисунка.

Создание плит Miroir требует сложных процессов изготовления, могущих вызывать незначительные поверхностные дефекты, которые, в любом случае, являются неотъемлемой характеристикой продукции.

Во время транспортировки и хранения необходимо соблюдать некоторые нижеприведенные рекомендации:

ТРАНСПОРТИРОВКА МАТЕРИАЛА:

При транспортировке необходимо постоянно следить за тем, чтобы ящики оставались в ровном положении и были надежно закреплены во избежание скольжения плит.

При выполнении погрузо-разгрузочных работ избежать скольжения одной плиты по поверхности другой; следовательно, рекомендуется использовать погрузочный механизм с вакуумными присосками.

ХРАНЕНИЕ МАТЕРИАЛА:

Неправильное положение или непригодное место при хранении может вызвать повреждение плит или оставить порою необратимые следы на поверхности.

Следовательно, важно складировать плиты в закрытых помещениях, гарантирующих стандартные климатические условия и отсутствие избыточной влаги.

ГДЕ ИСПОЛЬЗОВАТЬ ПЛИТЫ MIROIR:

Плиты серии Miroir следует использовать исключительно для внутренних работ и для облицовки стен.

Серия Miroir также не предназначена для отделки ванных комнат, душевых кабин или, в любом случае, зон, где повышенные температуры и/или пар могут повредить целостность плит.

ИНСТРУКЦИИ ПО УКЛАДКЕ:

• Для укладки материала можно применять обычный клей для керамического гранита.

• Во избежание царапин на плитах Miroir при нанесении затирки, рекомендуется не снимать защитную пленку, но лишь слегка приподнять ее по краям. Удалить защитную пленку только по окончании укладки.

УХОД И ОЧИСТКА:

• Для очистки плит Miroir можно применять только средства с нейтральным pH (например, такие, но не исключительно, как хозяйственное мыло) и мягкую ветошь, без шероховатых или металлических частей.

• Для более глубокой очистки можно использовать чистый 95%-ный спирт.

• Категорически не рекомендуется применять мощные средства с кислотным или щелочным pH, которые могут необратимо повредить эстетический вид материала.

ACCORGIMENTI GENERALI PER LASTRE IN GRES PORCELLANATO MIRAGE PAPIER

General precautions for Mirage Papier slabs in porcelain stoneware | Allgemeine Anweisungen für Mirage Feinsteinzeugplatten der Kollektion Papier
 Precautions generales pour les plaques en gres cerame Mirage Papier | Recomendaciones generales para las placas de gres porcelánico Mirage Papier
 Общие рекомендации для плит из керамогранита Mirage Papier

[IT]

DOVE UTILIZZARE PAPIER:

La gamma Papier è utilizzabile per applicazioni a rivestimento sia in interno che in esterno, in ambienti commerciali o residenziali, per rivestire box doccia o comunque in aree caratterizzate anche da alte temperature e/o vapore. I soggetti Jardin, Encanto, Palm, Camille, Nuages, Aquarelle Rose, Aquarelle Vert ed Aurora possono essere utilizzati anche in applicazione a pavimento. Per tutti i soggetti non menzionati, tale applicazione è fortemente sconsigliata, per evitare il danneggiamento del prodotto.

ISTRUZIONI PER LA POSA:

Per posare Papier è possibile utilizzare una tradizionale colla per gres porcellanato, seguendo le normali procedure e indicazioni per la posa sulla base del formato e della destinazione d'uso specifica.

CURA E PULIZIA:

Papier puo' essere pulita con i tradizionali prodotti destinati al gres porcellanato. Fanno eccezione i soggetti Merveille, Soleil, Corolle, Encanto Gold, Camille Gold, Camille Rose, Espoir Chaud e Espoir Froid realizzati con l'ausilio di applicazioni superficiali o materie prime selezionate. Per questi soggetti si sconsiglia l'utilizzo di qualsivoglia prodotto abrasivo in fase di posa o pulizia, che potrebbe danneggiare la superficie. Si consiglia quindi di eseguire la pulizia ordinaria esclusivamente con l'ausilio di un panno morbido e prodotti a Ph neutro, così da evitare opacizzazioni o graffiature (no acidi o basi).

[FR]

OÙ UTILISER PAPIER :

La gamme Papier est utilisable pour des applications murales, aussi bien à l'intérieur qu'à l'extérieur, dans des contextes commerciaux ou résidentiels, pour revêtir les cabines de douche ou des espaces caractérisés notamment par des températures élevées et/ou la présence de vapeur. Les sujets Jardin, Encanto, Palm, Camille, Nuages, Aquarelle Rose, Aquarelle Vert et Aurora peuvent être utilisés aussi dans le cadre d'une application au sol. Pour tous les sujets non mentionnés, ladite application est fortement déconseillée afin d'éviter l'endommagement du produit.

INSTRUCTIONS POUR LA POSE :

Pour poser Papier, il est possible d'utiliser une colle traditionnelle pour le grès cérame, en suivant les procédures normales et les indications pour la pose en fonction du format et de la destination d'emploi spécifique.

SOIN ET NETTOYAGE :

Papier peut être nettoyé avec des produits traditionnels destinés au grès cérame, contrairement aux sujets Merveille, Soleil, Corolle, Encanto Gold, Camille Gold, Camille Rose, Espoir Chaud et Espoir Froid qui sont réalisés avec des applications superficielles ou des matières premières sélectionnées. Pour ces sujets, l'utilisation de produits abrasifs est déconseillée en phase de pose ou de nettoyage car ceux-ci pourraient abîmer la surface. Il est donc recommandé d'effectuer un nettoyage ordinaire à l'aide d'un chiffon doux et de produits au Ph neutre uniquement, de manière à éviter les opacifications ou les rayures (pas d'acides ni de bases).

[EN]

WHERE PAPIER CAN BE USED:

The Papier range can be used for both indoor and outdoor walls, in commercial and residential settings, as well as to tile shower enclosures or other areas subject to high temperatures and steam. The Jardin, Encanto, Palm, Camille, Nuages, Aquarelle Rose, Aquarelle Vert and Aurora tiles can also be used on floors. We strongly advise against the use of all the other tiles not mentioned on floors, to avoid damaging the product.

LAYING INSTRUCTIONS:

PAPIER can be laid using a traditional glue for porcelain stoneware, following standard laying procedures and indications for the size selected and specific intended use.

CLEANING AND MAINTENANCE:

Papier can be cleaned using traditional products for porcelain stoneware, with the exception of Merveille, Soleil, Corolle, Encanto Gold, Camille Gold, Camille Rose, Espoir Chaud and Espoir Froid, created with surface applications or selected raw materials. For these tiles, we recommend avoiding the use of any kind of abrasive products during installation or for cleaning, to avoid damaging the surface. Ordinary cleaning should be carried out exclusively using a soft cloth and products with a neutral pH, to avoid dulling or scratching (no acids or bases).

[ES]

DÓNDE UTILIZAR PAPIER:

La gama Papier puede utilizarse como revestimiento tanto en interiores como en exteriores, en entornos comerciales o residenciales, para revestir cabinas de ducha o también en zonas que se caracterizan por altas temperaturas y/o vapor. Los motivos Jardin, Encanto, Palm, Camille, Nuages, Aquarelle Rose, Aquarelle Vert y Aurora también puede utilizarse como pavimento. Para todos los motivos que no se mencionan, se desaconseja encarecidamente su colocación en el suelo, para evitar que se dañe el producto.

INSTRUCCIONES PARA LA COLOCACIÓN:

Para la colocación de Papier se puede utilizar un adhesivo tradicional para gres porcelánico, siguiendo los procedimientos e instrucciones normales de colocación según el formato específico y el uso previsto.

CUIDADO Y LIMPIEZA:

Papier se puede limpiar con los productos tradicionales para el gres porcelánico. Quedan exceptuados los motivos Merveille, Soleil, Corolle, Encanto Gold, Camille Gold, Camille Rose, Espoir Chaud y Espoir Froid realizados con ayuda de aplicaciones superficiales o materias primas seleccionadas. Para estos motivos, desaconsejamos el uso de cualquier producto abrasivo durante la instalación o la limpieza, que podría dañar la superficie. Por lo tanto, recomendamos la limpieza ordinaria exclusivamente con un paño suave y productos de pH neutro para evitar que se opaque o se raye (sin ácidos ni bases).

[DE]

WO PAPIER EINGESETZT WERDEN KANN:

Das Sortiment Papier kann für Anwendungen als Verkleidung sowohl im Innen- als auch Außenbereich in Gewerbe- oder Wohnbereichen, zur Verkleidung von Duschkabinen oder allgemein in Bereichen, in denen auch hohe Temperaturen und/oder Dampf auftreten können, verwendet werden. Die Versionen Jardin, Encanto, Palm, Camille, Nuages, Aquarelle Rose, Aquarelle Vert und Aurora können auch als Bodenbelag angewendet werden. Bei allen nicht genannten Versionen wird von dieser Anwendung abgeraten, um eine Beschädigung des Produkts zu vermeiden.

VERLEGEANWEISUNGEN:

Zum Verlegen von Papier kann ein traditioneller Kleber für Feinsteinzeug unter Einhaltung der gewöhnlichen Vorgangsweisen und Verlegeanweisungen je nach Format und spezifischem Verwendungszweck verwendet werden.

PFLEGE UND REINIGUNG:

Papier kann mit den traditionellen Produkten für Feinsteinzeug gereinigt werden. Eine Ausnahme bilden die Versionen Merveille, Soleil, Corolle, Encanto Gold, Camille Gold, Camille Rose, Espoir Chaud und Espoir Froid, die mit der Hilfe von oberflächlichen Anwendungen oder ausgewählten Rohstoffen gefertigt werden. Bei diesen Versionen wird von der Verwendung scheuernder Produkte beim Verlegen oder der Reinigung abgeraten, da sie die Oberfläche beschädigen könnten. Es empfiehlt sich daher, die regelmäßige Reinigung ausschließlich mit einem weichen Tuch und Produkten mit neutralem pH-Wert auszuführen, um Trübungen oder Kratzer zu vermeiden (keine Säuren oder Laugen).

[中國]

在哪里使用PAPIER:

Papier 系列可用于室内和室外、商业或住宅环境中的墙面装修应用，用于淋浴房或其他高温和/或蒸汽区域的墙砖铺设。Jardin、Encanto、Palm、Camille、Nuages、Aquarelle Rose、Aquarelle Vert 和 Aurora 等图案主题也可用于地面装修应用。对于所有未提及的图案主题，强烈建议不要使用此应用，以免损坏产品。















铺设说明:

铺设 Papier 可以使用传统的瓷质砖胶水，根据规格和特定的预期用途，按照正常的程序和说明进行铺设。

护理和清洁:

Papier 系列可以使用瓷质砖专用的传统清洁产品进行清洁。Merveille、Soleil、Corolle、Encanto Gold、Camille Gold、Camille Rose、Espoir Chaud 和 Espoir Froid 等借助表面粘贴或精选原材料制成的图案主题除外。对于这些图案主题，我们不建议在安装或清洁过程中使用任何研磨性产品，这可能会损坏表面。因此，建议仅使用软布和PH值为中性的产品进行常规清洁，以避免令其变得哑暗或划痕（无酸或碱）。

STANDARD EN 14411 - G

	CARATTERISTICHE TECNICHE TECHNICAL DATA TECHNISCHE DATEN CARACTERISTIQUES TECHNIQUES CARACTERISTICAS TECNICAS ТЕХНИЧЕСКИЕ ХАРАКТЕРИСТИКИ 技术标准	NORMA STANDARD NORM NORME NORMA ЗНАЧЕНИЯ 标准	VALORI PRESCRITTI DALLE NORME EN 14411 - G INTERNATIONAL STANDARDS EN 14411 - G INTERNATIONALE NORMWERTE EN 14411 - G VALEURS PREVUES PAR LES NORMES EN 14411 - G VALORES PREVISTOS POR LAS NORMAS EN 14411 - G ПРЕДУСМОТРЕННЫЕ СТАНДАРТОМ EN 14411-G EN 14411 - G标准规定值	VALORE MEDIO MIRAGE MIRAGE AVERAGE VALUE MIRAGE MITTELWERT VALEURS MOYEN MIRAGE VALOR MEDIO MIRAGE СРЕДНЕЕ ЗНАЧЕНИЕ MIRAGE MIRAGE平均值		
	CARATTERISTICHE DIMENSIONALI - SIZE CHARACTERISTICS - MASSEIGENSCHAFTEN DETERMINATION DES CARACTERISTIQUES DIMENSIONELLES - CARACTERISTICAS DIMENSIONALES - РАЗМЕРНЫЕ ХАРАКТЕРИСТИКИ - 尺寸特征					
	LATI SIDES - SEITEN COTES - CANTOS РАЗМЕРЫ СТОРОН - 側邊	EN ISO 10545-2	± 0,3% MAX (± 1,0 mm MAX)	CONFORME COMPLYING		
	SPESSORE THICKNESS - DICKE ÉPAISSEUR - ESPESOR ТОЛЩИНА - 厚度	EN ISO 10545-2	± 5,0% MAX (± 0,5 mm MAX)	CONFORME COMPLYING		
	RETTILINEITÀ DEGLI SPIGOLI STRAIGHTNESS OF SIDES - GERADLINIGKEIT DER KANTEN RECTITUDE DES ARETES - RECTIDUD DE LOS CANTOS КОСОУГОЛЬНОСТЬ - 边角平直度	EN ISO 10545-2	± 0,3% MAX (± 0,8 mm MAX)	CONFORME COMPLYING		
	ORTOGONALITÀ RECTANGULARITY - RECHTWINKLIGKEIT PERPENDICULARITÉ - ORTOGONALIDAD КРИВИЗНА СТОРОН - 直角度	EN ISO 10545-2	± 0,3% MAX (± 1,5 mm MAX)	CONFORME COMPLYING		
	PLANARITÀ SURFACE FLATNESS - EBENFLÄCHIGKEIT PLANEITE DE SURFACE - PLANEIDAD КРИВИЗНА ЛИЦЕВОЙ ПОВЕРХНОСТИ - 平整度	EN ISO 10545-2	± 0,4% MAX (± 1,8 mm MAX)	CONFORME COMPLYING		
	ASSORBIMENTO D'ACQUA WATER ABSORPTION - WASSERAUFNAHME ABSORPTION D'EAU - ABSORCIÓN DE AGUA ВОДОПОГЛОЩЕНИЕ - 吸水率	EN ISO 10545-3	≤ 0,5%	≤ 0,05%		
	RESISTENZA ALLA FLESSIONE FLEXION RESISTANCE - BIEGEFESTIGKEIT RESISTANCE A LA FLEXION - RESISTENCIA A LA FLEXIÓN ПРЕДЕЛ ПРОЧНОСТИ ПРИ ИЗГИБЕ - 抗弯强度	EN ISO 10545-4	S ≥ 700 N (< 7,5 mm) S ≥ 1.300 N (> 7,5 mm) R ≥ 35 N/mm².	±6 mm: S≥1100N R≥45 N/mm² ±9 mm: S≥2.400N R≥48 N/mm² ±12 mm: S≥4.000N R≥48 N/mm² ±20 mm: S≥12.500N R≥48 N/mm² ±30 mm: S≥26.000N R≥48 N/mm²		
	RESISTENZA ALL'URTO IMPACT RESISTANCE - STOSSFESTIGKEIT RESISTANCE AUX CHOCES - RESISTENCIA A LOS GOLPES УДАРСТОЙКОСТЬ - 抗冲击强度	EN ISO 10545-5	VALORE DICHIARATO DECLARED VALUE	> 0,85		
	RESISTENZA ALL'ABRAZIONE ABRASION RESISTANCE - ABRIEBFESTIGKEIT RESISTANCE A L'ABRASION - RESISTENCIA A LA ABRASIÓN СТОЙКОСТЬ К ИСТИРАНИЮ - 耐磨强度	EN ISO 10545-6	≤ 175 mm³	< 145 mm³		
	COEFFICIENTE DI DILATAZIONE TERMICA LINEARE COEFFICIENT OF LINEAR THERMAL-EXPANSION - LINEARER WÄRMEAUDEHNUNGSKOEFFIZIENT COEFFICIENT DE DILATATION THERMIQUE LINEAIRE - COEFICIENTE DE DILATACIÓN TÉRMICA LINEAL КОЭФФИЦИЕНТ ЛИНЕЙНОГО ТЕРМИЧЕСКОГО РАСШИРЕНИЯ - 线性热膨胀系数	EN ISO 10545-8	—	α=6,1x10 ⁻⁶ °C ⁻¹		
	RESISTENZA AGLI SBALZI TERMICI RESISTANCE TO THERMAL SHOCKS - BESTÄNDIGKEIT GEGEN TEMPERATURSCHWANKUNGEN RESISTANCE AUX CHOCES THERMIQUES - RESISTENCIA A LOS CHOQUES TÉRMICOS СТОЙКОСТЬ К ПЕРЕПАДАМ ТЕМПЕРАТУРЫ - 耐热突变性	EN ISO 10545-9	TEST SUPERATO SECONDO EN ISO 10545-1 PASS ACCORDING EN ISO 10545-1	NESSUN DANNO NO DAMAGE		
	RESISTENZA AL GELO FROST RESISTANCE - FROSTBESTÄNDIGKEIT RESISTANCE AU GEL - RESISTENCIA AL HIELO МОРОЗОСТОЙКОСТЬ - 耐冻性	EN ISO 10545-12	TEST SUPERATO SECOND EN ISO 10545-1 PASS ACCORDING EN ISO 10545-1	NESSUN DANNO NO DAMAGE		
	RESISTENZA ALL'ATTACCO CHIMICO RESISTANCE TO CHEMICALS - CHEMIKALIENBESTÄNDIGKEIT RESISTANCE A L'ATTAQUE CHIMIQUE - RESISTENCIA QUÍMICA ХИМИЧЕСКАЯ СТОЙКОСТЬ - 耐化学品作用	EN ISO 10545-13	UB MIN.	NAT / SP A LA HA	SILK A LA HA	LUCIDO A LB
	RESISTENZA ALLE MACCHIE RESISTANCE TO STAINS - FLECKENBESTÄNDIGKEIT RESISTANCE AUX TACHES - RESISTENCIA A LAS MANCHAS УСТОЙЧИВОСТЬ К ПЯТНООБРАЗОВАНИЮ - 防污性	EN ISO 10545-14	VALORE DICHIARATO DECLARED VALUE	5		
	CESSIONE DI PIOMBO E CADMIO LEAD AND CADMIUM DISCHARGE - ABGABE VON BLEI UND CADMIUM PERTE DE PLOMB ET CADMIUM - CESIÓN DE PLOMO Y CADMIO ВЫДЕЛЕНИЕ СВИНЦА И КАДМИЯ - 铅和镉的排放	EN ISO 10545-15	VALORE DICHIARATO DECLARED VALUE	< AL LIMITE DI RILEVAMENTO < THAN INSTRUMENT LIMIT		

Per i certificati specifici, contattare Mirage SpA - For specific certificates, please contact Mirage SPA - Für die speziellen Zertifikate wenden Sie sich bitte an Mirage SpA - Pour les certificats spécifiques, veuillez contacter Mirage SPA
 Para los certificados específicos, contactar Mirage SPA - Для сертификатов обращайтесь в компанию Mirage SpA - 关于具体的证书，请联系Mirage SpA公司

RIASSUNTIVO FORMATI ED IMBALLI

Summary of sizes and packaging | Übersicht über Formate und Verpackungen | Récapitulatif formats et emballages
Sinóptico de formatos y embalajes | Краткая информация о форматах и упаковках | 规格和包装概述

BIG SIZES - 1200x1200 / 1200x2400 / 300x2400
BIG SIZES - 48"x48" / 48"x96" / 12"x96"

Imballo Packaging	Cassa 1200x2400: Ingombro: 268x135,6x35,8 cm Peso: 82 kg Crate 1200x2400: Overall dimensions: 268x135,6x35,8 cm Weight: 82 kg		Pallet + parietali 1200x1200: Ingombro: 143x123x63 cm Peso: 53 kg Pallet + sides 1200x1200: Overall dimensions: 143x123x63 cm Weight: 53 kg		Cavalletto da 36 lastre Ingombro: 250x75x159 cm Peso: 155 kg Stand containing 36 slabs Overall dimensions: 250x75x159 cm Weight: 155 kg		Cavalletto da 20 scatole Ingombro: 75x130x158 cm Peso: 60 kg Stand containing 20 boxes Overall dimensions: 75x130x158 cm Weight: 60 kg			
Formato Dimension	300x2400x9	1200x2400x9	1200x2400x20	1200x1200x9	1200x1200x20	1200x2400x9	1200x2400x20	1200x1200x9	1200x1200x20	

Kg pezzo Kg piece	-	58	134	29	67	58	134	29	67
Pezzi Pieces	72	18	8	40	20	36	18	40	18
Scatole Boxes	-	-	-	20	20	-	-	16	20
Mq Sqm	51,84	51,84	23,04	57,60	28,80	103,68	46,08	46,08	28,80
Kg Kg	-	1126	1156	1223	1403	2243	2302	970	1410
Tipo imballo Type of packaging	-			Scatola Box		-		Scatola Box	
Note Notes	Carico su camion: - sovrapponibilità max. su camion n.5 casse; - max. 20 casse su camion (5 spazi) compatibilmente con i limiti di peso totale; - possibilità di affiancare a ciascuna pila nr. 2 europallett; Loading on truck: - stacks of no more than 5 crates; - max. 20 crates per truck (5 spaces) in accordance with the total weight limits; - possibility to place 2 europalletts adjacent to each stack;			Carico su camion: - sovrapponibilità max. su camion n.3 casse (si consiglia n.2 casse); - max. 24 casse su camion (8 spazi) compatibilmente con i limiti di peso totale; Loading on truck: - stacks of no more than 3 crates (we recommend only 2); - max. 24 crates per truck (8 spaces) in accordance with the total weight limits;		Carico su camion: - max. 15 cavalletti su camion (15 spazi) compatibilmente con i limiti di peso totale; Loading on truck: - max. 15 stands per truck (15 spaces) in accordance with the total weight limits;		Carico su camion: - max. 30 cavalletti su camion (30 spazi) compatibilmente con i limiti di peso totale; Loading on truck: - max. 30 stands per truck (30 spaces) in accordance with the total weight limits;	

BIG SIZES - 200x2780 / 1200x2780
BIG SIZES - 8"x110" / 48"x110"

Imballo Packaging	Cassa 200x2780: Ingombro: 291,6x144,5x33,8 cm Peso: 88 kg Crate 1200x2780: Overall dimensions: 291,6x144,5x33,8 cm Weight: 88 kg		Cassa Leggera 1200x2780: Ingombro: 290x145x24 cm Crate Light 1200x2780: Overall dimensions: 290x145x24 cm		Cavalletto da 42 lastre Ingombro: 290x75x159 cm Peso: 120 kg Stand containing 42 slabs Overall dimensions: 290x75x159 cm Weight: 120 kg	
Formato Dimension	200x2780x6	1200x2780x6	1200x2780x6 Kit Vein Matching only	200x2780x6	1200x2780x6	1200x2780x6









Kg pezzo Kg piece	8,26	50	50	8,26	50	50
Pezzi Pieces	6	18	5 max	6	7	42
Scatole Boxes	18	-	-	5	-	-
Mq Sqm	60,05	60,05	-	16,68	23,35	140,11
Kg Kg	892,08	892,08	-	247,80	350	2220
Tipo imballo Type of packaging	-	-	-	-	-	-
Note Notes	Carico su camion: - sovrapponibilità max. su camion n.5 casse; - max. 20 casse su camion (5 spazi) compatibilmente con i limiti di peso totale; - possibilità di affiancare a ciascuna pila nr. 2 europallett; Loading on truck: - stacks of no more than 5 crates; - max. 20 crates per truck (5 spaces) in accordance with the total weight limits; - possibility to place 2 europalletts adjacent to each stack;			Carico su camion: - max. 12 cavalletti su camion (12 spazi) compatibilmente con i limiti di peso totale; Loading on truck: - max. 12 stands per truck (12 spaces) in accordance with the total weight limits;		

RIASSUNTIVO FORMATI ED IMBALLI

Summary of sizes and packaging | Übersicht über Formate und Verpackungen | Récapitulatif formats et emballages
Sinóptico de formatos y embalajes | Краткая информация о форматах и упаковках | 规格和包装概述

BIG SIZES - 1600x1600 / 1600x3200 / 1620x3240

BIG SIZES - 63"x63" / 63"x126" / 63¾"x127½"

									
Imballo Packaging	Cassa 1600x1600 Crate 1600x1600	Cassa 1600x3200 Crate 1600x3200	Cassa 1600x3200 Crate 1600x3200	Cavalletto da 48 lastre TIPO 2* Stand containing 48 slabs TYPE 2*	Cavalletto da 42 lastre TIPO 2* Stand containing 42 slabs TYPE 2*	Cavalletto da 22 lastre TIPO 2* Stand containing 22 slabs TYPE 2*	Cavalletto da 42 lastre Stand containing 42 slabs	Cavalletto da 22 lastre Stand containing 22 slabs	
Formato Dimension	1600x1600x6	1600x3200x6	1600x3200x12	1600x1600x6	1600x3200x6	1600x3200x12	1600x3200x6	1600x3200x12	
Ingombro Overall dimensions	183x174x41 cm	344x175x37 cm	344x175x37 cm	170x75x200 cm	330x75x200 cm	330x75x200 cm	335x75x195 cm	330x75x200 cm	
Peso Weight	91 kg	139 kg	139 kg	103 kg	206 kg	206 kg	176 kg	176 kg	
Kg pezzo Kg piece	38	76	148	38	76	148	76	148	
Pezzi Pieces	24	14	8	48	42	22	42	22	
Scatole Boxes	-	-	-	-	-	-	-	-	
Mq Sqm	61,44	71,68	40,96	122,88	215,04	112,64	215,04	112,64	
Kg Kg	1003	1203	1323	1927	3389	3462	3333	3432	
Tipo imballo Type of packaging	-	-	-	-	-	-	-	-	
Note Notes	Carico su camion: - sovrapposibilità max. su camion n.4 casse; - max. 28 casse su camion (7 spazi) compatibilmente con i limiti di peso totale; Loading on truck: - stacks of no more than 4 crates; - max. 28 crates per truck (7 spaces) in accordance with the total weight limits;	Carico su camion: - sovrapposibilità max. su camion n.5 casse; - max. 15 casse su camion (3 spazi) compatibilmente con i limiti di peso totale; - possibilità di affiancare a ciascuna pila nr. 2 spazi pallet tipo 63 cm x 123 cm ; Loading on truck: - stacks of no more than 5 crates; - max. 15 crates per truck (3 spaces) in accordance with the total weight limits; - possibility to place 2 pallets (type 63 cm x 123 cm) adjacent to each stack;	Carico su camion: - sovrapposibilità max. su camion n.5 casse; - max. 15 casse su camion (3 spazi) compatibilmente con i limiti di peso totale; - possibilità di affiancare a ciascuna pila nr. 2 spazi pallet tipo 63 cm x 123 cm ; Loading on truck: - max. 15 crates per truck (3 spaces) in accordance with the total weight limits; - possibility to place 2 pallets (type 63 cm x 123 cm) adjacent to each stack;	Carico su camion: - max. 21 cavalletti su camion (21 spazi) compatibilmente con i limiti di peso totale; Loading on truck: - max. 21 stands per truck (21 spaces) in accordance with the total weight limits;	Carico su camion: - max. 9 cavalletti su camion (9 spazi) compatibilmente con i limiti di peso totale; Loading on truck: - max. 9 stands per truck (9 spaces) in accordance with the total weight limits;	Carico su camion: - max. 9 cavalletti su camion (9 spazi) compatibilmente con i limiti di peso totale; Loading on truck: - max. 9 stands per truck (9 spaces) in accordance with the total weight limits;	Carico su camion: - max. 9 cavalletti su camion (9 spazi) compatibilmente con i limiti di peso totale; Loading on truck: - max. 9 stands per truck (9 spaces) in accordance with the total weight limits;	Carico su camion: - max. 9 cavalletti su camion (9 spazi) compatibilmente con i limiti di peso totale; Loading on truck: - max. 9 stands per truck (9 spaces) in accordance with the total weight limits;	Carico su camion: - max. 9 cavalletti su camion (9 spazi) compatibilmente con i limiti di peso totale; Loading on truck: - max. 9 stands per truck (9 spaces) in accordance with the total weight limits;

BIG SIZES - 1200x1200 / 1200x2400 / 300x2400 / 1200x2780 / 1600x1600 / 1600x3200 / 1620x3240

BIG SIZES - 48"x48" / 48"x96" / 12"x96" / 48"x110" / 63"x63" / 63"x126" / 63¾"x127½"



Container 20 piedi / 20' Container - 5,90 x 2,32 x 2,35(h) m	
Full 1200x2400	nr. 11 casse/crates 1200x2400 + 2 cavalletti/stands 1200x2400
Full 1200x1200	nr. 12 casse/crates 1200x1200x9 + 5 cavalletti/stands 1200x1200x9
Full 1200x1200	nr. 12 casse/crates 1200x1200x20 + 5 cavalletti/stands 1200x1200x20
Full 1200x2780	nr. 6 cavalletti/stands 1200x2780
Full 1200x2780	nr. 11 casse/crates 1200x2780 + 2 cavalletti/stands 1200x2780
Full 1600x3200	nr. 6 casse/crates 1600x3200 (+ 4 spazi/spaces 80 cm x 120 cm)
Full 1600x3200	nr. 3 cavalletti tipo 2/stands type 2 1600x3200 (+ 4 spazi/spaces 80 cm x 120 cm)
Full 1600x1600	nr. 15 casse/crates 1600x1600
Full 1600x1600	nr. 9 cavalletti tipo 2/stands type 2 1600x1600



Container 40 piedi / 40' Container - 11,90 x 2,32 x 2,35(h) m	
Full 1200x2400	nr. 12 cavalletti/stands 1200x2400
Full 1200x2400	nr. 21 casse/crates 1200x2400 + 4 cavalletti/stands 1200x2400
Full 1200x1200	nr. 24 casse/crates 1200x1200x9
Full 1200x1200	nr. 24 casse/crates 1200x1200x20
Full 1200x2780	nr. 12 cavalletti/stands 1200x2780
Full 1200x2780	nr. 21 casse/crates 1200x2780 + 4 cavalletti/stands 1200x2780
Full 1600x3200	nr. 16 casse/crates 1600x3200
Full 1600x3200	nr. 9 cavalletti tipo 2/stands type 2 1600x3200
Full 1600x1600	nr. 24 casse/crates 1600x1600
Full 1600x1600	nr. 19 cavalletti tipo 2/stands type 2 1600x1600

Camion, peso massimo caricabile / Truck, maximum loadable weight - 30 Ton.	
Full 1200x2400	nr. 20 casse/crates 1200x2400
Full 1200x1200	nr. 24 casse/crates 1200x1200
Full 1200x2780	nr. 20 casse/crates 1200x2780
Full 1600x3200	nr. 15 casse/crates 1600x3200
Full 1600x3200	nr. 9 cavalletti tipo 2/stands type 2 1600x3200
Full 1600x1600	nr. 27 casse/crates 1600x1600
Full 1600x1600	nr. 19 cavalletti tipo 2/stands type 2 1600x1600



Il calcolo deve tenere conto del peso (in modo da non eccedere i limiti di portata).
The quantities loaded must take into account the weight (in order not to exceed the maximum weight limits).

MIRAGE[®]
INSPIRING BETTER LIVING

Mirage Granito Ceramico S.p.a.

Uffici e Stabilimento
41026 - Pavullo (MO) ITALY
Via Giardini Nord, 225
Tel. +39 0536 29611
Fax +39 0536 21065
www.mirage.it

